



**GÖTEBORGS UNIVERSITET
HANDELSHÖGSKOLAN**

Bachelor Programme in Business Studies

Bachelor Thesis,

**Does the management communicate in a way
that is true to the financial statement?**

Bachelor Thesis

Emelie Davidsson 86

Anna Hamrin 88

Tutor:

Marina Grahovar

Business Economics / Accounting

VT2011

Acknowledgements

We would like to thank everyone supporting us in the process of making this thesis. Many thanks to our tutor Marina Grahovar and Gunnar Rimmel for being there for us with guidance throughout the process and helping us fulfil the purpose of the thesis.

We would also like to thank family and friends for being there for us.

Gothenburg, June 2011

Emelie Davidsson

Anna Hamrin

Abstract

Thesis title: Does the management communicate in a way that is true to the financial statement?

Background and problem description: Previous studies have shown that many Swedish private unlimited companies lack a lot of information in the MD&A. Due to the fact that the annual report, especially the narrative section, stands for an important part of the information used by investors and other stakeholders, it is vital that this information reflects a true and fair view of the company.

Purpose: The purpose of this thesis is to answer whether the management communicates in the MD&A in a way that is true to the financial statement, also if this communication reflects the company in a true and fair view.

Theoretical frame of reference: The foundation of the theoretical frame of reference in this thesis is different theories discussing how information is reflected in the narrative parts of the annual report. Some studies claim that the information tends to be biased towards positive tones, while others claim that the management communicate in a more truthful way. The last theory discussed in this chapter is the one claiming that willingness to present stable, unchanged information exists.

Methodology: The methodology used in this thesis was a content analysis. 152 MD&As of annual reports from the year 2009 of Swedish private unlimited companies were analysed to see how the management communicated.

Conclusions: The management uses techniques in the communication process that embellish the truth slightly. However, the empirical investigation showed that the MD&As overall reflected both positive and negative information, suggesting that the management has a willingness to present the company in a true and fair view. Thereby, it can be said that the management communicates in a truthful way. Even though the management's communication in the MD&A in some cases may be insufficient, the information reflects the company in a way that is true to the financial statement.

Recommendations for further research: To investigate the same companies during a time of prosperity, and see whether the same tendencies could be found and would strengthen the result of this investigation and contribute to previous studies. Another alternative would be to do a similar investigation on MD&As longer than five pages, to see whether the communication in these MD&As also reflects the truth and has the same tendency to be quiet. A final recommendation for further research would be to do a similar content analysis, but on another part in the narrative section of the annual report.

List of contents

Acknowledgements	2
Abstract	3
Chapter 1 Introduction	7
1.1 Background	7
1.2 Problem description	8
1.3 Problem statement	10
1.4 Purpose	10
1.5 Delimitation	10
1.6 Outline of the thesis	11
Chapter 2 Theoretical Frame of Reference	12
2.1 The Swedish MD&A	12
2.2 The communication process	12
2.3 The tone used in the communication process	15
Chapter 3 Methodology	20
3.1 Choice of methodology	20
3.2 Collection of data	20
3.3 Choice of annual reports	21
3.4 Mode of procedure	22
3.5 Pilot study	26
3.6 The quality of the methodology	28
Chapter 4 Empirical investigation	30
4.1 Result of the techniques used in the communication process	30
4.2 Result of the tone used in the communication process	31
4.3 Result of the MD&As not in accordance with the financial statement	36
Chapter 5 Analysis	39
5.1 Analysis of the techniques used in the communication process	39
5.2 Analysis of the tone used in the communication process	41
5.3 Analysis of the MD&As with no accordance with the financial statement	44
Chapter 6 Conclusion	47
6.1 The techniques used in the communication process	47
6.2 The tone used in the communication process	48

6.3	The MD&As that are not in accordance with the financial statement.....	48
6.4	Does the management communicate in a way that is true to the financial statement?.....	49
6.5	Recommendations for further research	49
List of references		50
Articles		50
Published references.....		52
Legal framework		52
Other references		52
Annual reports, 2009, electronic form.....		52
A. Appendix		55
A.1. Appendix. Complete list of the investigation.		55
A.2. Appendix. The name of the companies, which MD&As were used in the investigation.		61
A.3. Appendix. List of positive keywords (Clatworthy & Jones, 2003)		63
A.3. Appendix. List of negative keywords (Clatworthy & Jones, 2003)		65

List of figures

<i>Figure 1. Communication system (Shannon, 2001)</i>	12
<i>Figure 2. The first category, where the MD&As were in accordance with the financial statement, with the belonging groups. (Davidsson & Hamrin, 2011).....</i>	25
<i>Figure 3. The second category, where the MD&As were not in accordance with the financial statement, with the belonging groups. (Davidsson & Hamrin, 2011).....</i>	25
<i>Figure 4. The number of MD&As in accordance with the financial statement, making either losses or profits. (Davidsson & Hamrin, 2011).....</i>	34
<i>Figure 5. The second category, where the MD&As were not in accordance with the financial statement, with the belonging groups. (Davidsson & Hamrin, 2011).....</i>	35
<i>Figure 6. The number of MD&As not in accordance with the financial statement, in the five different groups. (Davidsson & Hamrin, 2011).....</i>	35
<i>Figure 7. The amount of MD&As (per cent) in accordance and not in accordance with the financial statement. (Davidsson & Hamrin, 2011).....</i>	44

List of tables

<i>Table 1. The result of the ten companies used in the pilot study. (Davidsson & Hamrin, 2011).....</i>	27
<i>Table 2. Economic overview of the company Icopal Aktiebolag (Icopal Aktiebolag, 2009; p.2)</i>	31
<i>Table 3. Economic overview of the company Östgöta Media AB (Östgöta Media AB, 2009; p.2).....</i>	31
<i>Table 4. The number of MD&As with a positive, negative, and neutral tone, as well as the amount of MD&As with no net difference. (Davidsson & Hamrin, 2011).....</i>	32

<i>Table 5. The companies with the highest net difference. (Davidsson & Hamrin, 2011)</i>	32
<i>Table 6. The companies with the lowest net difference. (Davidsson & Hamrin, 2011)</i>	33
<i>Table 7. The amount, the average, and the median of sentences. (Davidsson & Hamrin, 2011)</i>	34
<i>Table 8. Three of the companies making losses and presenting a positive tone in the MD&A. (Davidsson & Hamrin, 2011)</i>	36
<i>Table 9. Two of the companies making profits and presenting a negative tone in the MD&A. (Davidsson & Hamrin, 2011)</i>	37
<i>Table 10. One of the companies making losses and presenting a neutral tone in the MD&A. (Davidsson & Hamrin, 2011)</i>	37
<i>Table 11. Two of the companies making profits and presenting a neutral tone in the MD&A. (Davidsson & Hamrin, 2011)</i>	38
<i>Table 12. Two of the companies making (either profits or) losses and presenting an MD&A with no net difference. (Davidsson & Hamrin, 2011)</i>	38

Chapter 1

Introduction

In the chapter, the background of the investigation is declared and problems within the subject are discussed. This leads to a problem statement, which is connected to the purpose and is the main focus of the thesis. The chapter ends with an explanation of given delimitations together with an outline of the thesis.

1.1 Background

According to the Swedish Annual Accounts Act an annual report shall consist of: one balance sheet, one profit and loss account, footnotes, and a Swedish Management Discussion and Analysis (MD&A). The annual report for larger companies¹ shall also consist of a statement of cash flow. (2nd chap. 1 § Annual Accounts Act) The parts of the annual report shall together reflect the current state and result of the company, and show a true and fair view (2nd chap. 2, 3 § Annual Accounts Act)

The annual report can be divided into two different parts: the financial statement (composed of the balance sheet, the profit and loss account, the statement of cash flow, and related footnotes) and the narrative parts (consisting of the Swedish MD&A, President's Letter, and other narratives). (Rogers & Stocken, 2005)

The purpose of the Swedish MD&A is to complete the information given by the other parts of the annual report. The Annual Accounts Act regulates the content in the Swedish MD&A, but BFN U 96:6 and R_{ED}R1 chapter 3 may also be used as guidance. There are several elements, which have to be presented in the MD&A according to the Annual Accounts Act 6th chap. 1 §. To enhance the understanding of the annual report additionally information shall be presented in the Swedish MD&A. (6th chap. 1 § Annual Accounts Act)

Information that must be presented in the Swedish MD&A is the following:

1. The state of the company when it brings importance to the evaluation of the development, position and the result of the company and when it is not presented in the financial statement,
2. Significant events that are of importance to the company and which have occurred during or after the financial year,
3. The forecast of the company, including significant hazard that affects the company,
4. The research and development activity,

¹ Those who fulfil more than one of the following: have more than 50 employees, more than 25 million SEK in the balance sheet, or a net turnover of more than 80 million SEK.

5. Subsidiaries outside the country,

6-8. The value of the ratio and the number of possessed shares, acquisitions shares, and conveyed shares, and

9. Reasons for acquisitions, transformations or possession of the shares of the company. (6th chap. 1 § Annual Accounts Act)

The company shall also present non-financial information that reflects a fair view of the development, position and result of the company, this includes environmental effects that the company causes (6th chap. 1 § Annual Accounts Act).

Equivalents to the Swedish MD&A can be found in other countries as well. When preparing the annual report in the United States, the Generally Accepted Accounting Principles (GAAP) must be followed. Thereafter, the documents have to be improved by an accounting firm. The annual report must consist of a section called the Management Discussion and Analysis (MD&A), which aims to help the reader by reflecting on the financial statement of the company. (Yuthas; Rogers & Dillard, 2002) The MD&A helps the investors to see and study the company through the perspective of the management. (Morse, 1980) Among other things, the MD&A discusses sales, expenses from the operating part of the company and from the selling, and the administration section. It also gives information about changes and other trends that may affect sales and expenses now or in the future. (Yuthas; Rogers & Dillard, 2002) By looking at the content of the MD&A in the United States, a resemblance to the Swedish mandatory MD&A can be seen. To be consistent throughout the thesis, the choice of referring to the MD&A was made when talking about the Swedish MD&A.

The MD&A is the most used name for this section in the annual report, however in the United Kingdom it is called the Operating and Financial Review (OFR) (Beattie; McInnes & Fearnley, 2004). In Sweden it is often translated into Agency Report, Corporate Report, or Administration Report. The MD&A vary from country to country; it is named differently and its contents may vary. In some countries guidelines exist, while in others information is obligatory to present (Beattie; McInnes & Fearnley, 2004).

1.2 Problem description

The annual report gets more and more extensive for each passing year. Words are used more frequently; making numbers and tables a smaller percentage of the annual report. (Henderson, 2004) More than half of the information used by investors and analysts is provided from the annual report (Fulkerson, 1996; Rogers & Grant, 1997) and the investigation in the article of Fulkerson (1996) showed that stakeholders tend to have confidence in the information written in the annual reports.

The financial statement is far too complex for many investors. Consequently, investors find words easier to go through and thereby get much of their information from other sources than the financial section. (Henderson, 2004) The basic financial statement only contributes to one fourth of the information found in an average analyst report. (Rogers & Grant, 1997) The financial statements are of course an important part of the annual report, but there is evidence suggesting that especially the MD&A is the most useful part (Postman, 1953). The MD&A stands for the largest contribution and the narratives in total, account for about twice the information as the financial statement. (Rogers & Grant, 1997) Due to the readers' lack of knowledge of the financial section, many investors find it easier to focus on the narrative parts of the annual report, an example of this is the MD&A. The article published by Rogers and Grant (1997) explained that the MD&A is far more important than former investigations indicate. However, there are other investigations claiming that the financial statement is the most important part of the annual report. This is something that the authors have taken into account, but have chosen not to focus on.

The role of the narrative parts of the annual report is to create confidence and to shape information in a desired way (Aerts, 2001). The narratives are not audited, only reviewed by an outside auditor. The lack of regulation may result in the use of a more subjective method; different companies give different types of information. (Rowe, 1998) Previous investigations showed that companies tended to disclose both positive and negative information (Abrahamson & Amir, 1996; Skinner, 1994; Yuthas; Rogers & Dillard, 2002), while other investigations showed that companies embellished the truth and gave more positive information (Eiker; Hefzi & Glezen, 2000; Rutherford, 2005; Thomas, 1997). Some also claimed that the information given in the annual reports tended to be similar year after year, no matter how good or bad the performance of the company had been. This indicates that companies have the possibility to choose what kind of message they would like to share with the reader. (Aerts, 2001)

At the request of The Swedish Accounting Standards Board, *Öhrlings PricewaterhouseCoopers* studied the annual report of 100 private unlimited companies² from the year 2002. The result of the investigation revealed that many companies did not follow the Annual Accounts Act and did not reflect the company in a true and fair way. In the year 2006, Törning and Ericson (2006) followed-up the investigation aiming to find out if the way that the companies were portrayed had improved or not.

Both investigations revealed that the MD&A stood for the major deficiencies. The problem was that many of the MD&As investigated only contained a description of the business, an economic overview, together with a disposition of surplus. In the latest study the conclusion was drawn that the annual reports had improved, but that they were still missing a lot of information. (Törning & Erikson, 2006)

² 10/24-companies (at least: 10 employees and 24 000 000 SEK in annual turnover)

1.3 Problem statement

The annual report, especially the narrative section, stands for an important part of the information used by investors. It is thereby vital that this information should reflect a true and fair view of the company, as is the aim of the financial statement. Due to the result shown in earlier investigations, that many Swedish private unlimited companies lacked a lot of information in the MD&A, the authors find it of great importance to do a further investigation.

With this in mind we ask ourselves:

- Does the management communicate in a way that is true to the financial statement?
 - *Which techniques are used in the communication process?*
 - *How is the overall tone in the MD&A in comparison to the financial statement?*
 - *In case of no accordance between the MD&A and the financial statement, how is the information presented in the MD&As and is it possible to see any tendencies or reasons explaining the lack of accordance?*

1.4 Purpose

Even though the management may not present all information available, it can be of interest to see whether they communicate in a way that is true, by presenting the same information in the MD&A as in the financial statement. This may be discovered by analysing the techniques used by the management and by doing an analysis of which tone that is reflected in the MD&A. In case of no accordance between the tone in the MD&A and the information given in the financial statement, the aim is to do a further investigation to see whether any tendencies or reasons can be found explaining this lack of accordance.

1.5 Delimitation

In this study we assume that the financial statement overall reflects a true and fair view of the company and therefore we do not aim to analyse whether the annual report in total reflects upon the company in any other way. The purpose of this investigation is instead to examine whether the management communicates in a way that is true to the financial statement. In the investigation, sentences will be analysed in 152 Swedish private unlimited companies' MD&As in the annual report from the financial year of 2009. Only the information given in the MD&A reflecting the companies' financial year will be analysed to answer the problem statement.

1.6 Outline of the thesis

Chapter 1 – Introduction

In this part, the following sections are explained: background to the investigation, the problem description, the problem statement, the purpose and the delimitations.

Chapter 2 – Theoretical Frame of Reference

The chapter describes the theories used in this investigation, which later on will be compared to the empirical findings.

Chapter 3 – Methodology

This chapter explains the investigation's mode of procedure.

Chapter 4 – Empirical investigation

This chapter declares the result of the empirical investigation. The result is presented in three different parts/headlines, which follows the three sub-questions in the problem statement.

Chapter 5 – Analysis

The empirical findings are in this chapter compared with the Theoretical Frame of Reference. Also, this chapter consists of three parts, representing the three sub-questions from the problem statement.

Chapter 6 – Conclusion

This chapter will discuss the analysis and conclude the result of the investigation, by answering the problem statement.

Chapter 2

Theoretical Frame of Reference

This chapter presents the Theoretical Frame of Reference used in the investigation. First, the aim of the Swedish MD&A is presented in order to give the reader further knowledge of the subject. The communication process in the MD&A is explained and techniques used by the management are illustrated. Thereafter, the theory discusses different tones of the MD&A that are being used in the communication process.

2.1 The Swedish MD&A

As discussed in the background, the Swedish MD&A shall supplement the information given in the other parts of the annual report. Together, all the parts aim to present the actual state of the company in a comprehensive way. The MD&A shall present a true and fair view of the development, position, and result of the company, however, the amount of information depends on size and complexity. The MD&A shall also give significant reasons explaining the actual state and result of the company. Changes in production, raw materials supply, interest, exchange rate, and changes on the market shall be discussed and explained in terms of how they affect the company. (3rd chap. R_{ED}R1)

2.2 The communication process

Accounting is a form of communication process (Bedford & Baladouni, 1962). A general communication system consists of five components (figure 1). The first is some sort of information, which contains a message. To communicate the message further, the second component, a transmitter, has to reconstruct the message into a signal. The message is then sent as a signal through a channel. A noise source, the third component, is also involved within the channel before the signal reaches a receiver, the fourth component, which reconstructs the signal into a message. Finally, the message is communicated to the intended destination, the fifth component. (Shannon, 2001)

Figure 1. Communication system (Shannon, 2001)

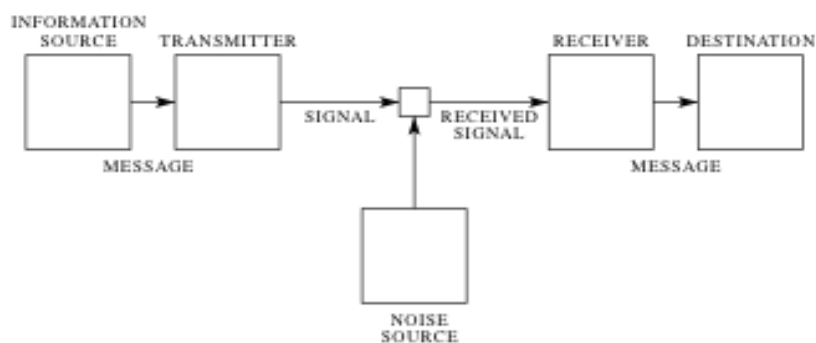

In our case the sender within the communication model is the management of the company. The assignment of the management is to give the actions of the company legitimacy and to offer explanations of the development (Pfeffer, 1981). The message from the management is formally written by the person signing the message. However, technically it is written by different people in the top management. The intended destination of the compounded message is the reader of the annual report and the MD&A. According to previous studies the readers consist of all different types of people interested in the development of the company. There are not only investors and stockholders reading the MD&A, but also other stakeholders such as clients and competitors. (Thomas, 1997) Companies have, according to law, a responsibility to consider the interest of all the stakeholders (Yuthas; Rogers & Dillard, 2002). Furthermore, the channel, from where the signal is transformed, is recognised as the annual report. The information in the MD&A is the signal transformed into a received message.

A central problem within the communication process is the reproduction part where the information is transformed into a message (Shannon, 2001). The sender of the message has an important role to fill. When reproducing the message to the receiver, the communicator has to question what and how to communicate, thus the content and the media of the message are necessary dimensions the communicator has to consider. (Bedford & Baladouni, 1962) The message itself may have many possible translations due to the fact that the sender can choose what he or she wants to communicate (Clampitt, 2005; Shannon, 2001) It is also argued that the communicator has a rhetorical choice in how to express the message, thereby the intended meaning can be translated into a different one depending on which technique is being used in the communication process. The language may differ depending on the values and emotions of the communicator. (Katz, 2001)

When it comes to analysts' forecasts, the information given may influence the reader by the tone and type of information disclosed (Rutherford, 2005). Although the message to a high extent depends on the use of language of the communicator, it is also argued that the comprehension of the received message depends on the capability of the receiver and his or her overall equipment. For example, the understanding of the content of a written sentence is to a high degree dependent on whether the reader understands the language or not but also if the reader has access to the sentence's source. (Rogers & Stocken, 2005) To fully comprehend the message, the understanding of the whole text is of importance for the reader. The reader might have to read between the lines when the information in the message is not clearly communicated. (Shannon, 2001)

2.2.1 The techniques used in the communication process

The management uses a type of language that is based on its own assumptions, resulting in a communication problem (Katz, 2001). Problems can also arise in the process of communication due to the fact that the message is manipulative, in other words aiming to mislead the reader's understanding of the performance of the company. (Bedford & Baladouni, 1962) A use of passive words like "being" is desirable when the writer wants to distance him or herself from the information given. Another alternative is to use relational

process verbs, such as “have”, “is”, or “are”, which gives the message a more objective tone. These two types of writing techniques can be used when the information is negative and the writer only wants to state the fact and then distance him or herself from it. (Thomas, 1997)

The lack of disclosure often depends on whether the company is making a profit or a loss. Clarkson, Kao, and Richardson (1994) came to the conclusion that companies making profits did not give much information due to the fact that they operate in a market with many competitors. Companies making losses chose not to give information because they did not want to spoil their possibility of reaching new financiers. However, the neglecting of information can also have a negative impact on the company. Investigations have shown that the reader may question the credibility of the rest of the information in the annual report (Davis; Piger, Sedor & Louis, 2006; Deegan & Rankin, 1996). In order to create and maintain a good reputation the company needs to become consistent when disclosing information, resulting in more reliability. (Gibbins; Richardson & Waterhouse, 1990)

Due to the fact that information itself or even the lack of it influences an outsider’s knowledge of and insight into the economic conditions of the company, it is of great importance to stakeholders. Lev (1992) found that a permanent information gap exists between the insiders and outsiders of the company when the management chooses not to disclose new information. However, other investigations question whether slanted information or lack of information in any way is able to influence the reader. Rutherford (2005) refers to financial analysts as being important readers of the annual report and questions the sender’s ability to fool these educated readers.

Investigations also show that the amount of information disclosed depends on whether the cost is less than the benefits associated with the disclosure (Bettman & Weitz, 1983; Clarkson; Kao & Richardson, 1994) Another empirical investigation made on annual reports of Swedish companies showed that the amount of disclosure depended not only on the size of the company but also on whether the company was listed or not. A large listed company ought to present more information than a smaller non-listed company. (Cooke, 1989).

Empirical studies have revealed that disclosing negative information tends to have a large negative effect on stock prices (Hutton; Miller & Skinner, 2003; Skinner, 1994), whereas presenting positive information only affects to a small extent, suggesting that the reader has a higher trust in negative information than that being positively presented (Skinner, 1994). The investigation by Hutton, Miller, and Skinner (2003) showed that to get a positive effect on stock prices the information must be verified. However, a supplement to the bad disclosure had no effect whatsoever on the credibility of the company’s information. This is due to the fact that bad news tends to be more trustworthy and thereby the need for verification does not exist (Hutton; Miller & Skinner, 2003), arguing that bad news is more reliable than good news (Rogers & Stocken, 2005). In the investigation made by Hutton, Miller, and Skinner (2003) a verification of a positive forecast had a positive effect on stock prices by 3.84 per cent, while almost no effect was detected when no verification was presented, concluding that the credibility of good news is much higher when being verified by a supplement.

There are several empirical studies suggesting that the management has a tendency to blame failures on the environment. (Bettman & Weitz, 1983; Salancik & Meindl, 1984; Staw et al., 1983; Thomas, 1997). The investigation made by Thomas (1997) showed that even though a desire to embellish the truth does not exist, a tendency to present the management as favourably as possible can be found. The management tends to claim that the failures are beyond their responsibility.

2.3 The tone used in the communication process

2.3.1 Positive communication

The Pollyanna hypothesis is based on the book written in the year 1913, about a girl named Pollyanna. Pollyanna has become a name used for people with great optimism. The term means a refusal to see the negative in life and a choice to see positivity and sunshine. (Hildebrandt & Snyder, 1981) According to the Pollyanna hypothesis there is a tendency to communicate more positively-charged words at a higher frequency than negatively-charged words (Boucher & Osgood, 1969).

Hildebrandt & Snyder (1981) investigated whether the Pollyanna hypothesis could be identified within business communication as well. Twelve Annual Letters to Stockholders were investigated during two different years with the aim of seeing if positive words were used more frequently than negative words, without any consideration to whether the company made a profit or loss. The authors also wanted to see if a difference could be seen in the way companies making profits or losses used negative words, assuming that the loss-making companies used more negatively-charged words. According to the authors, previous studies have investigated the Pollyanna hypothesis in different ways. For example, Postman (1953) came to the conclusion that positive words were used with higher frequency than negative words. The investigation made in the year 1981 concluded that positively-charged words were used more frequently than negative words, no matter how good or bad the year had been. They also found that negative words were used with less frequency in good years than during bad years, which corresponds with the Pollyanna hypothesis. (Hildebrandt & Snyder, 1981)

Clatworthy and Jones (2003) investigated the Chairman's Statement (in other words the MD&A) in the annual report of 100 United Kingdom listed companies. Half of the companies were at the bottom of the list, while the other half were at the top. The authors came to the conclusion that the management of the good-performing companies tended to give positive information and that the ones of the bad-performing companies had a tendency to avoid talking about the bad result. However, some of the Chairman's Statements of bad-performing companies disclosed information that usually included both positive and negative news. Some Chairman's Statements discussed only positive news, suggesting that the information given tends to have a more positive tone even in bad-performing companies. (Clatworthy & Jones, 2003)

Investigating the British Operating and Financial Review (OFR) Rutherford (2005) found that the Pollyanna hypothesis was highly presented when the OFR was constructed, being especially strong in the section referring to the financial performance. The author found that companies to a greater extent referred to profits and assets rather than to losses and liabilities. The OFRs were more often filled with words with a positive association and “up”-words such as “increase”. The high frequency of “up”-words could, according to Rutherford, be an effect of a continuous rise of price levels and the fact that many economies were expanding. On the other hand, due to the huge amount of “up”-words found, the Pollyanna hypothesis ought to be presented. Further, there were no differences to be found in the way companies with lower profits and companies with higher profits presented degradations. They used more or less the same amount of negative words. However, the overall findings proved that the Pollyanna hypothesis, earlier observed in unregulated accounting narratives, could also be found in sections characterized by clearer guidelines stating that the tone should be neutral. (Rutherford, 2005)

Thomas (1997) aimed to investigate annual reports of companies making either profits or losses to see how the communication of the management was construed. Annual Letters to Stockholders was investigated and the conclusion was drawn that the Pollyanna hypothesis was presented, but that the communication in these reports had more to it and depended on the management’s choice to position the company. The author found that the companies tended to communicate with more passiveness in the years making losses than in the years making profits, revealing the aim that managers had to distance themselves from the message. (Thomas, 1997)

By investigating forward-looking information from 25 randomly selected companies’ MD&As Pava and Epstein (1993) came to the conclusion that overall the companies did a good job of prognosticating positive future trends, whereas negative future information seldom was fully disclosed and sometimes not even discussed. Thereby the investigation concluded that the MD&As were presenting good news in a more accurate way than they did with bad news. This affects the overall use of the forward-looking information in the MD&A to the analyst making forecasts. (Pava & Epstein, 1993)

Deegan and Rankin (1996) focused their investigation on how loss-making companies chose to present their environmental information in the annual report. Previous investigations made in Australia showed that the environmental information presented, tended to be biased to the extent that it was favourable to the image of the company. The authors examined the environmental information left by 197 randomly selected companies. By counting words they found that the mean amount of positive disclosure was about 31 times as many as the amount of negative information given. It also was revealed that only 14 companies presented any negative environmental information. Thereby concluding that companies tend to disclose information that is positive and hold back on information that is negative, in the aim to represent themselves in a way that has a positive effect on their image. (Deegan & Rankin, 1996)

The investigation by Rutherford (2005) revealed that companies making losses used the word “profit” more times than they used the word “loss”, this to the extent that they even topped the companies making slight profits. This finding supplements the previous study made by Deegan and Rankin (1996) by suggesting that disclosures tend to a greater extent be of a positive character. The investigation indicates that the Pollyanna hypothesis is to a larger extent presented within companies making losses. (Rutherford, 2005)

2.3.2 Trustworthy communication – positive and negative information

The study made by Yuthas, Rogers, and Dillard (2002) aimed to investigate if the information given in the annual reports was reliable or only a way to influence the reader, the stakeholders or others, to behave in a way that suits the company. The authors expected the results to be that companies with negative information tended to bend the rules to avoid presenting them with the aim to embellish the view of the company, while companies with positive information tended to follow the norms better. However, the result showed that the companies presenting either positive or negative information communicated it in a more truthful manner than those who had no large information disclosures to report. Regarding the historical information given in the MD&As, investigations made by Pava and Epstein (1993) showed that this type of information overall was presented in an accurate way.

Yuthas, Rogers, and Dillard (2002) argued that in the short run it can be harmful for companies to reveal negative information due to its affect on the market valuation of the company. However, it is argued that in the long run it ought to be in the company’s interest to disclose both positive and negative information, otherwise the trust may be harmed. The authors discovered that the readers trust the information given in the annual reports and are expecting it to reflect the company in a true and fair view. By embellishing the truth the readers may start to question the credibility of the company. Credibility is given more importance than strategic communication in the annual reports (Yuthas; Rogers & Dillard, 2002), this due to the importance the reader places on legitimacy which is perceived as meaningful and a sign of trust (Suchman, 1995). However, it is stated that the information in the narrative parts is in a way designed to influence the investor’s view of the company, a form of a public relations stunt. (Yuthas; Rogers & Dillard, 2002) As mentioned before, the fact that slanted information or lack of information is able to influence the reader has been questioned and the reader should have the ability to understand the sender’s bad intention. (Rutherford, 2005)

By investigating 93 randomly selected companies, Skinner (1994) revealed that companies voluntarily tend to give both positive and negative information. The aim of the disclosure of positive information is a way to differentiate from those companies that do not perform as well (Lev & Penman, 1990). The intention for revealing negative information is normally related to the fact that the company according to law has to present certain information, but also due to the fact that the company do not want to harm their reputation by not telling the truth. (Skinner, 1994)

Abrahamson and Amir (1996) made a content analysis of the information given in 1325 President's Letters. The conclusion was drawn that the information given in this narrative part of the annual report was indeed correlated with the information given in the financial statement, indicating that a trustworthy communication is used in the President's Letter. The investigation showed that the negative information was often disclosed due to the accountants', and some shareholders' and director's way of exhorting managers to bring forth the information. (Abrahamson & Amir, 1996)

An empirical investigation made by Rogers and Stocken (2005) showed that the management's choice to slant forward-looking information depended on the capability of the market to discover this information. The management has a natural intention to slant information, but if the risk of being exposed is high, such as on a successful market, the truthfulness will be presented. The investigation showed that on successful markets the management does not dare to give incorrect information, not even information that is a bit slanted. (Rogers & Stocken, 2005)

According to an investigation made by Clarkson, Kao, and Richardson (1994) findings indicated that the management of loss-making companies tended to decrease the number of forecasts given when the interest to attract financiers was high, whereas forecasting increased in times of severe competition. A large number of companies making profits chose not to forecast, while many companies making losses chose to forecast, which indicates that there is more to discuss within the subject of whether companies choose to forecast or not. In other words these two findings suggest that there is more to it than just wanting to present the company in a good way. (Clarkson; Kao & Richardson, 1994) However, as mentioned earlier, the investigation made by Yuthas, Rogers, and Dillard (2002) found that companies regardless of the result tended, to a great extent, to give both positive and negative information, this due to the importance of legitimacy.

2.3.3 Neutral communication

Performance stability within a company has become an important factor to the investors and the management of the company due to the fact that it is seen as a sign of ability to return investments. Because of this attraction to stability, there is a risk that the management act ritualistically and that the MD&A among others will be unchanged over time. (Aerts, 2001)

Considering listed companies, the aim in the annual report is to give information that results in as little negative effect as possible on the stock price (Aerts, 2001). It is also stated that the MD&A ought to be neutral, not being too positive nor too negative (Pava et al, 1993). The MD&A shall create a confident surrounding with the aim to neutralize the sensitive information and avoid unnecessary surprises affecting the stakeholders. The management tends to give different information depending on whether the message aims to reach the internal company or the external surroundings. Evidence shows that the companies investigated by Aerts (2001) did not include internal stated information in the MD&A. Due to the varying information given, there is a risk that the image of the company will be misled.

As mentioned before, an investigation made by Clarkson, Kao, and Richardson (1994) showed that companies with bad news tended to decrease the information given in the annual reports, resulting in a more neutral tone. A further finding was that the forecast information in companies making a profit decreased in the presence of threats from competitors, also making this message neutral. According to Lev and Penman (1990) companies that are too neutral, in other words making no disclosure at all, tend to decrease their company value on the market. This is due to the fact that stakeholders normally translate non-disclosures as bad news and a sign that the company does not present the whole truth. Clatworthy and Jones (2001) came to the conclusion that loss-making companies tended to avoid discussing the reason for their bad performance and instead they tended to give both positive and negative information.

In addition to the discussion above the investigation made by Clarkson, Kao, and Richardson (1994) also suggested that loss-making companies disclosing forecasts tended to get less financing than the companies that chose not to forecast. It was also revealed that there were no differences between the amounts of financing companies making losses or profits got when choosing not to forecast. This suggests that silence can be used with success when the company is making a loss. (Clarkson; Kao & Richardson, 1994)

Chapter 3

Methodology

This chapter starts by explaining the choice of methodology, the collection of data, and the given delimitations regarding the annual reports being used in the investigation. The mode of procedure of the investigation is explained and leads to a description of the pilot study. Finally, the chapter ends with a discussion of the quality of the methodology chosen.

3.1 Choice of methodology

The purpose was to investigate if the management communicated in a way that was true to the financial statement. Due to the fact that the focus lay upon the communication process in the MD&A, which is a written part of the annual report, the choice of doing a textual analysis was a natural decision. A textual analysis has many advantages, in this investigation the most important reason for choosing the method was its use of objective measures. Using a textual analysis, specific events can be counted without any alternative motives, which is an indication of objectivity. (Jonäll, 2006) There are different types of methods within the textual analysis, one is a content analysis that was used in the investigation. A content analysis can be used to discover patterns in written texts where the sample size is relatively large. The analysis can be made manually or with the help of textual-analysis software. A manual analysis is to be preferred if the aim is to do a more complex judgement within the investigation. Knowledge of how something is being communicated in a text is often of interest when using this type of analysis. These recent statements clarify the choice of doing a manual content analysis. Within a content analysis, positive and negative-charged statements can be discovered and counted. (Bergström & Boréus, 2005) The method of doing a content analysis, has been used frequently in previous empirical investigations, such as the one made by Hildebrandt and Snyder (1981), Rogers and Grant (1997), Abrahamson and Amir (1996), Deegan and Rankin (1996), Clatworthy and Jones (2003), and Rutherford (2005).

3.2 Collection of data

The database *Retriever* was used to be able to collect the necessary data. The advantage of using *Retriever* was that it gave access to annual reports of private unlimited companies and also that it was available through the *University of Gothenburg*. The collection of data consisted of MD&As in annual reports of the Swedish private unlimited companies. We made an advanced search where a minimum amount of employees and a minimum annual turnover was chosen, see 3.3 *Choice of annual reports*. Since the aim was to investigate whether the MD&As were in accordance with the financial statement, the information given in the MD&A reflecting the financial year of 2009 was analysed. The focused lay upon finding how the management communicate with words, whereas figures, charts, and other tables were excluded from the investigation.

3.3 Choice of annual reports

The article written by Törning and Ericson (2006) came to the conclusion that the annual reports of Swedish private unlimited companies had improved since the last investigation, but that they were still missing a lot of information, especially in the MD&A. With this article in mind, the aim was to examine the annual reports of the 96 companies again and compare the result. After several attempt to acquire the material of previous studies, it was revealed that the information was not to be found according to Törning and Ericson. The focus of this investigation was still to analyse the MD&As of Swedish private unlimited companies due to the interest of knowing if the MD&As despite possible errors still reflected the same information as the financial statement. Since an interest of doing a similar investigation as the one of Törning and Ericson (2006) existed, companies with more than 10 employees and more than 24 million SEK in the balance sheet were selected. In that way, the rule of “10/24-company” was followed. The problem arose when investigating the smaller companies since the majority of these MD&As did not present enough information.

When making an advanced search in *Retriever* different delimitations can be made. The possible choices in the investigation, doing the retriever advanced search, was to select companies with more than 50 million SEK in annual turnover or more than 500 million SEK. Due to the lack of information in the MD&As of smaller companies, the larger category was chosen. It seemed likely that these companies presented more information in the MD&A, since they ought to present more due to its size and complexity (3 chap. REDR 1). Normally, the more information given in the MD&A, the better the analysis. With the regulation in mind, companies of the same size shall present the same amount of information, thereby the choice was to analyse annual reports of companies with a more or less equal annual turnover.

Finally, 152 MD&As of Swedish private unlimited companies were analysed (see A.2. Appendix). In order to make a statistical survey, a random sample of companies was selected and analysed to be able to draw a conclusion of the population. (Newbold; Carlson & Thorne, 2002) Therefore the only criteria were, that the selected companies had an annual turnover of 500 million – 600 million SEK and more than ten employees. MD&As in annual reports from the financial year of 2009 were selected, since not all of the companies had presented their annual report of the financial year of 2010. The annual reports were selected regardless of whether the financial year was split or not. Worth mentioning is that these annual reports are written after the financial crisis and that many companies still suffer from the depression. This can be seen as an advantage since an interest of knowing whether the management of profit and loss-making companies communicated in a way that was true to the financial statement existed.

In total, the investigation had a falling off of 25 annual reports. These annual reports were excluded since they did not fulfil the criteria of the investigation. Annual reports of companies with a profit of zero were excluded since they tended to be assigned group contributions but had no other activities that could be analysed. Annual reports of companies with no activity and thereby no income, were also excluded due to the fact that these companies did not have any information about the financial year to present in the MD&A. Others that in the MD&A

focused on the group to which the company belonged, were excluded from the investigation due to the fact that this would be misleading when they chose to write about things that did not concern the company in question. Furthermore, companies that had an MD&A longer than five pages were excluded since the aim was to analyse MD&As of a similar length.

3.4 Mode of procedure

When doing a content analysis and other types of textual analysis certain knowledge of the subject is necessary (Bergström & Boréus, 2005), therefore the law and praxis regulating the content of the MD&A was studied. Thereafter, the 152 MD&As were reread to get a sense of the information given in this specific part of the annual report, which ought to facilitate the analysis (Bergström & Boréus, 2005). The content analysis made in the empirical investigation was made in three different stages and declared in three different parts.

3.4.1 An analysis of the techniques used in the communication process

In the first stage of the investigation, the MD&As were once again reread to get a sense of how the management communicated their message in the MD&A. The aim of this first part was to see which techniques the management used in the communication process in the MD&A. This qualitative analysis aimed to find how the communication process was constructed and which techniques the management used when disclosing information. The focus was to see if for example passive words or relational process verbs were used, as discussed in the theoretical frame of reference. Another example of objects analysed, was the parts in the MD&A where the language indicated a manipulative communication. One example was the management's way of communicating negative information of the financial year in a distorted way. These findings were then compared with the theoretical frame of reference to be able to analyse the empirical discovery. Together with the theoretical frame of reference, this part of the investigation helped the authors to answer the first sub-question in the problem statement. It also facilitated the parts that followed within the empirical investigation in the sense that it gave some clarity concerning which techniques the management used in the communication process in the MD&A.

3.4.2 A content analysis of the tone used in the communication process

The second part of the empirical investigation aimed to focus on the tone used by the management in the MD&A. Therefore, a quantitative content analysis was made. To discover the tone in the MD&As the focus lay upon finding positive, negative, and neutral information, which has been done in similar ways in previous empirical investigations, like the one made by Hildebrandt and Snyder (1981) and Abrahamson and Amir (1996). Hildebrandt and Snyder (1981) made a quantitative content analysis where positive and negative words in context were analysed, meaning that the words were not seen in isolation. This technique was also used in this investigation since the focus was to analyse the overall tone in the MD&A. Another reason for analysing the whole sentence was that charged words may fool the result when a positive word occurs in a negative sentence or the other way around. However,

charged words helped to create a first impression of the sentence but it was the words all together; the whole sentence, that made it positive, negative or neutral.

Abrahamson and Amir (1996) focused their content analysis on finding negatively-charged words using a list of negative keywords. This list contained “words with clear negative connotation such as ‘loss(es)’, ‘problems(s)’, and ‘difficult’...” (Abrahamson & Amir, 1996; p.1161). With this in mind, the idea was to seek similar lists of both positive and negative words, which could be used as a guide for the detection of sentences worth analysing. The lists of positive and negative keywords used in this investigation were based on the lists used by Clatworthy and Jones (2003). (A.3, A.4. Appendix) However, these lists were only used as guides, in reality the investigation used more words to be able to cover all sentences that reflected the companies’ financial year in a positive or negative way. Some common negative and positive words or grammatical variations were not presented in the lists of Clatworthy and Jones (2003), which also strengthens the choice to use a wider range of words. The aim of these words was to use them as a guide to be more certain that the two persons doing the encoding made it in the same way. As stated by Bergström and Boréus (2005), it is of great importance that the estimations are made in a similar way, otherwise the findings may be a result of different estimations of the people encoding the material. In case of any disagreements, the coders came to an agreement by discussing the sentence. Additionally, a way of minimizing the risk of subjective estimations is to encode the material twice, which was made in the investigation. By encoding the material twice a higher guarantee can be given that it is possible for a different researcher to be able to do the same investigation and reach the same result. (Bergström & Boréus, 2005)

The sentence had to meet certain criteria to be categorized as relevant and encoded into the investigation. The criteria were the following:

- The sentence had to be complete, in other words it had to end with a dot
- The sentence had to refer to something that happened during the financial year of 2009 and concerned the company in question
- The sentence had to refer to something that affected the financial statement, in other words affecting the result of the financial year
- The sentence also had to contain a positive, negative, or neutral keyword

Some example sentences are given, to give the reader an understanding of the coding scheme. Examples of sentences analysed were the following: “The net sales amounted to 544 MSEK, an increase by 4.9 % in comparison to the previous year.” (TeknikMagasinet Sweden Aktiebolag, 2009; p.1), which was categorized as a positive sentence due to the fact that it had a positive tone and included the word “increase” (A.3. Appendix). “The recession beginning at the end of the year 2008...is estimated to have a further negative effect on the sales volume” (EFG European Furniture Group Aktiebolag, 2009; p.3), was categorized as a negative sentence due to its tone and the use of the word “negative” (A.4. Appendix).

Sentences referring to the future or the past were excluded. The same thing happened to the sentences referring to the change of CEO, employees, research and development, and environmental information, these changes did not seem to have any obvious impact on the financial result. For example, “According to the emission licence the company may dump metals into the water, something that the company has not taken advantage of.” (Lindab, 2009; p.3), was excluded because the event did not indicate any obvious effect on the financial result. A sentence that was both positive and negative, for example in the annual report of *UNIT4 Agresso*: “EBITDA finally ended at 52 billion and the EBT at 38.2 billion, somewhat lower than last year, but good numbers on a tough market.” (UNIT4 Agresso, 2009; p.2) was in the investigation counted two times, one as positive and one as negative. A sentence such as: “Even though the company presents a loss, it was on a level with the budget.” (Berner & Co, 2009; p.2) indicated a negative tone even if the information was embellished.

Before starting with a larger investigation it may be clever to analyse a smaller text sample, this can help the researchers find which parts of the text are relevant to analyse (Bergström & Boréus, 2005). A pilot study was made, as a sample analysis. The aim of the smaller study was to follow the same principles applied in the entire investigation, by doing this, pitfalls may be detected and correction can be made at an early stage of the investigation. For further information see 3.5 *Pilot study*.

To get back to the second part of the investigation, after all the sentences had been categorized and encoded, the next step was to count the amount of positive, negative, and neutral sentences, this to be able to reach a final value of the MD&A. This net difference was calculated as the difference between the positive and negative sentences, while the neutral sentences were given the value zero. The final net difference of the company was compared to the profit or loss of the year to see whether the MD&A gave the same type of information as the financial statement, suggesting that the MD&A reflects the company in a true and fair view. To get a sense of how substantial a profit or loss was, it was compared to the shareholders’ equity. By doing this, we will be able to see whether the result is as good (bad) as the net difference indicates. The total amount of sentences in every MD&A was also counted to get a sense of how rich in information the MD&As were. In order to reach a final result Excel was used to do the calculations and produce tables.

To be able to analyse the result of the empirical investigation the MD&As were sorted into two different categories: one was the MD&As that were in accordance with the financial statement and another was the MD&As that differed from the financial statements. Within these two categories several groups could be found that indicated different outcomes. In the first category, containing MD&As which were in accordance with the financial statement, two different groups could be found, one where the companies made profits and had an MD&A in an overall positive tone, and another where the companies made losses and had a negative tone in the MD&A. (Figure 2)

Figure 2. The first category, where the MD&As were in accordance with the financial statement, with the belonging groups. (Davidsson & Hamrin, 2011)

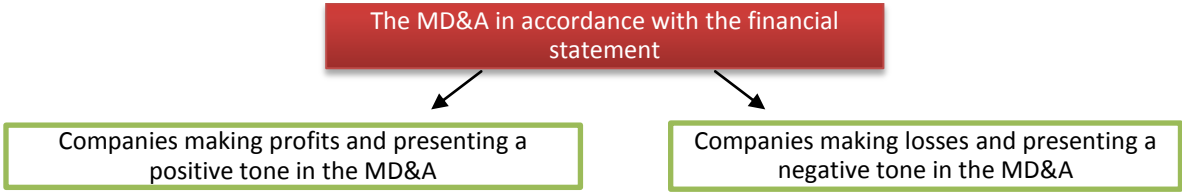

In the other category, five different groups could be found. The first two groups had a tone in the MD&A that was the opposite of the financial statement, in other words the company made a loss (profit) and the MD&A had an overall positive (negative) tone. The third group contained MD&As where the companies made losses and the net difference had a value of zero, meaning that an equal number of positive and negative sentences were found or a case where only neutral sentences were detected. The fourth group contained MD&As where the companies made profits and had once again an overall neutral tone in the MD&A. The last group consisted of MD&As of companies making either profits or losses and did not have any net difference because they did not give any information regarding the financial year. (Figure 3)

Figure 3. The second category, where the MD&As were not in accordance with the financial statement, with the belonging groups. (Davidsson & Hamrin, 2011)

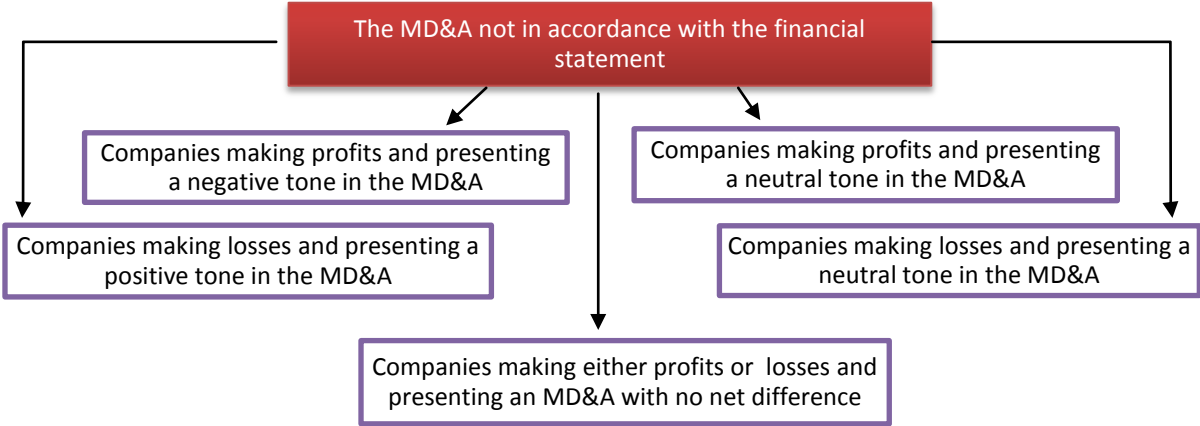

With this second part of the investigation made the result was divided into different groups depending on which variable was considered; *the net difference*, *the total amount of sentences*, *the financial result*, and a last group where the variables were combined. This division helped the authors to analyse the findings in different angles to finally, with the theoretical frame of reference in mind, be able to answer the second sub-question in the problem statement.

3.4.3 A content analysis of the MD&As with no accordance with the financial statement

The third and final part of the investigation was to do a deeper analysis of the MD&As that had no accordance with the financial statement, in other words an analysis of all the companies in the second category. The aim was to detect possible tendencies and reasons that could explain this lack of accordance between the two. To be able to reach an answer to the third sub-question in the problem statement the companies, categorized in the different groups, were further investigated. In every group, the authors analysed how many charged sentences were presented, and how strong the net difference was. In one of the groups, *Companies making profits and presenting a negative tone in the MD&A*, the type of information discussed in the relevant sentences was necessary to analyse to be able to understand if the management communicate in a way that was true to the financial statement. In order to discover tendencies and reasons for this lack of accordance between the MD&As and the financial statement, the empirical result was compared to the theoretical frame of reference.

3.5 Pilot study

A pilot study was made, where the MD&As of ten Swedish private unlimited companies were randomly selected and analysed. The aim of the study was, as mentioned, to follow the same principles applied in the entire investigation, and thereby detect pitfalls that could be corrected at an early stage of the investigation. The aim was also to get a sense of how much time the whole investigation would take and to see what type of result could be expected.

In these ten MD&As the total amount of sentences was counted to get a sense of how rich in information the MD&As were. The next step was to encode and count the amount of positive, negative, and neutral sentences, to be able to reach a final value of the MD&A. This net difference was calculated as the difference between the positive and negative sentences, while the neutral sentences were given the value zero. The final net difference, the tone of the MD&A, was compared to the profit or loss of the financial year. This line of action made it possible to see whether the MD&A gave the same information as the financial statement. Accordance between the two would suggest that the MD&A reflects the company in a true and fair view.

The result of the pilot study (table 1) was that the investigated companies' MD&As tended to be reflected in different ways. Four of the ten companies had a tone in the MD&A that was in accordance with the financial statement, suggesting that the management tend to communicate in a trustworthy way and that investigations made by Yuthas, Rogers, and Dillard (2002), Suchman (1995), Skinner (1994), and Abrahamson and Amir (1996) will be applicable. However, the majority, six companies, had a tone in the MD&A that was not in accordance with the financial statement, suggesting that the management do not give the same information in this narrative part as the financial statement does. Three of these companies made profits in the financial year of 2009 and had a net difference with the value of zero or no net difference. This finding suggests that the empirical investigation of Aerts (2001) among

others, seem to be applicable in this investigation. The final two companies were located in the second category, in the first and second group. One of the MD&As had a positive tone and presented a loss during the financial year, while the other one had the opposite situation. The first finding suggests that the management seem to embellish the information given, which may be an indication that the Pollyanna hypothesis is represented in the investigation. The second finding can be more difficult to explain due to the fact that hardly any theory discusses this situation. However, the investigation showed that the MD&A that was presented in a negative tone and where the company made a profit, only presented one sentence that happened to be negative, resulting in a negative tone in the MD&A. This may be slightly misleading, suggesting that a deeper analysis ought to be made to be able to reach a correct conclusion.

The pilot study indicated that the majority of the MD&As were not in accordance with the financial statement and that the communication used was reflected in different ways. This suggests that an investigation ought to be made to reach a final result of whether the management of Swedish private unlimited companies communicate in a way that is true to the financial statement.

Table 1. The result of the ten companies used in the pilot study. (Davidsson & Hamrin, 2011)

Company	Total amount of sentences in the MD&A	Positive sentences	Negative sentences	Neutral sentences	Net	Profit and loss for the year (SEK thousand)	Equity	(Profit or loss)/ (Shareholders' equity)
Vällinge Flooring Techlogy AB	88	8	4		4	35755	193507	0,1848
Nordic Light Aktiebolag	33	4	2	1	2	32653,96	114778,1	0,2845
Acne Studios AB	9	2	1	1	1	12253,36	32732,28	0,3744
Mediacommunications Services Sverige AB	12	2	1		1	-85,916	10795,18	-0,0080
Besqab Projektutveckling Aktiebolag	17			1	0	3396	12707	0,2673
Emballator Ulricehamns Bleck Aktiebolag	29			1	0	4311	183625	0,0235
Furninova Aktiebolag	29		1		-1	36621,12	45392,88	0,8068

Icopal Aktiebolag	26		1	2	-1	20455	131579	0,1555
AB Karlbergs Bilaffär	13	1	4	2	-3	-192	18938	-0,0101
Daloc AB	12					34151	127298	0,2683

3.6 The quality of the methodology

A content analysis as the mode of procedure has been used frequently in previous empirical investigations, such as the one made by Hildebrandt and Snyder (1981), Rogers and Grant (1997), Abrahamson and Amir (1996), Deegan and Rankin (1996), and Rutherford (2005). Even though the method has been used with success in empirical investigations doing textual analyses, challenges exist. The coding scheme may have a tendency to control the findings and turn one's attention to specific objects, making it hard to be open and objective to the material. To solve this problem, a way is to acquire a good understanding of the content of the material and start by reading parts of the material (Bergström & Boréus, 2005), something that was done in this investigation.

A content analysis focuses on quantifying certain objects in a text and this leads to the conclusion that the objects with the highest frequency are the most important ones, which in some cases may be misleading (Bergström & Boréus, 2005). "In many contexts the most important thing is not *how many times* something is being said but rather *how* something is said" (Bergström & Boréus, 2005; p.77) This may be seen as a criticism towards the methodology used in this investigation. The fact that a content analysis focuses on the statements being said and not on the things being unspoken can also be seen as a limitation. To reach reliability in the investigation it is of high importance that the unspoken will be taken into account. (Bergström & Boréus, 2005) To be able to fulfil this, the encoding of the material was made manually in such a way that no sentences slipped away. However, a manual encoding will always to some extent depend on subjectivity due to the fact that there are human beings doing the encoding. The authors are aware of the increased risk that it may be difficult for other researchers to do the same investigation and reach the same result. In that sense the use of a computer program leads to a more objective encoding, which decreases the risk of subjective judgements. However, due to the importance of finding the overall tone in the whole sentence and with the aim of doing a more complex judgement within the investigation, a manual encoding was to be preferred.

3.6.1 Validity

Investigations tend to reflect the reality in an accurate way when the measure of validity is high, which means that what is aimed to be measured is measured correctly. (Weber, 1990) When analysing a text, as in this investigation, it is of importance to reflect the whole sentence, in order to keep the context. This leads to a more valid result where the reality is reflected in an accurate way through the investigation. When focusing on simple words, like when the investigation is based on a list of keywords, mistakes can easily be made due to the

fact that the word is taken out of its context. By doing the investigation manually and taking the whole sentence into account, a higher validity can be achieved. However, Bergström and Boréus (2005) argue that texts always will be taken out of their context to some extent. All written texts are connected to the society and the language used in that specific time. As a result, the investigation made on 152 MD&As of the financial year of 2009 can be hard to repeat in the future since the society and language used in that time may be different. Regarding the size of the sample investigated, the question is whether the sample is large enough to be able to draw a conclusion of the whole population.

3.6.2 Reliability

By doing a content analysis the reliability, a measurement of consistency, may be affected. (Weber, 1990) Since the investigation was made manually, it resulted in a more subjective judgement depending on which person was encoding the material. Even though lists of keywords were being used, the consistency may be questioned since a high involvement of personal judgement existed (Weber, 1990). If a textual-analysis software had been used instead, the risk of subjectivity could be reduced, giving the result more stability and thereby a higher reliability. In order to strengthen the reliability in the investigation, thereby reducing the risk of subjectivity, the sentence had to meet certain criteria in order to be categorized as relevant. In case of disagreements the coders came to an agreement by discussing the sentence. However, this solution, aiming to decrease the risk of subjectivity, is not as good as it seems. The final coding may in this case be a result of the opinion of the person winning the discussion of the disagreement. Many investigations fail in reliability when encoding the material (Weber, 1990), which was taken into account before doing a content analysis.

Chapter 4

Empirical investigation

This chapter declares the empirical material from the content analyses of the MD&As in the investigation. The result is presented in three different parts, which consider the three sub-questions in the problem statement.

4.1 Result of the techniques used in the communication process

In some of the 152 MD&As investigated, the management used vague words when communicating negative information. The management of the company *Luvata Söderköping AB* presented the following sentences: “Luvata Söderköping has had a slightly weaker growth on the market during the financial year”, “The instability that occurred on the market in the year 2008 still remains in the year 2009 and has a high effect on the prices of raw materials and products...” and “As a consequence of the financial crisis, the demand has been slightly weak” (Luvata Söderköping AB, 2009; p.2). *Luvata Söderköping AB* made a loss of 867 per cent of shareholders’ equity in the financial year of 2009. The Management in companies such as *Tågia Aktiebolag* seemed to use a more objective way of communicating their negative information. For example, “The revenues of the financial year amount to 569.2 MSEK (654.9 MSEK)” (Tågia Aktiebolag, 2009; p.2). Another example is the MD&A of the company *EFG European Furniture Group Aktiebolag*: “The company’s net sales have decreased by 21.5 % to 550 (701) MSEK. The business result was -43 (27) MSEK” (EFG European Furniture Group Aktiebolag, 2009; p.2).

In many of the MD&As investigated a tendency to focus on the positive rather than the negative events, can be found. For example, *Aktiebolaget STOKAB* made a loss but the MD&A was reflected in a positive way and did not disclose any negative information. One example of a positive sentence is: “The level of orders received and the amount of delivered obligations are on a high level and on a level with the expected development” (Aktiebolaget STOKAB, 2009; p.2).

A tendency to use business communication can be found in many of the investigated MD&As. The management of the company *Aktiebolaget Berner & Co* stated that: “The company is in fact presenting a deficit but it is on a level with the budget” (Aktiebolaget Berner & Co, 2009; p.2). Another example of business communication is the charts used in almost every MD&A of the Swedish private unlimited companies investigated. *MVB Syd AB*, *ABT Bolagen AB*, *SP Fönster AB*, *Peak Performance Production AB* and *Östgöta Media AB*, chose to include charts presenting the economic overview of the company (table 2). The majority of the charts included a historical summary. However, a few MD&As such as that of *Östgöta Media AB* consisted of a chart only reflecting the financial year of 2009 (table 3).

Table 2. Economic overview of the company Icopal Aktiebolag (Icopal Aktiebolag, 2009; p.2)

Ekonomisk översikt (MSEK)	2009	2008	2007	2006	2005
Nettoomsättning (mkr)	501,6	610,9	569,9	488,3	461,8
Rörelseresultat (mkr)	18,6	15,0	19,1	15,7	9,9
Balansomslutning (mkr)	350,0	334,4	351,3	283,2	261,8
Soliditet, %	43,4	46,3	45,5	46,9	46,5
Antal anställda	110	131	133	135	143

Table 3. Economic overview of the company Östgöta Media AB (Östgöta Media AB, 2009; p.2)

Resultat och ställning

Översikt bolaget (Tkr)	2009
Nettoomsättning	538 294
Resultat efter finansiella poster	-32 847
Rörelsemarginal	Neg
Balansomslutning	153 801
Soliditet	16%

Some MD&As were not that clearly communicated. For example, in the MD&A of the loss-making company *TekinkMagasinet Sweden Aktiebolag* the management seemed to prefer to talk about events affecting the company in positive ways or events with no effect on the financial result whatsoever. Another example is the MD&A of the profit-making company *ABT Bolagen AB*, which did not present any information concerning the financial year of 2009. In contrast, other MD&As were communicated clearly, but the management tended to blame failures on other parties than the company. The MD&A of *AB Karlbergs Bilaffär* presented the following sentence: “The recession is the reason for the decline” (AB Karlbergs Bilaffär, 2009; p.2).

4.2 Result of the tone used in the communication process

4.2.1 The variable net difference (positive, negative, zero and non-existing)

A table presenting the total result of the investigation can be seen in the Appendix (A.1. Appendix). Of the 152 Swedish private unlimited companies that were analysed in this investigation, 63 companies (41 per cent) presented the MD&A with a positive tone, while 41 of the selected companies (27 per cent) presented an overall negative tone. 28 companies (18 per cent) had a net difference of zero, indicating that these companies presented both positive and negative information to the extent that the net difference obtained a value of zero or that the companies only had neutral sentences. 20 companies (13 per cent) had no net difference, which means that these companies do not present any information about the financial year. (Table 4)

Table 4. The number of MD&As with a positive, negative, and neutral tone, as well as the amount of MD&As with no net difference. (Davidsson & Hamrin, 2011)

	Positive tone in the MD&A	Negative tone in the MD&A	Neutral tone in the MD&A	No net difference; not presenting any information about the financial year
Amount of MD&As (numbers)	63	41	28	20
Amount of MD&As (%)	41	27	18	13

The highest net difference found in the investigation was +12. In total, eight companies had a net difference higher than (\geq) +5. (Table 5) The lowest net difference was -4 and a total of nine companies had a net difference lower than (\leq) -3. (Table 6) The remaining 115 companies with a net difference, had a value between +4 and -2³. There were 13 companies with a net difference of +2, 35 companies with a net difference of +1, 28 companies with a net difference of 0, 25 companies with a net difference of -1, and seven companies with a net difference of -2. This indicates that the most common net difference, the mode, was +1 closely followed by 0.

Table 5. The companies with the highest net difference. (Davidsson & Hamrin, 2011)

Company	Total amount of sentences in the MD&A	Positive sentences	Negative sentences	Neutral sentences	Net	Profit and loss for the year (SEK thousand)	Equity	(Profit or loss)/ (Shareholders' equity)
UNIT4 Agresso AB	71	15	3	18	12	35182	78271	0,4495
Jacobi Carbons AB	44	11		10	11	6758	50525	0,1338
Proact IT Sweden AB	42	9	2	6	7	20467	42760	0,4786
Aktiebolaget Sollentunahem	52	11	4	16	7	146067	996648	0,1466
Länsförsäkringar Fondförvaltning Aktiebolag	44	8	1	4	7	36901	73460	0,5023
Aktiebolaget STOKAB	36	6		3	6	-11151	173033	-0,0644
Happy Homes Sverige AB	10	6		1	6	1401,584	16016,9	0,0875
Svenska Lantägg Aktiebolag	84	12	7	11	5	1030,274	23171,1	0,0445

³ +4 \leq Net difference \geq -2

Table 6. The companies with the lowest net difference. (Davidsson & Hamrin, 2011)

Company	Total amount of sentences in the MD&A	Positive sentences	Negative sentences	Neutral sentences	Net	Profit and loss for the year (SEK thousand)	Equity	(Profit or loss)/ (Shareholders' equity)
Laird Technologies AB	16		4	3	-4	-3465	240963	-0,0144
Luvata Söderköping AB	17		4		-4	-25171,454	2903,537	-8,6692
InfoCare Service AB	46	2	6	4	-4	21744	17308	1,2563
Rörvik Skog AB	54	2	5	6	-3	-6630	45144	-0,1469
Tågäa Aktiebolag	20	1	4	7	-3	-3957	3732	-1,060
EFG European Furniture Group Aktiebolag	28		3	9	-3	-83864	232173	-0,3612
Nimbus Boats Holding AB	34	1	4	2	-3	-49460	374827	-0,1320
Dagens Industri Aktiebolag	14	0	3	1	-3	54379	16333	3,3294
AB Karlbergs Bilaffär	13	1	4	2	-3	-192	18938	-0,0101

4.2.2 The variable total amount of sentences

The total number of sentences in the MD&As was 3200 and the total number of sentences discussing the financial result of the year was 818. Of these 818 sentences, 276 (34 per cent) were positively charged, 199 (24 per cent) were of a negative nature and 343 (42 per cent) were neutral sentences. The average length of the MD&A was 21 sentences, while the median was 18 sentences. (Table 7) However, the length of the MD&A differed between 3 and 88 sentences. As seen in table 5, the companies with the highest net difference had a relatively long MD&A. The mode, regarding the length of the MD&A was 14 sentences. Furthermore, eight companies had an MD&A with the length of 12 sentences and another group of eight companies had an MD&A with the length of 9 sentences.

Table 7. The amount, the average, and the median of sentences. (Davidsson & Hamrin, 2011)

	Positive sentences	Negative sentences	Neutral sentences	Total amount of sentences in the MD&A regarding the financial year	Total amount of sentences in the MD&A
Amount of sentences (numbers)	276	199	343	818	3200
Amount of sentences (per cent)	33,7	24,3	41,9	1	1
Average amount of sentences (numbers)					21
Median (numbers)					18

4.2.3 The variable financial result (profit or loss)

Of the data analysed 118 companies (78 per cent) made a profit and 34 (22 per cent) made a loss.

4.2.4 The collaboration of the variables

With the variables *net difference* and *financial result* in mind, the overall tone in the MD&A was in accordance with the financial statement in 79 companies (52 per cent), where 58 (38 per cent) made a profit and had a positive tone and 21 companies (14 per cent) made a loss and had an MD&A with a negative tone. (Figure 4) 73 companies (48 per cent) had a tone in the MD&A that was not in accordance with the financial statement, suggesting that these companies do not give the same information in the MD&A as in the financial statement. As mentioned in the methodology, the MD&As that were not in accordance with the financial statement were categorized into five different groups, depending on how the information was presented. (Figure 5)

Figure 4. The number of MD&As in accordance with the financial statement, making either losses or profits. (Davidsson & Hamrin, 2011)

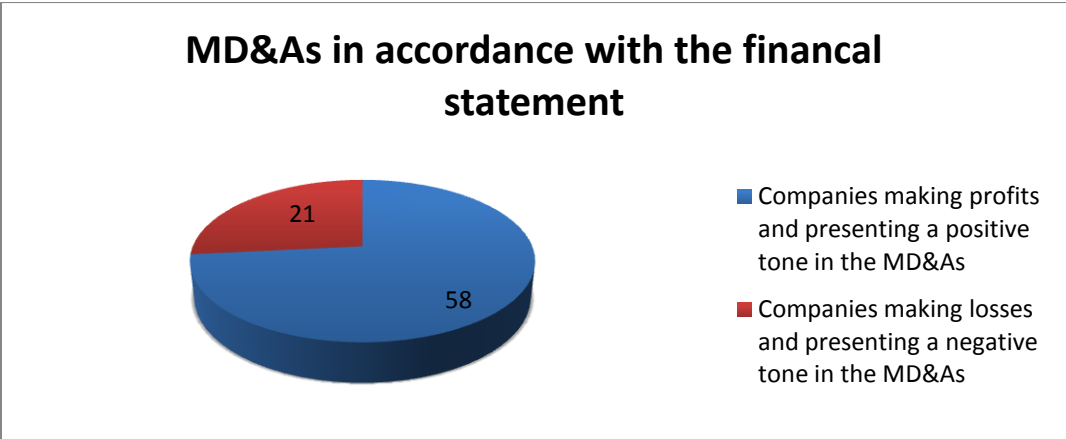
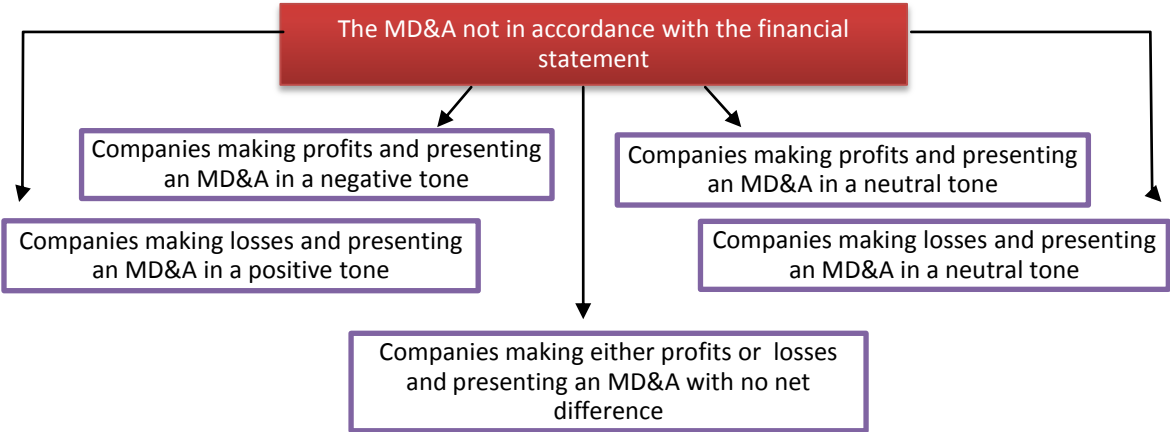
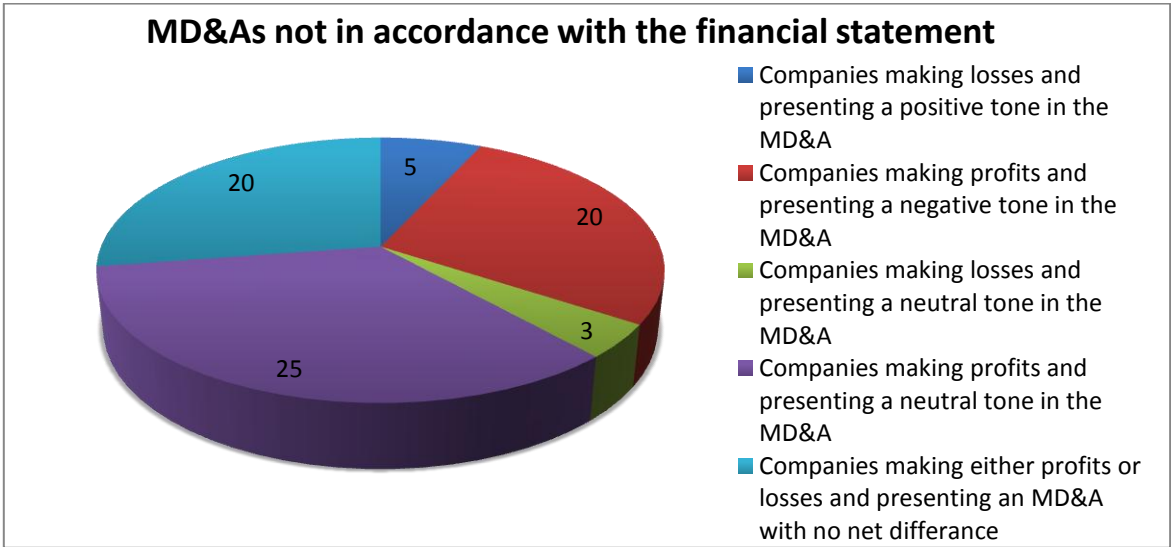

Figure 5. The second category, where the MD&As were not in accordance with the financial statement, with the belonging groups. (Davidsson & Hamrin, 2011)



The first group, five of the 73 companies (7 per cent) made losses in the financial year of 2009 and presented a positive tone in the MD&A, while the second group consisted of 20 companies (27 per cent) that in contrast made profits and had a negative tone. The third group, three of the 73 companies (4 per cent) made losses and presented either both positive and negative information to the extent that it resulted in a net difference with the value zero or only presented neutral sentences. 25 companies, representing the fourth group (34 per cent) made profits and had a net difference of zero, a neutral tone in the MD&A. In the third and fourth group 25 of the total 28 companies presented the information in the MD&A in a neutral tone or had simply a few positive and negative sentences. Of these 25 companies, 23 made a profit and several presented a result higher than 50 per cent of shareholders’ equity. Three of the 28 companies did to a greater extent present both positive and negative information. The last group, 20 companies (27 per cent), had no net difference and thereby gave no information about the financial year of 2009. In this group the majority, 15 companies, made a profit and five companies made a loss. (Figure 6)

Figure 6. The number of MD&As not in accordance with the financial statement, in the five different groups. (Davidsson & Hamrin, 2011)



4.3 Result of the MD&As not in accordance with the financial statement

In this part of the result of the empirical investigation the authors will analyse the five different groups of the MD&As that are not in accordance with the financial statement. Tables will be presented, reflecting some of the MD&As worth analysing further for different reasons making them interesting in comparison to the others.

4.3.1 Companies making losses and presenting a positive tone in the MD&A

In this group five companies can be found, they made a loss and presented an MD&A in an overall positive tone. One company did not use any negative sentences, resulting in a positive tone in the MD&A (the net difference was +6). The remaining four companies gave positive, negative, and neutral information, in other words the MD&As consisted of positive, negative, and neutral sentences. Two of the five companies had more neutral sentences than negative or positive ones. (Table 8)

Table 8. Three of the companies making losses and presenting a positive tone in the MD&A. (Davidsson & Hamrin, 2011)

Company	Total amount of sentences in the MD&A	Positive sentences	Negative sentences	Neutral sentences	Net	Profit and loss for the year (SEK thousand)	Equity	(Profit or loss)/ (Shareholders' equity)
Aktiebolaget STOKAB	36	6		3	6	-11151	173033	-0,0644
Södra Interiör Aktiebolag	29	3	2	7	1	-8192	147885	-0,0554
TeknikMagasinet Sweden Aktiebolag	21	2	1	6	1	-2726,976	75968,39	-0,0359

4.3.2 Companies making profits and presenting a negative tone in the MD&A

This group consists of 20 companies that made profits in the financial year of 2009 and had MD&As in an overall negative tone. The MD&As had in total 27 positive, 57 negative, and 30 neutral sentences. The average net difference was -1.5 in this group, compared to the average net difference of all the 152 companies which was -1.68. 10 of the companies (50 per cent) presented positive, negative, and neutral sentences. 8 companies (40 per cent) did not present any positive sentences at all. Furthermore, 13 of the companies (65 per cent) presented a profit higher than 25 per cent of shareholders' equity. (Table 9)

Table 9. Two of the companies making profits and presenting a negative tone in the MD&A. (Davidsson & Hamrin, 2011)

Company	Total amount of sentences in the MD&A	Positive sentences	Negative sentences	Neutral sentences	Net	Profit and loss for the year (SEK thousand)	Equity	(Profit or loss)/ (Shareholders' equity)
Dagens Industri Aktiebolag	14		3	1	-3	54379	16333	3,3294
InfoCare Service AB	46	2	6	4	-4	21744	17308	1,2563

An overwhelming majority of the companies in this group, claimed to be affected by the recession. Almost every negative sentence found, discussed how the recession affected the company's activity and development. Typical sentences were for example: "The financial crises also affected the glue-industry and the company lost volume" (Henkel Adhesive Technologies Norden Aktiebolag, 2009; p.2) "The global state of the market and the air service was heavily reduced" (A-Train Aktiebolag, 2009; p.3), and "The weakness of the public economy has drastically affected the sales of advertisement...also the sales of edition were affected by the recession" (Dagens Industri Aktiebolag, 2009; p.1).

4.3.3 Companies making losses and presenting a neutral tone in the MD&A

This group consists of three companies that made a loss in the financial year of 2009 and had an overall neutral tone in the MD&A. The MD&As of these companies had an average length of 13 sentences. Two of the companies gave positive, negative, and neutral information and declared a loss greater than ten per cent of shareholders' equity. The third company only presented neutral sentences and declared a loss of 94 per cent of shareholders' equity. (Table 10)

Table 10. One of the companies making losses and presenting a neutral tone in the MD&A. (Davidsson & Hamrin, 2011)

Company	Total amount of sentences in the MD&A	Positive sentences	Negative sentences	Neutral sentences	Net	Profit and loss for the year (SEK thousand)	Equity	(Profit or loss)/ (Shareholders' equity)
New Wave Sports AB	9			2	0	-6322	6745	-0,9373

4.3.4 Companies making profits and presenting a neutral tone in the MD&A

In this group 25 companies can be found, they made a profit and had an MD&A with an overall neutral tone. 15 of these 25 companies (60 per cent) had an MD&A that presented only neutral sentences, however, out of these 15 MD&As 13 contained two neutral sentences at most. (Table 11)

Table 11. Two of the companies making profits and presenting a neutral tone in the MD&A. (Davidsson & Hamrin, 2011)

Company	Total amount of sentences in the MD&A	Positive sentences	Negative sentences	Neutral sentences	Net	Profit and loss for the year (SEK thousand)	Equity	(Profit or loss)/ (Shareholders' equity)
Peak Performance Production AB	9			1	0	114663	34438	3,3295
Mjögäcks Entreprenad Aktiebolag	26	3	3	2	0	5727,558	198130	0,0289

4.3.5 Companies making either profits or losses and presenting an MD&A with no net difference

This group consists of 20 companies, where 15 made a profit and five made a loss. These companies had an MD&A with an average length of 7.75 sentences and the median was 5.5 sentences. Twelve of the companies that made a profit (60 per cent) declared a financial result greater than 24 per cent of shareholders' equity. More than half of the companies that made a loss presented a financial result that was less than 2.5 per cent of shareholders' equity. (Table 12)

Table 12. Two of the companies making (either profits or) losses and presenting an MD&A with no net difference. (Davidsson & Hamrin, 2011)

Company	Total amount of sentences in the MD&A	Positive sentences	Negative sentences	Neutral sentences	Net	Profit and loss for the year (SEK thousand)	Equity	(Profit or loss)/ (Shareholders' equity)
SP Fönster AB	5					-8457	272	-31,0919
Östgöta Media AB	4					-30362	18482	-1,6428

Chapter 5

Analysis

The empirical findings are in this chapter compared with the Theoretical Frame of Reference. This chapter consists of three parts, representing the three sub-questions from the problem statement. The analysis made in this chapter works as the base of the conclusions drawn in the chapter that follows.

5.1 Analysis of the techniques used in the communication process

When the information is transformed into a message the sender, in other words the management, chooses what message to communicate and how to communicate it (Clampitt, 2005; Shannon, 2001). This may have an impact on the final message received by the reader of the MD&A and an example of this is a sentence stated in the MD&A of the company *Luvata Söderköping AB*: “Luvata Söderköping had a slightly weaker growth on the market during the financial year” (Luvata Söderköping AB, 2009; p.2). This sentence shows that the company has had a bad year, but uses a type of communication that is not as powerful as it could be, suggesting that the intended meaning depends on which technique is being used in the communication process (Katz, 2001).

A use of passive words is desirable when the writer wants to distance him or herself from the information given (Thomas, 1997). In the MD&A of *EFG European Furniture Group Aktiebolag* this tendency can be found. The management states that: “The company’s net sales have decreased by 21.5 % to 550 (701) MSEK. The business result was -43 (27) MSEK” (EFG European Furniture Group Aktiebolag, 2009; p.2), an indication of the fact that the management only wants to state the fact and then distance themselves from the message (Thomas, 1997). The same tendency can be found in the MD&A of *Tågia Aktiebolag* where the management states that the revenues for the financial year amount to 569.2 MSEK and that last year’s revenues were 654.9. In this case the management uses a relational process verb avoiding telling that the revenues have decreased. This technique gives the message a more objective tone and can be used with success when the writer once again only wants to state the fact and then distance him or herself from it. (Thomas, 1997)

When writing the MD&A the management may use a manipulative language with the aim of misleading the reader’s understanding of the company’s performance (Bedford & Baladouni, 1962), this tendency can be found in the MD&A of *Aktiebolaget STOKAB*. The management chose to write about good things that have happened instead of focusing on the financial year characterized by a loss. This tendency may be found in many of the MD&As investigated and is a result of the fact that the cost is less than the benefits associated with a positive disclosure. (Bettman & Weitz, 1983; Clarkson, 1994) Another example where a manipulative language can be found is in the MD&A of *Luvata Söderköping AB*, where the management states that: “As a consequence of the financial crisis, the demand has been slightly weak” (Luvata Söderköping AB, 2009; p.2). In this sentence the management uses the word “slightly”, a

vague type of word, when the company in fact made a loss of 867 per cent of shareholders' equity in the financial year of 2009.

It is argued that the communicator has a rhetorical choice in how to express the message, thereby the intended meaning can be translated into a different one depending on which technique is used in the communication process. (Katz, 2001) An example of this is a sentence in the MD&A of the company *Aktiebolaget Berner & Co*: "The company is in fact presenting a deficit but it is on a level with the budget" (*Aktiebolaget Berner & Co*, 2009; p.2). In this sentence the management choose to use the word deficit instead of loss, which may be a more difficult word for readers not familiar with the business language. The management also claim that the "deficit is on a level with budget", which may make it difficult to understand whether the meaning is positive or negative. This may be connected to the theory of Rogers and Stocken (2005). The theory declares that the message to some extent depends on which type of language the communicator uses, but also that the comprehension of the received message depends on the capability of the receiver and his or her overall equipment.

Another example of the importance of understanding business language, to fully comprehend the message, is when the MD&A do not present much information about the financial year except a chart presenting an economic overview. These charts, found in almost every company such as *MVB Syd AB*, *ABT Bolagen AB*, *SP Fönster AB*, and *Östgöta Media AB*, are rich in information, but require that the reader has business knowledge. The MD&A of *Östgöta Media AB* consists of a chart that only reflects the financial year of 2009. This chart does not help the understanding of the company due to the fact that the reader can not compare the information given with previous financial years. The understanding of the content of a written sentence is to a high degree dependent on whether the reader understands the language but also if the reader has access to the sentence's source. (Rogers & Stocken, 2005) The reader might have to read between the lines when the information in a message is not clearly communicated (Shannon, 2001). This can be found in the MD&A of *Östgöta Media AB*, where the reader might have to compare this year's financial information with either a competitor's information or with the annual report from last year, to fully understand the company's development.

The company *TeknikMagasinet Sweden Aktiebolag* made a loss in the financial year of 2009. The communication in the MD&A is a bit diffuse, consisting of information with different insinuations. This communication suggests that the company does not want to present too much information about the financial year that revolves around a loss. This tendency may be presented in MD&As of companies making losses, due to the negative effect this type of information has on stock prices (Hutton; Miller & Skinner, 2003; Skinner, 1994; Kaznik, 1999) or as in this case, the negative affect it may have on the reader's perception of the company. The charts used for example in the MD&A of *Peak Performance Production AB*, supplement the positive information given about the financial year. This chart functions as verification to the information given in the MD&A and is necessary to be able to get a positive effect on stock prices (Hutton; Miller & Skinner, 2003) or such in this case, to get the

reader to trust the information given. These findings exist due to the fact that bad news tends to be more trustworthy than good news. Thereby, bad news does not need verification in the same way as good news does. (Hutton; Miller & Skinner, 2003; Roger & Stocken, 2005)

Aktiebolaget STOKAB made a loss in the financial year of 2009, but the MD&A did not include negative information. The management's choice not to disclose negative information may be a result of the importance of attracting new financiers (Clarkson; Kao & Richardson, 1994). In the MD&A of the profit-making company *ABT Bolagen AB*, no information could be found discussing the financial year, which indicates that the company withheld information. Even though the company made a profit, the MD&A did not reflect the company in a positive way which might be the case due to the high concentration of competitors (Clarkson; Kao & Richardson, 1994). However, this absence of information may affect the company negatively due to the fact that the reader may question the credibility of the rest of the information in the annual report (Davis et al., 2006; Deegan & Rankin, 1996).

According to a sentence given in the result of the empirical investigation, the management of *Luvata Söderköping AB* has a tendency to blame the negative result on the financial crises, which may have a connection with different theories saying that managers have a tendency to blame failures on the external environment (Bettman & Weitz, 1983; Salancik & Meindl, 1984; Staw et al., 1983; Thomas, 1997). In a sentence in the MD&A of *AB Karlbergs Bilaffärer*; "The recession is the reason for the decline" (AB Karlbergs Bilaffärer, 2009; p.2), a tendency to claim that the failures are beyond the management's responsibility can be found (Thomas, 1997).

An information gap exists between insiders and outsiders of the company and can be spotted in the MD&A of *Aktiebolaget STOKAB*. The fact that this MD&A was reflected in a positive way may influence the reader's perception of the company's economic conditions (Lev, 1992) However, Rutherford (2005) questions the sender's ability to fool the reader, due to the fact that the reader is often educated within the subject.

5.2 Analysis of the tone used in the communication process

5.2.1 The variable net difference (positive, negative, zero and non-existing)

The investigation of 152 MD&As of Swedish private unlimited companies showed that companies tended to reflect the information in different ways (positive, negative, neutral way or not presenting any information at all). The largest part, 63 companies or 41 per cent, had a positive tone when describing the financial year of 2009. This may not come as a surprise, investigations made by Bocher and Osgood (1969), Hildebrandt and Snyder (1981), and Postman (1958) indicated that companies tend to use positive words with a higher frequency than negative ones, regardless of the companies' financial result. The investigation does thereby support this theory and suggests that companies tend to be more optimistic, like the Pollyanna hypothesis states. More recent studies from Rutherford (2005) showed that companies to a great extent filled their Operating and Financial Review (OFR) with positive

words and “up”-words, for example “increase”. This can also be found in our investigation and due to the fact that the whole sentence was analyzed this is not a result of a continuous rise of price levels or other misleading factors that Rutherford (2005) mentioned, suggesting that the Pollyanna hypothesis may be spotted.

However, the fact that only eight out of 152 companies had a net difference higher than (\geq) +5 (table 5), suggests that the Pollyanna hypothesis is not very rife among Swedish private unlimited companies. The fact that the most common net difference was as low as +1 and 0, strengthens this theory. As mentioned in the result of the empirical investigation there were nine companies with a net difference lower than (\leq) -3 (table 6), suggesting that companies present negative information as well. This tendency can be connected to the investigations made by Pava and Epstein (1993), Rutherford (2005), and Yuthas, Rogers, and Dillard (2002). The authors claimed that companies overall present both positive and negative information, being more honest about the performance during the financial year.

5.2.2 The variable total amount of sentences

In the result of the empirical investigation, 42 per cent of the sentences that discussed the result of the financial year of 2009 were categorized as neutral sentences. This finding suggests that companies tend to present unchanged or stable information in the MD&A (Aetrs, 2001; Clarkson; Kao & Richardson, 1994). This may also indicate that companies choose to follow the recommendations, stating that the MD&A ought to be neutral, not being too positive nor too negative (Pava & Epstein, 1993). However, the fact that the number of negative sentences is almost as large as the amount of positive sentences, signals that companies in general tend to voluntarily give both positive and negative information in the MD&A (Skinner, 1994).

As mentioned, the average length of the MD&A is 21 sentences and the median is 18 sentences. The mode is 14 sentences which can be found in nine of the companies, thereafter eight companies had an MD&A with the length of 12 sentences and another group of eight companies had a length of 9 sentences. Furthermore, there are only 14 companies presenting more than 40 sentences in the MD&A. These assertions suggest that companies do not give much information, a tendency to withhold information. (Clarkson; Kao & Richardson, 1994).

5.2.3 The collaboration of the variables

With the variables *net difference* and *financial result* in mind, the majority of the companies investigated (52 per cent) presented an MD&A with a tone that was in accordance with the financial statement. This result indicates that the MD&A like the President’s Letter investigated by Abrahamson and Amir (1996) is correlated with the information given in the financial statement.

Of the 152 companies investigated, 34 presented a loss in the financial statement. Out of these companies almost 62 per cent presented their MD&A in a tone that was in accordance with the declared loss of the financial year of 2009. This statement suggests that investigations like

the one made by Yuthas, Rogers, and Dillard (2002) can be applied. According to the authors, companies regardless of whether they make a profit or a loss tended to a great extent to give both positive and negative information.

The fact that 78 per cent of the companies made a profit during the financial year of 2009 and only 41 per cent of all the companies investigated had a positive tone in the MD&A, indicates that companies do not present much positive information. This result in a tendency to doubt the Pollyanna hypothesis. However, this finding must be further analysed due to the fact that it may for example be a result of companies making a slight positive result and presenting information in a true and fair view (Yuthas; Rogers & Dillard, 2002).

There are as much as 48 per cent of the companies investigated that do not present the same information in the MD&A as given in the financial statement. The first group, seven per cent of the companies, were making a loss but chose to present the MD&A in a positive tone, which can be connected to the investigation made by Deegan and Rankin (1996). The authors focused on how companies chose to present environmental information. The investigation concluded that companies tend to disclose information that is positive and withhold negative information, aiming to present the company in a positive way. The fact that 18 per cent of the companies investigated had a net difference of zero and 25 of them presented hardly any positive or negative information at all, can be connected to the theory of Clarkson, Kao, and Richardson (1994). It is stated that companies making profits tend to decrease the information given in the presence of threats from competitors. This can be applied among the Swedish private unlimited companies due to the fact that 23 of the 25 companies with a neutral tone in the MD&A made a profit. 13 per cent of all the companies investigated had no net difference and several presented a result that was higher than 50 per cent of shareholders' equity. 27 per cent of the companies having an MD&A with a tone that was not in accordance with the financial statement, made a profit but had a negative tone in the MD&A. This finding can be difficult to connect to previous studies discussed in the theoretical frame of reference.

To conclude, a majority of 52 per cent of the investigated MD&As had a tone that was in accordance with the financial statement, suggesting that the management seems to communicate a tone in the MD&A that is true to the financial statement. However, the fact that 48 per cent of the MD&As had a tone that was not in accordance with the financial statement, indicates that it may be drastic to say that the management communicate the correct tone in the MD&A without doing a deeper analysis. (Figure 7)

Figure 7. The amount of MD&As (per cent) in accordance and not in accordance with the financial statement. (Davidsson & Hamrin, 2011)

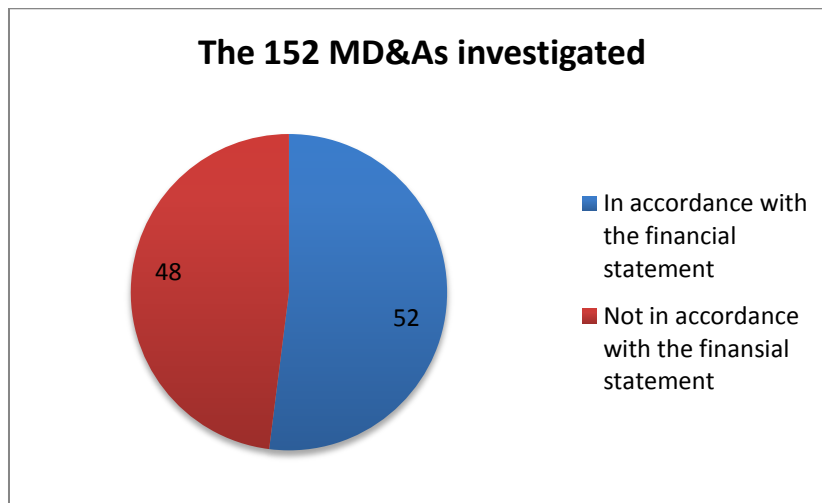

5.3 Analysis of the MD&As with no accordance with the financial statement

5.3.1 Companies making losses and presenting a positive tone in the MD&A

The fact that one out of the five companies, *Aktiebolaget STOKAB*, had a relatively high net difference, +6, and did not present any negative sentences, suggests that the Pollyanna hypothesis to a larger extent is presented within companies making losses (Rutherford, 2005). On the other hand, the remaining four companies presented both positive and negative sentences, which do not support the Pollyanna hypothesis. Instead this may be a sign that companies tend to present all information available due to the importance of legitimacy. This is also an effect of willingness to reach a high credibility among the readers. (Suchman, 1995; Yuthas; Rogers & Dillard, 2002)

The theory of Aerts (2001) may also be found to some extent in this group of companies, due to the fact that two of the five companies presented more neutral sentences than negative or positive ones. *TeknikMagasinet Sweden Aktiebolag* and *Södra Interiör Aktiebolag* presented six and seven neutral sentences respectively. (Table 8) This may be a result of that stability has become more important to investors, thereby resulting in an influence on managers' behaviour to present information with stability in the MD&A (Aerts, 2001).

5.3.2 Companies making profits and presenting a negative tone in the MD&A

The fact that these MD&As to 50 per cent consists of negative sentences regarding the financial year, can be difficult to understand and connect to the theory discussing the management's way of communicating. The MD&As had an average net difference of -1.5, which is lower than the average net difference of all the 152 companies investigated. This choice to decrease information, may be the case for these profit-making companies due to the presence of threats from competitors (Clarkson; Kao & Richardson, 1994)

Half of the MD&As communicated positive, negative, and neutral sentences, which can be connected to the investigation made by Yuthas, Rogers, and Dillard (2002). The authors stated that companies regardless of the result tended to communicate in a more truthful manner than companies that did not have any information to report. The MD&A of *InfoCare Service AB* presented all different types of information, which may be a result of the importance of truthfulness and a result of accountants and directors ability to influence the management to bring forth information (Abrahamson & Amir, 1996). Another reason for companies to disclose information, is that it will be to their favour in the long run because lack of disclosures may harm the trust of the shareholders (Yuthas; Rogers & Dillard, 2002).

However, 40 per cent of the companies in this group did not present any positive sentences, this is a bit strange due to the fact that a total of 65 per cent of these companies presented a profit higher than 25 per cent of shareholders' equity. For example, *Dagens Industri Aktiebolag* presented a profit of 333 per cent of shareholders' equity, but the MD&A reflected a negative tone with a net difference of -3. These findings seem to be a result of the management's discussion of the recession and the effect it had on the company, which resulted in a negative tone in these MD&As. The fact that charts were presented to a high degree in the MD&As, may be a way to compensate for the lack of information explaining the result of the financial year.

5.3.3 Companies making losses and presenting a neutral tone in the MD&A

This group of companies did not give much information, the average length of the MD&A was 13 sentences and they did not present many positive, negative, or neutral sentences either. One of the companies, *New Wave Sports AB*, only presented neutral sentences and made a loss of 94 per cent of the shareholders' equity. These findings may be connected to the investigation made by Clarkson, Kao, and Richardson (1994), where companies making losses tend to decrease the amount of forecast given when the interest of attracting financiers is high. Another reason for not giving too much information, is the companies' interest of keeping their stakeholders. However, some investigations declare that it is of importance to become consistent when disclosing information. A consistent behaviour will lead to higher reliability and create and maintain a good reputation. (Gibbins; Richardson & Waterhouse, 1990)

5.3.4 Companies making profits and presenting a neutral tone in the MD&A

Forecast information in companies making profits tend to decrease in the presence of threats from competitors (Clarkson; Kao & Richardson, 1994), which may explain why 60 per cent of the companies in this group only presented negative sentences in the MD&A. Another example is *Peak Performance Production AB*, which declared a profit of 333 per cent of shareholders' equity and only presented one sentence discussing the financial year. 13 of the companies had an MD&A consisting of two neutral sentences at the most, also suggesting that the management is avoiding presenting too much information. The tendency of being too neutral may have a negative effect on the company's market value, due to the fact that stakeholders translate non-disclosures as a sign that the companies do not present the whole

truth. (Lev & Penman, 1990) The fact that *Mjögäcks Entreprenad Aktiefbolag* presented positive, negative, and neutral sentences may be their way of avoiding being too neutral and losing shareholders' trust, which confirms the investigation made by Clatworthy and Jones (2001). The investigation stated that companies making losses preferred not to discuss the reasons for the bad result, instead they gave both positive and negative information.

5.3.5 Companies making either profits or losses and presenting an MD&A with no net difference

The fact that these MD&As had an average length of 7.75 sentences and a median of 5.5 sentences, can be seen as a sign of managers being ritualistic and giving the MD&As a stable and neutral tone (Aerts, 2001). However, this can not explain the fact that 60 per cent of the companies declare a financial result greater than 24 per cent of the shareholders' equity. This may be an indication that Swedish private unlimited companies do not present all information that has to be included according to law, suggesting that the result of the investigation made by Törning and Ericson (2006) is still valid. For example, two of the five companies with the lowest financial result, *SP Fönster AB* and *Östgöta Media AB*, presented no more than five and four sentences respectively in the MD&As, also suggesting that companies tend to avoid talking about bad happenings (Clarkson; Kao & Richardson, 1994). However, Cooke (1989) claimed that the amount of information disclosed depends on the company in question. The author stated that large listed companies ought to and did present more information than smaller unlisted companies, which may explain why many of these companies do not present much information. Another reason for the lack of information may be, as mentioned before, a result of the high amount of charts used in the MD&As, which aim to explain the financial result.

To conclude, the investigation of the 73 MD&As that are not in accordance with the financial statement, showed that despite having a net difference that differed from the financial result, the management seemed to present information reflecting the company in a true way. However, many of the MD&As did not present much information, giving it a more neutral and quiet tone.

Chapter 6

Conclusion

In this last chapter the aim is to discuss the analysis and conclude the result of the investigation, by answering the problem statement. A discussion regarding further research within the subject will end the chapter.

The purpose of this thesis was to investigate the MD&As of Swedish private unlimited companies to see whether the management communicate in a way that is true to the financial statement. The aim was to discover which techniques were used, and if the MD&As presented the company in a tone that was in accordance with the financial statement. In case of no accordance between the two, the aim was also to do a further investigation to see if any tendencies or reasons could be found explaining this lack of accordance.

As previous chapters, this chapter will also be divided into three parts discussing the three sub-questions to be able to answer the problem statement in a forth part.

6.1 The techniques used in the communication process

The first sub-question in the problem statement: *Which techniques are used in the communication process?* aimed to be answered in this part of the conclusion.

The management uses different techniques when communicating in the MD&A. Tendencies can be found indicating that the management use these techniques to embellish the information discussing the financial year. A usage of passive words and relational process verbs when disclosing negative information helps the management to distance themselves from the message. Another technique, discussed in the theoretical frame of reference and in this investigation was a usage of vague words to embellish the information concerning bad performance during the financial year. Some MD&As used more business language and charts expressing the financial development, which may be difficult for “amateur” readers to understand. In other situations, where the management could not escape discussing information, a tendency to blame failures on the external environment could be found.

Due to the fact that the management according to law and praxis has to discuss certain subjects in the MD&A, these techniques seemed to be used anyway to reflect the company in a positive tone. The desire to reflect the company in a positive way may be a result of the fact that negative information tends to lead to negative effects, such as the reader’s perception of the company being damaged which may lead to a loss of financiers. There are some investigations discussing the fact that the readers of the annual report and the MD&A ought to understand that the management tend to reflect the company in a somewhat embellished way.

If this is true, the readers, with this in mind, ought to get accurate information in the MD&A about the company's performance.

6.2 The tone used in the communication process

The second sub-question in the problem statement: *How is the overall tone in the MD&A in comparison to the financial statement?* aimed to be answered in this second part of the conclusion.

Discovered in this second part of the investigation was that depending on which type of information was considered within the variable, different answers could be found to this question. It seemed like every theory discussed in the theoretical frame of reference could be applicable. With the variable *net difference* in mind, the most common was +1 followed by 0, which suggests that the MD&As are reflected in a positive or neutral way. This may be seen as an indication of the management avoiding presenting too much information. Taking the variable *total amount of sentences* into consideration, an indication of presenting stable and unchanged information in the MD&A was found. The fact that the average, the median, and the mode regarding *total amount of sentences* were relatively low, strengthened the theory that the management tended to avoid giving too much information. However, the fact that the amount of negative sentences was almost as large as the amount of positive sentences, gave a signal that the management in general tended to voluntarily give both positive and negative information. This finding suggests that the MD&As are reflected honestly and that all information about the performance during the financial year is disclosed.

With all the variables taken into account a clearer pattern could be detected. With the variables *net difference* and *financial result* in consideration, 52 per cent of the MD&As were presented in a tone that was in accordance with the financial statement. Even for the loss-making companies a majority of 62 per cent of the MD&As were reflected in a truthful way. However, the fact that 48 per cent of the MD&As investigated had a tone that was not in accordance with the financial statement and that, how these MD&As were presented varied to a high degree, suggested that a deeper analysis had to be made.

6.3 The MD&As that are not in accordance with the financial statement

The third sub-question in the problem statement: *In case of no accordance between the MD&A and the financial statement, how is the information presented in the MD&As and is it possible to see any tendencies or reasons explaining the lack of accordance?* aimed to be answered in this final part of the conclusion.

The findings in this part of the investigation, suggested that these MD&As despite of having a net difference with no accordance with the financial statement, to a high degree presented both positive and negative information. This indicates a willingness of the management to discuss all the significant events that happened during the financial year. Almost every

MD&A with a negative tone, presented sentences discussing the recession, wherefore a negative net difference appeared, which also indicated a tendency to present all the significant events effecting the company. However, many of the MD&As did not give much information, suggesting that the management seemed to tell the truth but try to avoid giving too much information. This finding may be a result of the fact that charts discussing the financial year were presented, instead of words explaining it.

6.4 Does the management communicate in a way that is true to the financial statement?

The management seems to use techniques in the communication process that embellish the truth slightly. After all, a willingness to present the company as favourably as possible exists, according to the theory. However, the empirical investigation showed that the MD&As overall reflected both positive and negative information, suggesting that the management discusses all the significant events that happened during the financial year. This finding concludes that the management wants to present the company in a true and fair view and thereby communicate in a truthful way. However, many of the MD&As did not give much information, which can be explained by the fact that charts were presented. These charts functioned as an explanation of the financial year in figures, instead of words. This indicates that the management communicates in other ways, not only using words. To conclude, the investigation showed that even though the management's communication in the MD&A in some cases may be insufficient, the information reflects the company in a way that is true to the financial statement.

6.5 Recommendations for further research

The investigation made in this thesis contribute to previous studies by claiming that even though the management's communication in the MD&A in some cases may be insufficient, the information reflects the company in the same way as the financial statement. Investigating the same companies during a time of prosperity and seeing whether the same tendencies could be found, would strengthen the result of this investigation and contribute to previous studies. Another alternative would be to do a similar investigation on MD&As longer than five pages, to see if the communication in these MD&As also reflects the truth and has the same tendency to be quiet. A final recommendation for further research would be to do a similar content analysis, but on another part in the narrative section of the annual report.

List of references

Articles

Abrahamson, E & Amir, E 1996, 'The information content of the president's letter to shareholders', *Journal of Business Finance & Accounting*, vol. 23, no. 8, pp. 1157-82.

Aerts, W 2001, 'Inertia in the attributional content of annual accounting narratives', *European accounting review*, vol. 10, no. 1, pp. 3-32.

Beattie, V, McInnes, W & Fearnley, S 2004, 'Through the Eyes of Management: Narrative Reporting Across Three Sectors: Final Report'.

Bedford, NM & Baladouni, V 1962, 'A communication theory approach to accountancy', *The Accounting Review*, vol. 37, no. 4, pp. 650-9.

Boucher, J & Osgood, CE 1969, 'The pollyanna hypothesis', *Journal of Verbal Learning and Verbal Behavior*, vol. 8, no. 1, pp. 1-8.

Clarkson, PM, Kao, JL & Richardson, GD 1994, 'The Voluntary Inclusion of Forecasts in the MD&A Section of Annual Reports*', *Contemporary Accounting Research*, vol. 11, no. 1, pp. 423-50.

Clatworthy, M & Jones, MJ 2001, 'The effect of thematic structure on the variability of annual report readability', *Accounting, Auditing & Accountability Journal*, vol. 14, no. 3, pp. 311-26.

Cooke, T 1989, 'Disclosure in the Corporate Annual Reports of Swedish Companies', *Accounting and Business Research*, vol. 19, no. 74, pp. 113-24.

Davis, AK, Piger, JM, Sedor, LM & Louis, FRBoS 2006, *Beyond the numbers: An analysis of optimistic and pessimistic language in earnings press releases*, Citeseer.

Deegan, C & Rankin, M 1996, 'Do Australian companies report environmental news objectively?: An analysis of environmental disclosures by firms prosecuted successfully by the Environmental Protection Authority', *Accounting, Auditing & Accountability Journal*, vol. 9, no. 2, pp. 50-67.

Eiker, A, Hefzi, H & Glezen, G 2000, 'Prospective information in management's discussion and analysis: A test of incremental information content', *The Journal of Interdisciplinary Studies*, vol. 13, pp. 13-22.

Fulkerson, J 1996, 'How investors use annual reports', *American Demographics*, vol. 18, no. 5.

Gibbins, M, Richardson, A & Waterhouse, J 1990, 'The management of corporate financial disclosure: opportunism, ritualism, policies, and processes', *Journal of Accounting Research*, vol. 28, no. 1, pp. 121-43.

Henderson, B 2004, 'As good as your word', *Financial Management(14719185)*, vol. May, pp. 24-5.

Hildebrandt, HW & Snyder, RD 1981, 'The Pollyanna hypothesis in business writing: initial results, suggestions for research', *Journal of Business Communication*, vol. 18, no. 1, p. 5.

Hutton, AP, Miller, GS & Skinner, DJ 2003, 'The role of supplementary statements with management earnings forecasts', *Journal of Accounting Research*, vol. 41, no. 5, pp. 867-90.

Katz, SB 2001, 'Language and persuasion in biotechnology communication with the public: How to not say what you're not going to not say and not say it', *AgBioForum*, vol. 4, no. 2, pp. 93-7.

Lev, B 1992, 'Information disclosure strategy', *California Management Review*, vol. 34, no. 4, pp. 9-32.

Lev, B & Penman, SH 1990, 'Voluntary forecast disclosure, nondisclosure, and stock prices', *Journal of Accounting Research*, vol. 28, no. 1, pp. 49-76.

Morse, D 1980, 'Asymmetrical information in securities markets and trading volume', *Journal of Financial and Quantitative Analysis*, vol. 15, no. 05, pp. 1129-48.

Pava, ML & Epstein, MJ 1993, 'How good is MD&A as an investment tool?', *Journal of Accountancy*, vol. 175, pp. 51-.

Pfeffer, J 1981, *Power in organizations*, Pitman Publishing.

Postman, L 1953, 'The experimental analysis of motivational factors in perception', *Current theory and research in motivation*, pp. 59-108.

Rogers, JL & Stocken, PC 2005, 'Credibility of management forecasts', *Accounting Review*, vol. 80 No. 4, Oct., pp. 1233-60.

Rogers & Grant, J 1997, 'Content Analysis of Information Cited in Reports of Sell-Side Financial Analysts (Digest Summary)', *Journal of Financial Statement Analysis*, vol. 3, no. 1, pp. 17-30.

Rowe, J 1998, 'No such thing as the language of business: colourless green ideas sleep furiously', *Management Decision*, vol. 36, no. 2, pp. 117-22.

Rutherford, BA 2005, 'Genre analysis of corporate annual report narratives', *Journal of Business Communication*, vol. 42, no. 4, p. 349.

Shannon, CE 2001, 'A mathematical theory of communication', *ACM SIGMOBILE Mobile Computing and Communications Review*, vol. 5, no. 1, pp. 3-55.

Skinner, DJ 1994, 'Why firms voluntarily disclose bad news', *Journal of Accounting Research*, vol. 32, no. 1, pp. 38-60.

Suchman, MC 1995, 'Managing legitimacy: Strategic and institutional approaches', *The Academy of Management Review*, vol. 20, no. 3, pp. 571-610.

Thomas, J 1997, 'Discourse in the marketplace: The making of meaning in annual reports', *Journal of Business Communication*, vol. 34, no. 1, p. 47.

Yuthas, K, Rogers, R & Dillard, JF 2002, 'Communicative action and corporate annual reports', *Journal of Business Ethics*, vol. 41, no. 1, pp. 141-57.

Published references

Bergström, G & Boréus, K 2005, *Textens mening och makt: metodbok i samhällsvetenskaplig text-och diskursanalys*, Studentlitteratur.

Clampitt, PG 2005, *Communicating for Managerial Effectiveness (3rd ed.)*, Thousand Oaks, California: Sage Publications Inc.

Jonäll, K 2006, *Textanalys av VD-brev-med fokus på ansvar och öppenhet*.

Newbold, P, Carlson, WL & Thorne, BM 2002, *Statistics of Business and Economic*.

Weber, RP 1990, *Basic content analysis*, Sage.

Legal framework

FAR SRS, 2009, *Samlingsvolymen 2010 Redovisning*, Stockholm: FAR SRS Förlag AB.

Other references

Törning, E & Ericson, M 2006, *Årsredovisningarna i onoterade bolag bättre*, Balans, Vol. 12, ss 27-30

Annual reports, 2009, electronic form

AB Karlbergs Bilaffär

Acne Studios AB

Besqab Projektutveckling Aktiebolag

Daloc AB

Emballator Ulricehamns Bleck Aktiebolag

Furninova Aktiebolag

Icopal Aktiebolag

Mediacommunications Services Sverige AB

Vällinge Flooring Techlolgy AB

Nordic Light Aktiebolag

Idrottens Spel i Göteborg AB

Rottneros Bruk AB

Fiskhederns Timber Aktiebolag

Fiskarhedens Trävaru Aktiebolag

Celsa Steel Service AB

Lindab Profil Aktiebolag

InfoCare Service AB

Atria Foodservice AB

Tre Son Förvaltning AB

Liber Aktiebolag

Byggmästar'n i Skåne Aktiebolag

Hangartner AB

Thomson Reuters (Markets) Sverige AB

PEDAB Sweden AB

Nordic Paper Seffle AB

Aktiebolaget Bil-Bengtsson

Lenslogistics AB

Valio Sverige Aktiebolag

Nåiden Bygg Aktiebolag

Alimak Hek Aktiebolag

Aktiebolaget Berner & Co

Ahlberg-Dollarstore AB

Getinge Sterilization Aktiebolag

Svenska Lantägg Aktiebolag
 Itella Logistics AB
 Möller Bil Uppsala AB
 Intrum Justitia Sverige Aktieblag
 Freja Transport & Logistics AB
 Novamedia Svenska PostkoLotteriet AB
 UNIT4 Agresso AB
 Environmental Solutions Sweden Holding
 AB
 PWS Waste Systems AB
 Apotek Produktion & Laboratorier AB
 New Wave Sports AB
 Halens AB
 Sergel kredittjänster AB
 SWECO Energuide AB
 TRANSWAGGON AB
 Fiskars Sweden AB
 Vida Borgstena AB
 Ferruform Aktiebolag
 Heving & Hägglund Förvaltning AB
 Akademiska Hus Öst AB
 Höglandets Invest Aktiebolag
 Stadsvapnet i Karlshamn AB
 Forbo Flooring
 Hallpressen AB
 K-J Svedberg Invest AB
 Continental Däck AB
 Proact IT Sweden AB
 LOGSTOR AB
 NordicGSA Holding AB
 Bilia Group Göteborg AB
 AB Falbygdens Ostnederlag
 Lifco Dental Aktiebolag
 Erlandsson Bolagen i Kungsbacka
 Stockholms Åkeri AB
 Anders Öman Holding AB
 Yves Rocher Suede Atiebolag
 Bessmanet Livs AB
 Lantmännen Doggy AB
 A Train Aktiebolag
 ASSA ABLOY ES Production AB
 Luvata Söderköping AB
 HemoCue Aktiebolag
 Sanmina SCI AB
 Peak Performance Production AB
 VFS International AB
 SP Fönster AB
 ArcelorMittal BF Group SSC AB
 EDSA Holdings Sweden AB
 Fred Holmberg & Co Aktiebolag
 AF Bygg Göteborg AB
 Stockholmsmässan Aktiebolag
 Synnersten Invest AB
 BIRKA CRUISES AB
 Autoropa Aktiebolag
 ALD Automotive AB
 Aktiebolaget Sollentunahem
 Henkel Adhesive Techologies Norden
 Aktiebolag
 Rejlers Ingenjörer Aktiebolag
 Johnson Controls Integrated Facility
 Management Nordic Aktiebolag
 Tribe Hotel Management
 Tage & Söner Förvaltnings AB
 ABT Bolagen AB
 Svetruck Aktiebolag
 Privista Capital AB
 Hälla Stormarknad Aktiebolag
 Allfrukt i Stockholm Aktiebolag
 Scorett Foot Wear Aktiebolag
 Lekolar AB
 Atos Medical Holding 2 AB
 Hedin Uppsala Bil AB
 Laird Technologies AB
 Dagens Industri Aktiebolag
 Östgöta Media AB
 Nimbus Boats Holding AB
 Getinge Disinfection Aktiebolag
 Aktiebolaget Borgen
 Evo Bus Sverige Aktiebolag
 PartnerTech Vellinge AB
 Baloc AB
 Meson AB
 EWP Windtower Production
 Bilia Group Stockholm AB
 Vingcar Holding AB
 NC Holding AB
 Berg Propulsion Production AB

TeknikMagasinet Sweden Aktiebolag
Jacobi Carbons AB
THG Axet Aktiebolag
Bergs Skog AB
Tornby Stormarknad AB
Länsförsäkringar Fondförvaltning
Aktiebolag
West Air Sweden Aktiebolag
Kemetyl Aktiebolag
Mjögäcks Entreprenad Aktiebolag
Jönköpings Stormarknad AB
EFG European Furniture Group
Aktiebolag
Roxtec International Aktiebolag
Nacka Trä & Byggvaror Sven Gustafsson
Aktiebolag
Finja Betong AB
CHPH Livs AB
Kronhallen Fastighet Aktiebolag

Grafiska Vägen Livs Aktiebolag
Viking Rederi Aktiebolag
MVB Syd AB
Scandinavian Cosmetics Aktiebolag
Gnosjö Klimatprodukter AB
INCOS AB
Framtidens Stormarknad i Västerås
Aktiebolaget STOKAB
Happy Homes Sverige AB
Deome Byggvaror & Träteknik Aktiebolag
Egmont Kärnan Aktiebolag
Enkla Elbolaget I Sverige AB
Lyreco Sverige AB
Södra Interiör Aktiebolag
Tågia Aktiebolag
Rörvik Skog AB
Kraftringen Nät AB
Skelleftebränslen Aktiebolag

A. Appendix

A.1. Appendix. Complete list of the investigation.

Company	Total amount of sentences in the MD&A	Positive sentences	Negative sentences	Neutral sentences	Net	Profit and loss for the year (SEK thousand)	Equity	(Profit or loss)/ (Shareholders' equity)
UNIT4 Agresso AB	71	15	3	18	12	35182	78271	0,4495
Jacobi Carbons AB	44	11		10	11	6758	50525	0,1338
Proact IT Sweden AB	42	9	2	6	7	20467	42760	0,4786
Aktiebolaget Sollentunahem	52	11	4	16	7	146067	996648	0,1466
Länsförsäkringar Fondförvaltning Aktiebolag	44	8	1	4	7	36901	73460	0,5023
Aktiebolaget STOKAB	36	6		3	6	-11151	173033	-0,0644
Happy Homes Sverige AB	10	6		1	6	1401,584	16016,90	0,0875
Svenska Lantägg Aktiebolag	84	12	7	11	5	1030,274	23171,10	0,0445
Vällinge Flooring Techlogy AB	88	8	4		4	35755	193507	0,1848
Ahlberg-Dollarstore AB	18	5	1	4	4	3476,902	38492,75	0,0903
Bilia Group Göteborg AB	12	4			4	14,612	1,504	9,7154
Fred Holmberg & Co Aktiebolag	32	5	2	1	3	7082,88	12186,08	0,5812
ALD Automotive AB	27	4	1	2	3	1606	20522	0,0783
Meson AB	15	3			3	77273	138781	0,5568
Gnosjö Klimatprodukter AB	22	3		2	3	45543	54846	0,8304
Nordic Light Aktiebolag	33	4	2	1	2	32653,956	114778,147	0,2845
Thomson Reuters (Markets) Sverige AB	12	2		1	2	13542	19330	0,7006
Freja Transport & Logistics AB	16	2		2	2	4711	8010	0,5881
Sergel kreditjänster AB	20	3	1	3	2	65432	18397	3,5567
Fiskars Sweden AB	24	2		6	2	26514	62876	0,4217
Vida Borgstena	14	3	1		2	26039	15426	1,6880

AB								
Akademiska Hus Öst AB	62	3	1	8	2	123539	224535	0,5502
Högländets Invest Aktiebolag	31	2		5	2	16637	94988	0,1751
AF Bygg Göteborg AB	25	5	3	3	2	5942,766	6273,630	0,9473
Stockholmsmässan Aktiebolag	36	5	3	4	2	8858	107928	0,0821
Evo Bus Sverige Aktiebolag	14	3	1	1	2	8994,597	36086,67	0,2492
Nacka Trä & Byggvaror Sven Gustafsson Aktiebolag	15	2		3	2	5988	17672	0,3388
Scandinavian Cosmetics Aktiebolag	9	2		1	2	23455	34085	0,6881
Acne Studios AB	9	2	1	1	1	12253,362	32732,28	0,3744
Mediacommunications Services Sverige AB	12	2	1		1	-85,916	10795,18	-0,0080
Atria Foodservice AB	18	2	1	2	1	24080	5528	4,3560
Novamedia Svenska PostkoLotteriet AB	12	1		3	1	33207	67792	0,4898
PWS Waste Systems AB	5	1		3	1	767	22590	0,0340
Apotek Produktion & Laboratorier AB	26	1		5	1	21156	85232	0,2482
Halens AB	17	2	1	2	1	2902	65985	0,0440
SWECO Energuide AB	34	3	2	1	1	26913	19967	1,3479
Heving & Hägglund Förvaltning AB	10	1			1	2602,558	12892,52	0,2019
Continental Däck AB	17	2	1		1	7054	201677	0,0350
LOGSTOR AB	16	1			1	24668	64399	0,3830
NordicGSA Holding AB	15	2	1	2	1	10894,581	11295,53	0,9645
AB Falbygdens Ostnederlag	19	3	2		1	-645	3713	-0,1737
Bessmanet Livs AB	10	1		1	1	18396,107	5194,142	3,5417
Lantmännen Doggy AB	17	1		5	1	31893	67682	0,4712
BIRKA CRUISES AB	21	2	1	5	1	3685,69	5433,07	0,6784

Johnson Controls Integrated Facility Management Nordic Aktiebolag	21	2	1		1	15617,692	80657,20	0,1936
Tribe Hotel Management	6	1			1	2454	53108	0,0462
Hälla Stormarknad Aktiebolag	5	1			1	23051,255	37813,42	0,6096
Lekolar AB	29	2	1	2	1	33330	291356	0,1144
Atos Medical Holding 2 AB	25	3	2	4	1	61870	325515	0,1901
Aktiebolaget Borgen	24	1			1	6713	121286	0,0553
Baloc AB	30	5	4	3	1	31351	137400	0,2282
TeknikMagasinet Sweden Aktiebolag	21	2	1	6	1	-2726,976	75968,39	-0,0359
West Air Sweden Aktiebolag	26	6	5	2	1	2119	19333	0,1096
Roxtec International Aktiebolag	11	1		1	1	58361	17647	3,3071
Finja Betong AB	41	3	2	3	1	24977	466638	0,0535
Kronhallen Fastighet Aktiebolag	15	1		3	1	9777,115	77708,81	0,1258
Viking Rederi Aktiebolag	34	2	1	4	1	9221,967	22456,06	0,4107
INCOS AB	11	1		3	1	27705	80165	0,3456
Deome Byggvaror & Träteknik Aktiebolag	18	2	1	2	1	3946	81790	0,0482
Egmont Kärnan Aktiebolag	7	1			1	2372	33796	0,0702
Enkla Elbolaget I Sverige AB	9	1		1	1	3944	11421	0,3453
Södra Interiör Aktiebolag	29	3	2	7	1	-8192	147885	-0,0554
Kraftringen Nät AB	20	1		2	1	20502	55471	0,3696
Besqab Projektutveckling Aktiebolag	17			1	0	3396	12707	0,2673
Emballator Ulricehamns Bleck Aktiebolag	29			1	0	4311	183625	0,0235
Idrottens Spel i Göteborg AB	6			2	0	1718,928	15332,77	0,0699
Fiskhederns Timber Aktiebolag	16	1	1	1	0	1053	20613	0,0511
Fiskarhedens Trävaru Aktiebolag	18	1	1	6	0	11920	98652	0,1208

Lindab Profil Aktiebolag	25	1	1	6	0	20461	14401	1,4208
PEDAB Sweden AB	6			1	0	25	7007	0,0036
Aktiebolaget Bil-Bengtsson	22			6	0	5909	105380	0,0561
Nåiden Bygg Aktiebolag	13	1	1	2	0	23913,85	38903,89	0,6147
New Wave Sports AB	9			2	0	-6322	6745	-0,9373
TRANSWAGGON AB	14	1	1	2	0	560	2962	0,1891
Hallpressen AB	20			1	0	1572	109878	0,0143
K-J Svedberg Invest AB	23	1	1	3	0	15420	59443	0,2594
Lifco Dental Aktiebolag	10			1	0	3431	55326	0,0620
Erlandsson Bolagen i Kungsbacka	21			2	0	13694	31828	0,4303
Stockholms Åkeri AB	19	3	3	2	0	-1401	13280	-0,1055
Anders Öman Holding AB	7			2	0	3758	14049	0,2675
ASSA ABLOY ES Production AB	11	1	1	2	0	-6346	52400	-0,1211
HemoCue Aktiebolag	20			2	0	96495	261495	0,3690
Peak Performance Production AB	9			1	0	114663	34438	3,3295
Autoropa Aktiebolag	9			2	0	11453,382	27692,23	0,4136
Svetruck Aktiebolag	7	1	1	2	0	87084	762571	0,1142
Privista Capital AB	24	1	1		0	14285	72218	0,1978
Allfrukt i Stockholm Aktiebolag	14			1	0	12567	19008	0,6611
Scorett Foot Wear Aktiebolag	14			2	0	7656	29554	0,2591
EWP Windtower Production	12			4	0	913	7892	0,1157
Kemetyl Aktiebolag	36	2	2	1	0	22799	27386	0,8325
Mjögåcks Entreprenad Aktiebolag	26	3	3	0	0	5727,558	198130,3	0,0289
Furninova Aktiebolag	29		1		-1	36621,123	45392,88	0,8068
Icopal Aktiebolag	26		1	2	-1	20455	131579	0,1555
Celsa Steel Service AB	15	1	2	1	-1	-7662	946453	-0,0081

Liber Aktiebolag	24	2	3	2	-1	44887	617460	0,0727
Byggmästar'n i Skåne Aktiebolag	23	1	2	1	-1	10866,841	42362,43	0,2565
Hangartner AB	13		1	4	-1	-13062	8189	-1,5951
Nordic Paper Seffle AB	36	3	4	5	-1	-698	39642	-0,0176
Aktiebolaget Berner & Co	28	2	3	3	-1	-1823	39895	-0,0457
Getinge Sterilization Aktiebolag	39	1	2	1	-1	37351	61164	0,6107
Itella Logistics AB	14		1	2	-1	-29909,533	11031,63	-2,7113
Möller Bil Uppsala AB	14		1		-1	-163	15937	-0,0102
Intrum Justitia Sverige Aktieblag	44	1	2	1	-1	1044	156979	0,0067
Environmental Solutions Sweden Holding AB	7		1		-1	2366	2430	0,9737
Stadsvapnet i Karlshamn AB	51		1	5	-1	-9194	179342	-0,0513
Forbo Flooring	18	2	3	3	-1	-4182	28095	-0,1489
A Train Aktiebolag	58	9	10	6	-1	33382	143383	0,2328
Sanmina SCI AB	27	2	3	2	-1	26688	-3200	-8,34
VFS International AB	12		1	2	-1	-139689	510889	-0,2734
EDSA Holdings Sweden AB	29		1	2	-1	-140933	-317742	0,4435
Henkel Adhesive Technologies Norden Aktiebolag	18	1	2		-1	17859	91483	0,1952
Rejlers Ingenjörer Aktiebolag	11		1	2	-1	17973	35785	0,5022
Getinge Disinfection Aktiebolag	31	0	1	1	-1	106505	61972	1,7186
PartnerTech Vellinge AB	27	2	3	4	-1	-5264	75620	-0,0696
NC Holding AB	21	1	2	1	-1	-156	62214	-0,0025
Berg Propulsion Production AB	14		1	1	-1	26362	50236	0,5248
Rottneros Bruk AB	18	4	6	2	-2	1395	124735	0,0112
Alimak Hek Aktiebolag	24	2	4		-2	99245	51087	1,9427
Ferruform Aktiebolag	33	1	3	4	-2	-116747	134229	-0,8698
Yves Rocher Suede Atiebolag	30	1	3	1	-2	28716	76362	0,3761
ArcelorMittal BF Group SSC AB	13	1	3	2	-2	452	25734	6
Bergs Skog AB	16	1	3	1	-2	-4117	3100	-1,3281
Lyreco Sverige AB	35		2	1	-2	18225	66986	0,2721

AB Karlbergs Bilaffär	13	1	4	2	-3	-192	18938	-0,0101
Dagens Industri Aktiebolag	14	0	3	1	-3	54379	16333	3,3294
Nimbus Boats Holding AB	34	1	4	2	-3	-49460	374827	-0,1320
EFG European Furniture Group Aktiebolag	28		3	6	-3	-83864	232173	-0,3612
Tågia Aktiebolag	20	1	4	7	-3	-3957	3732	-1,0603
Rörvik Skog AB	54	2	5	6	-3	-6630	45144	-0,1469
InfoCare Service AB	46	2	6	4	-4	21744	17308	1,2563
Luvata Söderköping AB	17		4		-4	-25171,454	2903,537	-8,6692
Laird Technologies AB	16		4	3	-4	-3465	240963	-0,0144
Daloc AB	12					34151	127298	0,2683
Tre Son Förvaltning AB	5					-10	33314	-0,0003
Lenslogistics AB	10					16169,411	62476,74	0,2588
Valio Sverige Aktiebolag	5					990,5871	29043,98	0,0341
SP Fönster AB	5					-8457	272	-31,0919
Synnersten Invest AB	9					-1036748	4094561 1	-0,0253
Tage & Söner Förvaltnings AB	3					-24	1200	-0,02
ABT Bolagen AB	25					7389,338	155205,6	0,0476
Hedin Uppsala Bil AB	12					12868	39613	0,3248
Östgöta Media AB	4					-30362	18482	-1,6428
Bilia Group Stockholm AB	9					14148,594	26307,75	0,5378
Vingcar Holding AB	5					1101,078	15615,24	0,0705
THG Axet Aktiebolag	10					10139	42955	0,2360
Tornby Stormarknad AB	6					19460,435	20897,96	0,9312
Jönköpings Stormarknad AB	6					40758,366	58161,08	0,7008
CHPH Livs AB	5					13000,134	13121,13	0,9908
Grafiska Vägen Livs Aktiebolag	3					22373,311	22494,21	0,9946
MVB Syd AB	13					52446,69	101746,2	0,5155
Framtidens Stormarknad i Västerås	4					5368,611	6277,343	0,8552
Skelleftebränslen Aktiebolag	4					6114,956	20647,16	0,2962

A.2. Appendix. The name of the companies, which MD&As were used in the investigation.

AB Karlbergs Bilaffär
Acne Studios AB
Besqab Projektutveckling Aktiebolag
Daloc AB
Emballator Ulricehamns Bleck Aktiebolag
Furninova Aktiebolag
Icopal Aktiebolag
Mediacommunications Services Sverige AB
Vällinge Flooring Techlogy AB
Nordic Light Aktiebolag
Idrottens Spel i Göteborg AB
Rottneros Bruk AB
Fiskhederns Timber Aktiebolag
Fiskarhedens Trävaru Aktiebolag
Celsa Steel Service AB
Lindab Profil Aktiebolag
InfoCare Service AB
Atria Foodservice AB
Tre Son Förvaltning AB
Liber Aktiebolag
Byggmästar'n i Skåne Aktiebolag
Hangartner AB
Thomson Reuters (Markets) Sverige AB
PEDAB Sweden AB
Nordic Paper Seffle AB
Aktiebolaget Bil-Bengtsson
Lenslogistics AB
Valio Sverige Aktiebolag
Nåiden Bygg Aktiebolag
Alimak Hek Aktiebolag
Aktiebolaget Berner & Co
Ahlberg-Dollarstore AB
Getinge Sterilization Aktiebolag
Svenska Lantägg Aktiebolag
Itella Logistics AB
Möller Bil Uppsala AB
Intrum Justitia Sverige Aktiebolag
Freja Transport & Logistics AB
Novamedia Svenska PostkoLotteriet AB
UNIT4 Agresso AB
Environmental Solutions Sweden Holding AB
PWS Waste Systems AB
Apotek Produktion & Laboratorier AB
New Wave Sports AB
Halens AB
Sergel kredittjänster AB
SWECO Energuide AB
TRANSWAGGON AB
Fiskars Sweden AB
Vida Borgstena AB
Ferruform Aktiebolag
Heving & Hägglund Förvaltning AB
Akademiska Hus Öst AB
Höglandets Invest Aktiebolag
Stadsvapnet i Karlshamn AB
Forbo Flooring
Hallpressen AB
K-J Svedberg Invest AB
Continental Däck AB
Proact IT Sweden AB
LOGSTOR AB
NordicGSA Holding AB
Bilia Group Göteborg AB
AB Falbygdens Ostnederlag
Lifco Dental Aktiebolag
Erlandsson Bolagen i Kungsbacka
Stockholms Åkeri AB
Anders Öman Holding AB
Yves Rocher Suede Atiebolag
Bessmanet Livs AB
Lantmännen Doggy AB
A Train Aktiebolag
ASSA ABLOY ES Production AB
Luvata Söderköping AB
HemoCue Aktiebolag
Sanmina SCI AB
Peak Performance Production AB

VFS International AB
SP Fönster AB
ArcelorMittal BF Group SSC AB
EDSA Holdings Sweden AB
Fred Holmberg & Co Aktiebolag
AF Bygg Göteborg AB
Stockholmsmässan Aktiebolag
Synnersten Invest AB
BIRKA CRUISES AB
Autoropa Aktiebolag
ALD Automotive AB
Aktiebolaget Sollentunahem
Henkel Adhesive Technologies Norden
Aktiebolag
Rejlers Ingenjörer Aktiebolag
Johnson Controls Integrated Facility
Management Nordic Aktiebolag
Tribe Hotel Management
Tage & Söner Förvaltnings AB
ABT Bolagen AB
Svetruck Aktiebolag
Privista Capital AB
Hälla Stormarknad Aktiebolag
Allfrukt i Stockholm Aktiebolag
Scorett Foot Wear Aktiebolag
Lekolar AB
Atos Medical Holding 2 AB
Hedin Uppsala Bil AB
Laird Technologies AB
Dagens Industri Aktiebolag
Östgöta Media AB
Nimbus Boats Holding AB
Getinge Disinfection Aktiebolag
Aktiebolaget Borgen
Evo Bus Sverige Aktiebolag
PartnerTech Vellinge AB
Baloc AB
Meson AB
EWP Windtower Production
Bilia Group Stockholm AB
Vingcar Holding AB
NC Holding AB
Berg Propulsion Production AB
TeknikMagasinet Sweden Aktiebolag
Jacobi Carbons AB
THG Axet Aktiebolag
Bergs Skog AB
Tornby Stormarknad AB
Länsförsäkringar Fondförvaltning
Aktiebolag
West Air Sweden Aktiebolag
Kemetyl Aktiebolag
Mjögäcks Entreprenad Aktiebolag
Jönköpings Stormarknad AB
EFG European Furniture Group
Aktiebolag
Roxtec International Aktiebolag
Nacka Trä & Byggvaror Sven Gustafsson
Aktiebolag
Finja Betong AB
CHPH Livs AB
Kronhallen Fastighet Aktiebolag
Grafiska Vägen Livs Aktiebolag
Viking Rederi Aktiebolag
MVB Syd AB
Scandinavian Cosmetics Aktiebolag
Gnosjö Klimatprodukter AB
INCOS AB
Framtidens Stormarknad i Västerås
Aktiebolaget STOKAB
Happy Homes Sverige AB
Deome Byggvaror & Träteknik Aktiebolag
Egmont Kärnan Aktiebolag
Enkla Elbolaget I Sverige AB
Lyreco Sverige AB
Södra Interiör Aktiebolag
Tågja Aktiebolag
Rörvik Skog AB
Kraftringen Nät AB
Skelleftebränslen Aktiebolag

A.3. Appendix. List of positive keywords (Clatworthy & Jones, 2003)

Achieve	Gained
Achieved	Gaining
Achievements	Good
Acquired	Grew
Acquiring	Grow
Acquisition	Growing
Acquisitions	Growth
Advanced	Improve
Advances	Improved
Advantage	Improvements
Assist	Improving
Attractive	Increase
Benefit	Increased
Benefited	Increasing
Benefits	Opportunities
Compliment	Opportunity
Confident	Optimistic
Creditable	Outstanding
Develop	Pleased
Developing	Positive
Development	Potential
Developments	Profit
Effective	Profitable
Enable	Progress
Enabled	Prosperity
Encouraging	Prudent
Enhance	Quality
Enhancement	Rebuilding
Enhancing	Recovery
Excellent	Reinvestment
Expand	Resilient
Expanding	Revival
Expansion	Rise
Favourable	Risen
Focused	Robust
Fortunate	Rose
Fulfil	Secure
Fulfilling	Sound
Future	Stabilisation
	Stability

Strength
Strengthen
Strengthened
Strong
Strongly
Succeeded
Success

Successful
Successfully
Support
Up
Upturn
Value

A.3. Appendix. List of negative keywords (Clatworthy & Jones, 2003)

Accident	Negatively
Adverse	Poor
Adversely	Problem
Bad	Problems
Bankruptcy	Recession
Cautious	Recessionary
Challenge	Shortage
Challenges	Slowly
Challenging	Sluggish
Concern	Suffered
Concerned	Tough
Concerns	Troubled
Crisis	Unable
Deficit	Unfavorable
Deficits	Unhelpful
Delay	Unprofitable
Delayed	Unrealised
Delays	Weak
Depress	Weakened
Depressed	Weaker
Deterioration	Weakness
Difficult	Worst
Difficulties	
Disappointed	
Disappointing	
Disappointment	
Down	
Downturn	
Downturns	
Failed	
Failure	
Hazardous	
Inability	
Inadequate	
Lack	
Lose	
Loss	
Losses	
Lost	
Missed	
Negative	