

# Two New Non-invasive Treatment Methods for Otitis Media with Effusion in Children and Obstructive Sleep Apnoea in Adults

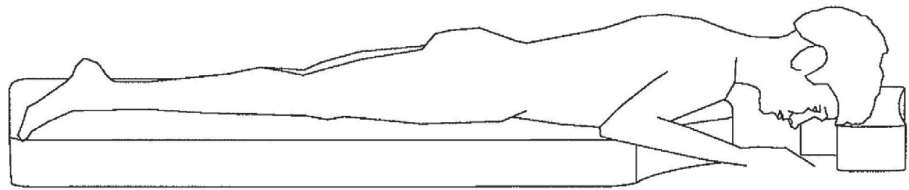

**Armin Bidarian Moniri**

Institute of Clinical Sciences  
at Sahlgrenska Academy  
University of Gothenburg

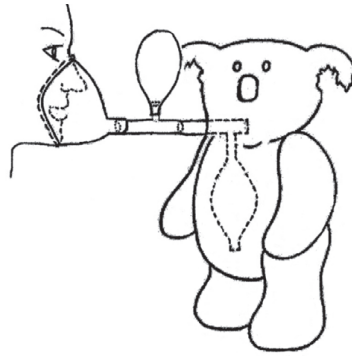



# **Two New Non-invasive Treatment Methods for Otitis Media with Effusion in Children and Obstructive Sleep Apnoea in Adults**

Armin Bidarian Moniri

Department of Otorhinolaryngology, Head & Neck Surgery

Institute of Clinical Sciences

Sahlgrenska Academy at the University of Gothenburg



UNIVERSITY OF GOTHENBURG

Gothenburg 2014

Two New Non-invasive Treatment Methods for Otitis Media with Effusion in  
Children and Obstructive Sleep Apnoea in Adults

© Armin Bidarian Moniri 2014

**ISBN:** 978-91-628-8982-1

Printed in Bohus, Sweden 2014-03-19  
Ale Tryckteam AB



## **Dedication**

*To my mother Mehri,  
for all your sacrifices, without you I would be nothing*

*To my wife Raquel,  
my source of inspiration, everything is possible with you*

*To my brothers Arash & Abtin,  
for your continuous support and guidance that has not ended yet*

*To my daughter Miriam,  
the joy of my life, within you lies my past, present and future*



*Her Majesty Queen Silvia's Jubilee Foundation  
Stockholm Castle, 22 January 2014  
(Photo: Clas-Göran Carlsson)*

*"The woods are lovely dark and deep  
But I have promises to keep  
And miles to go before I sleep  
And miles to go before I sleep"*

*Robert Frost*



## **Two New Non-invasive Treatment Methods for Otitis Media with Effusion in Children and Obstructive Sleep Apnoea in Adults**

Armin Bidarian Moniri

Department of Otorhinolaryngology, Head & Neck Surgery, Institute of Clinical Sciences, Sahlgrenska Academy at the University of Gothenburg

### **ABSTRACT**

Otitis media with effusion (OME) in children and obstructive sleep apnoea (OSA) in adults are common conditions in medicine. Several surgical and non-surgical methods have been suggested for treatment of these diseases. However, to find an appropriate treatment option is a challenging task for the clinician and many patients do not have an optimal treatment for their disease. In this thesis two new non-invasive treatment options were developed and evaluated. Papers 1 and 2 deal with OME in children and papers 3 and 4 concern OSA in adults.

Paper 1 deals with the development of a new device for autoinflation and evaluation of the effect on OME. In a pilot study, the effect of the new device on middle ear pressure was studied in 21 children with persistent OME. In the treatment group 83% of the ears were considered to be responders compared to 30% improvement in the control group during the follow up period.

Paper 2 was a randomised controlled cross-over study evaluating the effect of the new method for autoinflation, with respect to middle ear pressure and hearing thresholds in 45 children with persistent OME awaiting grommet surgery. After four weeks of treatment the mean middle ear pressure and the mean hearing thresholds were improved by 166 daPa and 6 dB hearing level respectively compared to non-significant alterations in the control group. After the cross-over of the control group to treatment, equivalent improvements were achieved. After four weeks of treatment in both groups only four of the 45 included children were operated with grommet due to persistent disease. Both groups were followed up during additional 10 months whereby another five children were submitted to grommet surgery due to disease recurrence. Compliance was satisfactory with all the children performing the manoeuvre.

Paper 3 concerns evaluation of the effect of the prone sleeping position on severity of disease in OSA with polysomnographic (PSG) and polygraphic (PG) sleep studies. During the two-night study, first on a normal mattress with optional positioning and then on a mattress and pillow facilitating prone positioning, the median apnoea-hypopnoea index (AHI) was reduced from 23 to 7 and the oxygen desaturation index (ODI) from 21 to 6. This improvement was achieved by a reduction in the supine and an increase in the prone sleep time.

Paper 4 was an evaluation of the four-week compliance and the effect of the mattress and pillow for prone positioning (MPP) on severity of disease in OSA patients evaluated by PSG. The mean AHI and ODI were reduced from 26 and 21 to 8 and 7 respectively with the MPP. This was achieved with no significant disruption of the sleep architecture and satisfactory compliance in the four-week study.

**Keywords:** Otitis Media with Effusion; Secretory Otitis Media; Autoinflation; Obstructive Sleep Apnoea; Positional Therapy; Conservative, Non-invasive, Non-surgical Treatment Methods

**ISBN:** 978-91-628-8982-1

## ACKNOWLEDGMENTS

*This six-year project has involved many different people and has implemented the base of an international collaboration. Each of the persons involved have had an inestimable part in the progress of the project and the accomplishment of this thesis. I would like to express my sincere gratitude to the following people and organisations:*

***Hasse Ejnell:*** *my supervisor, mentor and friend, no one could ever imagine the adventure that these projects would take us to. Our journey started in 2008 with the crazy idea of experimenting prone positioning in patients with obstructive sleep apnoea. After a couple of hundreds of mattresses and pillows cut by hand, we got the perception that this idea might actually work!*



*None of this would have been possible without you. Words are not enough to express my endless gratitude to you. With your vast clinical experience as well as your sharp scientific eye, I have had the best companion and supervision that I could ever ask for.*

***Lars Rasmusson:*** *my co-supervisor and friend, for believing in me and providing your important support for the project from the very start. Your guidance and optimism were essential to complete this thesis.*

***Luaay Aziz:*** *my brother in arms, for giving me shelter, company and support during the past years along with your wise advises in all matters.*

***Radi Jönsson:*** *head of the ENT-department, at Sahlgrenska University Hospital in Sweden, for always keeping a distant but watchful eye on the project, for your encouragement and support and also for your important feed-back on papers 1 and 2.*

***Johan Hellgren:*** *head of the Sahlgrenska Academy at the ENT department, for your oversight of this thesis and important feed-back on the papers. I look forward to a future collaboration.*

**Ilídio Gonçalves:** head of the ENT-department at Centro Hospitalar do Algarve in Portugal, dear friend and colleague, for your hospitality, encouragement and support during these years.

**Fernando Molina Ruiz:** my dear friend and saviour of the last minute in many matters, for all the time you spent on the graphics and videos for both project.

**Carlos Praça:** my dear brother-in-law, for all the hours you spent making the 3D drawing of many mattresses and pillows.

**Måns Eeg-Olofsson:** my dear friend and colleague, for your warm and encouraging words through the years and also your valuable feed-back on paper 1.

**Ann-Christin Mjörnheim & Henrik Söderström:** my collaborators in Gothenburg, for your assistance in the performance of the sleep studies.

**Jean-Pierre Castro, Lourdes Moreno, Ruben Rojas, & José Croca:** my colleagues in Portugal, for continuous support and for always covering up for me during the periods of absence due to the journeys to Sweden.

**Michael Nilsson:** dear friend and colleague, for your support and encouragement.

**John Attia & Christopher Oldmeadow:** colleagues in Australia, for statistical analysis and feed-back on papers 3 and 4.

**Jenny Almkvist & Peter Wendel (GU-Holding):** for helping me discover the possible potential in these methods.

**Erik Bengtsson & Göran Leonardsson (Sahlgrenska Science Park):** for your wise advices and coaching along the way.

**Amlövs foundation & ACTA- ORL foundation:** for partial financial support for both projects.

**Queen Silvia Jubilee Foundation:** for the honour of recognition by her majesty Queen Silvia's Jubilee Foundation.

*And now the most important persons in my life...*

**Raquel:** my beautiful wife, for believing in me and being my source of continuous inspiration, for all your innovative ideas regarding both projects and most of all for providing the best possible start for our daughter Miriam.

**Mother, Arash, Abtin:** my dear family, for giving me the best possible background for education and development and for guiding me to choose the scientific path. And dear Arash, for your creativity and assistance in the development of both ideas.

**Augusta Praça & Daniel Silva:** my dear mother- and father-in-law, for your support and encouragement during the past years.





## LIST OF PAPERS

### Paper 1.

**Armin Bidarian Moniri**, Maria-João Ramos, Ilídio Gonçalves, Hasse Ejnell

A new device for treatment of persistent otitis media with effusion  
International Journal of Pediatric Otorhinolaryngology, 2013; 77: 2063-70

### Paper 2.

**Armin Bidarian Moniri**, Maria-João Ramos, Hasse Ejnell

Autoinflation for treatment of persistent otitis media with effusion in children: a cross-over study with a 12-month follow-up  
(submitted 2013)

### Paper 3.

**Armin Bidarian Moniri**, Michael Nilsson, Lars Rasmusson, John Attia, Hasse Ejnell

The effect of the prone sleeping position on obstructive sleep apnoea  
(submitted 2014)

### Paper 4.

**Armin Bidarian Moniri**, Michael Nilsson, John Attia, Hasse Ejnell

Positional treatment for obstructive sleep apnoea with a mattress and pillow for prone positioning  
(submitted 2014)

# CONTENTS

Abbreviations	
Introduction	17
Thesis outline	18
OME	
Historical background	20
Definitions	21
Epidemiology	21
Pathophysiology	21
Anatomy of the eustachian tube	22
Physiology of the eustachian tube	22
Middle ear effusion	23
Diagnostic measurements and Methods	23
Pneumatic otoscopy/otomicroscopy	23
Tympanometry	24
Threshold audiometry	24
Pure-tone audiometry	24
Sound field audiometry	25
Treatment options	25
Grommets	25
Adenoidectomy	26
Autoinflation	26
Other treatment options	26
Background of the hypothesis	26
Hypothesis and aims	27
Paper summaries 1 & 2	28
Material and methods	28
Development of a new device for autoinflation	28
The combined Valsalva-Politzer effect	30
Diagnostic methods	31
Results	31
Discussion	32
Conclusions	32
Future perspectives	32
OSA	
Historical background	34
Definitions	35
Snoring and upper airway resistance syndrome	
Obstructive sleep apnoea	
Epidemiology and comorbidity	36
Prevalence	36
Age	36
Gender	36
Obesity	36
Cardiovascular disease	36

Pathophysiology	37
Airway anatomy	37
Airway physiology	38
Snore induced mechanical damage & gastro-oesophageal reflux disease	40
Diagnostic measurements and methods	40
Sleep study	40
Positional sleep apnoea & night-to-night variability	42
Questionnaires	42
Other examinations	43
Treatment options	44
Lifestyle	44
Continuous positive airway pressure	44
Mandibular advancement device	44
Surgery	45
Positional therapy	45
Background of the hypothesis	46
Hypothesis and aims	48
Paper summaries 3 & 4	49
Material and methods	49
A new mattress and pillow for prone positioning	49
Diagnostic methods	53
Results	53
Discussion	53
Conclusions	54
Future perspectives	54
Summary in Swedish-Populärvetenskaplig sammanfattning	56
Bibliography	59
Appended original papers	73

## ABBREVIATIONS

<i>AASM</i>	<i>American Association of Sleep Medicine</i>
<i>AHI</i>	<i>Apnoea-Hypopnoea Index</i>
<i>ASHA</i>	<i>American Speech-Language-Hearing Association</i>
<i>cm H<sub>2</sub>O</i>	<i>Centimeter Water</i>
<i>CPAP</i>	<i>Continuous Positive Airway Pressure</i>
<i>CT</i>	<i>Computer Tomography</i>
<i>daPa</i>	<i>DecaPascal</i>
<i>dB</i>	<i>Decibel</i>
<i>dB HL</i>	<i>Decibel Hearing Level</i>
<i>EEG</i>	<i>Electro-Encephalogram</i>
<i>EDS</i>	<i>Excessive Daytime Sleepiness</i>
<i>EMG</i>	<i>Electromyography</i>
<i>EOG</i>	<i>Electro-Oculogram</i>
<i>ESS</i>	<i>Epworth Sleepiness Scale</i>
<i>Et al.</i>	<i>et alii</i>
<i>GERD</i>	<i>Gastro-Oesophageal Reflux Disease</i>
<i>h</i>	<i>hour(s)</i>
<i>HR</i>	<i>Hazard Ratio</i>
<i>Hz</i>	<i>Herz</i>
<i>ODI</i>	<i>Oxygen Desaturation Index</i>
<i>OME</i>	<i>Otitis Media with Effusion</i>
<i>OSA</i>	<i>Obstructive Sleep Apnoea</i>
<i>OSAS</i>	<i>Obstructive Sleep Apnoea Syndrome</i>
<i>PG</i>	<i>Polygraphy</i>
<i>PSG</i>	<i>Polysomnography</i>
<i>MAD</i>	<i>Mandibular Advancement Device</i>
<i>MLST</i>	<i>Multiple Sleep Latency Test</i>
<i>MWT</i>	<i>Maintenance of Wakefulness</i>
<i>MRI</i>	<i>Magnetic Resonance Imaging Scan</i>

<i>P</i>	<i>Probability value</i>
<i>POSA</i>	<i>Positional Obstructive Sleep Apnoea</i>
<i>PTA</i>	<i>Pure Tone Average</i>
<i>REM</i>	<i>Rapid Eye Movement Sleep</i>
<i>RTC</i>	<i>Randomised Controlled Trials</i>
<i>SaO2</i>	<i>Oxygen Saturation</i>
<i>SBU</i>	<i>Statens Beredning för Medicinsk Utvärdering Swedish Council on Technology Assessment in Health Care</i>
<i>SFA</i>	<i>Sound Field Audiometry</i>
<i>UARS</i>	<i>Upper Airway Resistance Syndrome</i>
<i>UPPP</i>	<i>Uvulopalatopharyngoplasty</i>



## INTRODUCTION

The continuous search for new methods to treat diseases emanates from the fundamentals of the medicine. Two frequent conditions in the clinical everyday life of an otorhinolaryngologist are otitis media with effusion (OME) and obstructive sleep apnoea (OSA). Treatment options for these conditions include surgical interventions under general anaesthesia. Recent national and international recommendations plead for implementation of conservative treatments for these diseases<sup>1-3</sup>. However, previous non-surgical methods have shown to have a variable success rate regarding efficiency and/or compliance in treating the patients suffering from the mentioned conditions<sup>4-9</sup>.

Otitis media with effusion (OME) is caused by accumulation of fluid in the middle ear, without the signs or symptoms of an acute inflammation or infection<sup>10-12</sup>. OME is the most common cause of hearing impairment in children and is the most common causes of surgical intervention under general anaesthesia in children<sup>13</sup>. The hearing impairment can vary and may cause delay in speech development<sup>14,15</sup>.

Historical evidence indicates that surgical treatment to re-establish the middle ear ventilation via myringotomy, has been performed during the past centuries<sup>16</sup>. An alternative method, i.e. autoinflation, is based on opening of the eustachian tube, by forced introduction of air either by the Valsalva manoeuvre or the Politzer method<sup>17,18</sup>. Despite proved efficiency autoinflation has had limited success in treatment of OME in children mainly due to limited compliance<sup>19</sup>.

Two consecutive Cochrane reports on autoinflation give a relatively weak recommendation on the use of autoinflation for treatment of OME<sup>9,20</sup>. Due to the high rate of spontaneous resolution of the disease and the costs and complications associated with the surgical treatment, “watchful waiting” has been recommended as the first line of treatment<sup>13,21</sup>. The practical dilemma is to allow a child to have a hearing disability during this period of “waiting” with no reliable conservative treatment options.

“Five billion people go through the cycle of sleep and wakefulness everyday, relatively few of them know the joy of being fully rested and alert all day long”<sup>22</sup>. An interesting statement by William Dement, which may draw the attention towards the prevalence of OSA in the society. Indeed with increasing age many people will eventually develop snoring and possibly also OSA<sup>23</sup>.

Obstructive sleep apnoea syndrome (OSAS) affects about 2-4%<sup>23</sup> of the population and is defined by repetitive total or partial upper airway collapses, which reduce the airflow, despite respiratory effort<sup>24</sup>. OSAS causes fragmented sleep due to repetitive awakenings and is associated with an increased risk of excessive daytime sleepiness, cardiovascular diseases and traffic accidents<sup>25-27</sup>.

After the introduction of uvulopalatopharyngoplasty (UPPP) in Sweden in the 1980's, this method was the dominating treatment during about a decade. A recent recommendation from the American college of physicians and also the Swedish Council on Health technology Assessment (SBU) emphasize Continuous Positive Airway Pressure (CPAP) as the gold standard of treatment and the Mandibular

Advancement Device (MAD) as an alternative therapy<sup>1,2</sup>. Due to insufficient evidence regarding UPPP, this treatment option has not been recommended<sup>1,2,28</sup>. CPAP and MAD have shown to be insufficient to treat all the patients suffering from OSA due to limited compliance and/or efficiency, leaving many patients with no other reliable treatment option<sup>4-7</sup>.

## **Thesis outline**

The difficulties in finding “the right” conservative treatment option for children with persistent OME and adults with OSA is a moral and practical dilemma for the clinician. Current recommendations for treatment are based on the scientific evidence regarding each treatment modality.

One never becomes really aware of the consequences of a certain medical condition and the practical problems related to the treatment options before a personal close-encounter. Snoring and sleep apnoea are indeed conditions that compromise the patient, the spouse and also the society. In the author’s case, living with a spouse suffering from upper airway resistance syndrome (UARS), with inability of adaptation to the current treatment options was a wake-up call to start this thesis and to try to develop an alternative solution for snoring and OSA.

Another inspiration for the development of an alternative treatment for persistent OME came from the parents demanding a safe, non-surgical solution, which permitted rapid treatment initiation and disease resolution. Indeed “watchful-waiting” for 3-6 months and/or surgical intervention under general anaesthesia are not acceptable options for many parents. The conclusions regarding the high rate of spontaneous resolution<sup>29-31</sup> or unaltered quality of life at long-term follow-ups<sup>32</sup>, do not exclude the possibility that many children may suffer from their disease during the “watchful waiting” period.

At an initial phase an extensive literature search including the Pubmed, Cochrane library, Google and also patent databases was performed to identify the existing treatment options in both diseases. With the obvious risk of “not seeing the wood because of the trees”, it was also essential to “go back to the origins” and study the pathophysiological bases of each disease to predict possible effect of any new treatment alternative.

The studies in the thesis are based on original ideas and include the development of two non-invasive treatment methods for OME (Device for Equalisation of the Pressure in the Middle Ear, WO/2012/053970) and OSA (Pillow and Mattress for Reducing Snoring and Sleep apnoea, WO/2012/057682). Papers I & II deal with OME including description, and testing of the device for autoinflation in children with persistent OME. Papers III & IV deal with evaluation of the effect of the prone sleeping position on the severity of disease in patients with OSA, introducing a new mattress and pillow facilitating prone positioning.

In this thesis the words conservative and non-invasive are used as synonyms for non-surgical and the abbreviation dB (decibel) as synonym for dB HL (decibel hearing level).



# **OTITIS MEDIA WITH EFFUSION**

## HISTORICAL BACKGROUND

The history of a non-surgical treatment for maintenance of a “healthy” middle ear by autoinflation goes at least back to the 1700<sup>th</sup> century. Antonio Maria Valsalva (1666-1723) described the communicating tubal structure between the middle ear and the nasopharynx and named it after the Italian anatomist Bartolomeu Eustachi<sup>17</sup>. Valsalva described also a manoeuvre consisting of performance of forced nasal expiration with the nose and the lips sealed, i.e. the Valsalva manoeuvre. Even though the manoeuvre proved to be efficient in improving the negative pressure in the middle ear, it did not gain ground for the treatment of OME in children due to the difficulties in performance for young children.

The Politzer method of inflation, was developed by the Hungarian physician Ádám Politzer (1835-1920), as an tentative to overcome the difficulties associated with autoinflation by the Valsalva manoeuvre<sup>18</sup>. The Politzer method involves inserting the tip of a rubber air bulb into one nostril, while sealing the other nostril, the rubber bulb is squeezed while the patient swallows causing tubal opening<sup>33</sup> (Figure 1). Due to the uncontrolled pressure produced by the pump and the subsequent discomfort and/or pain associated with the procedure, limited collaboration was achieved from the child. The classical Politzer procedure was in use during the 20<sup>th</sup> century<sup>33</sup> but has mostly been abandoned during the last decades.



**Figure 1**

*Left: the classical Politzer pump*

*Right: A child blowing up a carnival balloon*

*(Images from Mudry 2000 and Hunt-Williams 1968)*

In 1968 Hunt-Williams presented a new method for autoinflation in children involving a plastic end-piece connected to either a carnival toy or a balloon (Figure 1). The plastic end piece was adapted to a nostril and whilst the other nostril was occluded the child was instructed to blow his/her nose<sup>34</sup>. The method was later refined and presented as the Otovent© device by Stangerup<sup>35</sup>. Even though beneficial effect has been observed, compliance has been a problem, especially in young

children<sup>19</sup>.

The Cochrane reports in 2006 and 2013 evaluating the previous autoinflation methods gave a relatively weak recommendation for the use of this line of treatment in children with OME<sup>9,20</sup>. The recommendation was based on the existing studies being of short treatment and follow-up time with the lack of adequate hearing evaluation.

## DEFINITIONS

Otitis media with effusion (OME) consists of accumulation of fluid in the middle ear, in the absence of signs or symptoms of an acute inflammation or infection<sup>10,11</sup>. OME is the most common cause of acquired hearing loss in childhood<sup>10</sup>. The hearing loss may be significant particularly when the disorder is bilateral and has lasted for more than a month<sup>36</sup>. OME may have linguistic, developmental, behavioural and other social consequences, particularly if the effusion is bilateral and of long duration<sup>11,14,37</sup>.

## EPIDEMIOLOGY

It is difficult to estimate the exact prevalence and incidence of OME in children. The disease is common between the ages of one and three years and in seasons when there is a high incidence of the common cold. The cumulative incidence to the age of four years is approximately 80%<sup>38</sup> and at age seven the prevalence is still 3% to 8%<sup>36,39</sup>.

The Swedish council on health technology assessment (SBU) reports an annual incidence of 400.000 children affected by OME in Sweden with a population of 10 million inhabitants<sup>21</sup>. Almost two thirds of the cases are believed to heal within a month and approximately 90% within 6 months<sup>21</sup>. The SBU also reports that approximately 10.000 children undergo grommet surgery per year in Sweden of which about 75% with the indication longstanding OME<sup>21</sup>. According to these statements many children have OME during several months with no specific treatment, 40.000 children have longstanding OME with disease duration  $\geq 6$  months, of which  $< 20\%$  receive active treatment with grommets.

## PATHOPHYSIOLOGY

The exact aetiology of OME is uncertain, but microbial load, upper respiratory tract infection, acute otitis media, adenoid hypertrophy, and the immune response appear to play an important role<sup>12,30,40</sup>. However, most of the hypotheses regarding the pathophysiology of OME seem to include eustachian tube dysfunction.

## Anatomy of the eustachian tube

The middle ear communicates with the nasopharynx through the eustachian tube. (Figure 2). The eustachian tube consists of cartilage, surrounding soft tissue, peritubal muscles (i.e. tensor veli palatini, levator veli palatini, salpingopharyngeus and tensor tympani) and a superior bony support<sup>41</sup>.

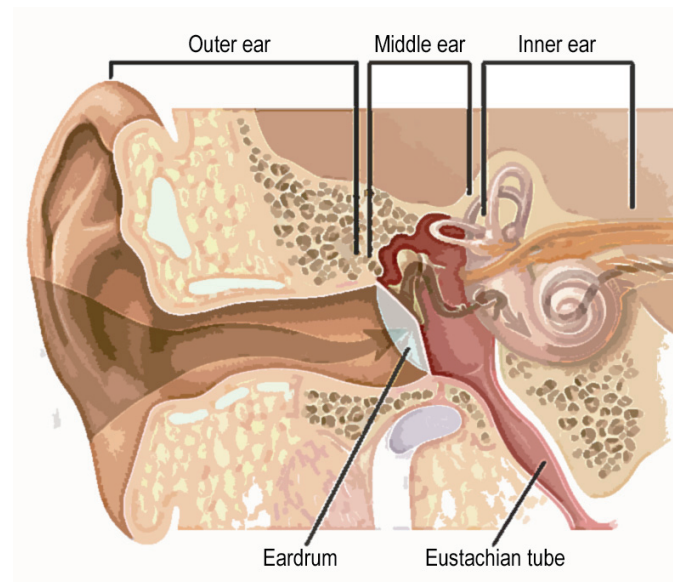

**Figure 2**

*The anatomy of the ear*

*(Image from Deposit photos)*

The eustachian tube in young children is short, floppy, more horizontal and therefore functions poorly<sup>42</sup>. These anatomical considerations are believed to cause the high prevalence of OME in young individuals. Maturation of the tube is a gradual process, which explains the infrequency of OME after the age of 7 years<sup>43,44</sup>.

## Physiology of the eustachian tube

The eustachian tube plays an important role in maintaining the middle ear healthy<sup>42,45</sup>. The three principal functions attributed to the eustachian tube are pressure regulation, protective function and clearance of secretions. In an intact normal middle ear, the eustachian tube is the only “ventilation canal”, equilibrating the pressure between the middle ear and the ambient air<sup>42,46</sup>. The tube is usually collapsed but a physiological pressure equalization of the pressures is produced by contraction of the tensor veli palatini muscle during swallowing, leading to an intermittent active opening of the tube<sup>47,48</sup>. The eustachian tube has also shown to “pump” liquid out of the middle ear<sup>47,49</sup>. Clearance of secretions from the middle ear is provided by the mucociliary system of the eustachian tube and the middle ear mucous membrane<sup>42,50</sup>.

Several processes are recognised to cause a dysfunction of the tube. A narrowing or

obstruction of the eustachian tube may be caused by inflammation secondary to upper airway infection<sup>51-53</sup>, allergy<sup>54</sup> or by a tumour or hypertrophic adenoid mass<sup>55,56</sup>. Even though the prevalence of gastroesophageal reflux disease in children with OME is reported to be higher than the overall prevalence for children, a cause-effect relationship has not been fully confirmed<sup>57</sup>.

### *Middle ear effusion*

A study by Bylander et al. study revealed that 36% of the otologically healthy children could not equilibrate an applied negative intratympanic pressure by swallowing, whereas only 5% of the adults were unable to perform this<sup>58</sup>. Young children between 3 and 6 years had apparently worse function than those of ages 7 to 12 years<sup>58</sup>. Hence eustachian tube function seems to be reduced even in otologically normal children and an improvement of function is observed with increasing age.

One of the most established theories regarding the development of the effusion, postulate that the eustachian tube dysfunction causes a gas exchange from the middle ear into the microcirculation of the mucous membrane leading to a negative pressure in the middle ear, followed by transudation and effusion<sup>59,60</sup>.

Several mechanisms seem to coexist causing a persistent middle ear effusion. Stimulation of cytokines from inflammatory cells in the middle ear mucosa<sup>61,62</sup>, followed by up-regulation of the submucosal receptors and the stimulation of the inflammatory mediators<sup>63</sup> may promote fluid leakage from the mucous membrane. A subsequent increase in blood flow within the mucous membrane, caused by vasodilatation and angiogenesis, may result in further negative pressure and persistent middle ear effusion<sup>64</sup>.

## **DIAGNOSTIC MEASUREMENTS AND METHODS**

The recommended technique for the diagnosis of OME is otomicroscopy or pneumatic otoscopy in combination with tympanometry<sup>13,21</sup>. For objective evaluation of hearing impairment, pure tone audiometry (PTA) or sound field audiometry (SFA) is performed.

### **Pneumatic otoscopy/otomicroscopy**

The experience of the examiner seems to influence the reliability in detection of OME. In some studies binocular microscopy performed by staff paediatric otolaryngologist demonstrates the best test reliability compared with both pneumatic otoscopy and tympanometry<sup>65,66</sup>. Pneumatic otoscopy is reported to have a higher sensitivity to detect middle ear effusion than tympanometry<sup>67</sup> and is reported to be the most accurate method when combined with tympanometry<sup>21</sup>.

## Tympanometry

Tympanometry is typically performed with a handheld device to assess the acoustic energy transfer through the middle ear system. The standard tympanometry probe tone frequency is 226 Hz (as applied in papers 1 & 2), although many additional probe frequencies may be applied<sup>68</sup>.

Energy transfer in the normal middle ear is maximal at atmospheric pressure (0 daPa) and is reduced at air pressures that produce stiffening of the middle ear system<sup>69</sup>. With a reduced mobility of the tympanic membrane due to accumulation of liquid within the middle ear, the tympanometry may present a flat curve with a relative gradient less than 0.1, type B, or a curve with a middle ear pressure between -399 to -200 daPa, type C<sup>70,71</sup> (Figure 3). Type A and C1 tympanograms are not considered to represent otitis media with effusion. Tympanometry has high specificity but relatively low sensitivity as a diagnostic test for OME<sup>67</sup>.

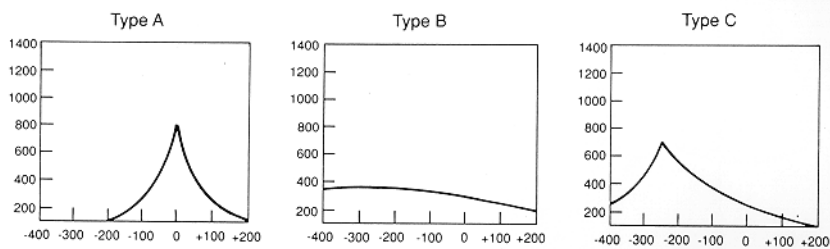

**Figure 3**  
*Tympanogram types A, B and C*

## Threshold audiometry

One of the frequently used methods for hearing evaluation is the pure-tone audiogram. Hearing thresholds may also be measured by speech stimuli. The developmental age of the child determines the appropriate examination in order to establish the hearing thresholds<sup>72</sup>. For young children the procedures should be modified to meet the developmental demands e.g. with conditioned play audiometry<sup>73</sup> (as applied in paper 2). For detection of accurate thresholds, the examination should be performed in sound isolated chambers<sup>74</sup> (as performed in paper 2).

### *Pure-tone audiometry*

For the assessment of hearing thresholds, pure-tone audiogram is used. The hearing thresholds are measured separately in each ear for pure-tone signals, which are single-frequency tones generated electronically and transduced through an earphone (air conduction) or vibrator (bone conduction)<sup>75</sup>.

A threshold is defined as the lowest decibel hearing level (dB HL) at which responses occur in  $\geq 50\%$  of a series of ascending trials<sup>73</sup>. The generally tested frequencies are

250, 500, 1.000, 2.000, 3.000, 4.000, 6.000 and 8.000 Hz and the classification of the degree of hearing loss is usually based on the mean air conduction pure-tone thresholds at 500, 1000, and 2000 Hz also called pure tone average (PTA 512)<sup>73</sup>.

### *Sound field audiometry*

Hearing assessment by sound field audiometry can be appropriate in young children and adults that do not collaborate in the performance of pure tone audiometry<sup>76</sup>. By this test method the stimuli are presented by a loudspeaker, which involves several additional factors, which may influence the sound intensity within the field and subsequently the listener's perception. These factors include the noise level and the acoustic characteristics in the test room, the position and the distance of the test subject to the loud-speaker as well as the acoustic properties of the test signal<sup>76</sup>. The test result is not ear specific and is generally interpreted as the best hearing ear<sup>72</sup> (as applied in paper 2).

## **TREATMENT OPTIONS**

OME has a high rate of spontaneous resolution with several reports indicating an approximate resolution of 20% in one month and 40% in three months<sup>29-31</sup>. The Swedish SBU reports an even higher spontaneous resolution of OME with two thirds healing within a month and 90% within 6 months<sup>21</sup>. Based on the self-limited nature of most OME, current clinical practice guidelines recommend watchful waiting for at least 3 months in otherwise healthy children<sup>13,21,77,78</sup>.

### **Grommets**

The insertion of grommets into the eardrum under general anaesthesia is the most common paediatric surgical procedure and is associated with considerable health care costs<sup>32,78</sup>. The primary indication is restoration of normal hearing in children with long-standing bilateral OME<sup>21</sup>. Even though controversial, grommets are also used in the prevention of recurrent acute otitis media<sup>21</sup>.

The grommet operation consists typically of an anterior inferior myringotomy, with or without aspiration of the middle ear fluid and insertion of a ventilation tube<sup>79</sup>. The rationale for the procedure is to improve ventilation and pressure regulation in the middle ear<sup>12</sup>. There is a remarkable variation in the frequency of the operation, both between countries and between different districts in the same country<sup>80,81</sup>. For example, In Sweden, roughly 10.000 children receive grommets annually. The annual rate per 1000 children is about 2-3 times higher in Denmark and the Netherlands compared to Sweden and Norway.

A 2010 Cochrane review of 10 randomised controlled trials (RCT) concluded that tubes are beneficial for the outcome of hearing in the short term, but the size of the benefit diminishes after 6 to 9 months with no differences seen at 12 and 18 months<sup>3</sup>. The Swedish SBU report finds strong evidence that tympanostomy tubes improve hearing and quality of life in the short term (up to 9 months) with no detectable long-



term effects on language, speech development and cognitive or quality-of-life outcomes<sup>32</sup>.

## **Adenoidectomy**

In a systematic review from 2014 Wallace et al. compared adenoidectomy to grommets, myringotomy or watchful waiting in children with OME<sup>82</sup>. Adenoidectomy alone or as an adjunct to myringotomy, reduced OME and improved hearing in comparison with either myringotomy or watchful waiting.

## **Autoinflation**

“Autoinflation” refers to the opening and forcing of air through, the eustachian tube by the raising of intranasal pressure<sup>9</sup>. This may be achieved by several different methods. The aim of these procedures is to introduce air into the middle ear, via the eustachian tube, equilibrating the negative middle pressure.

The most important techniques for autoinflation were presented in the historical background section. The Cochrane reviews from 2006 and 2013 concluded that the overall effect of autoinflation for treatment of OME in children is conflicting but may be suggestive of clinical benefit in the short term and that the type of device for autoinflation may influence the treatment outcome<sup>9,20</sup>.

## **Other treatment options**

The most common medical treatment options include decongestants, mucolytics, steroids, antihistamines and antibiotics. Antihistamines and descongostants are ineffective for OME and not recommended for treatment<sup>83</sup>. Antibiotics and corticosteroids do not have long-term efficacy and are not recommended for routine management of OME either<sup>84</sup>.

## **BACKGROUND OF THE HYPOTHESIS**

Several contributing factors to the development and persistence of OME in children have been identified and most of the pathophysiological explanation models include an eustachian tube dysfunction. Several methods for non-surgical ventilation of the middle ear, i.e. autoinflation, have been developed and tested<sup>17,18,33-35,85</sup>. However, no conservative method has gained sufficient ground to be recommended as the first line of treatment before surgical intervention.

The study of previous methods of autoinflation was essential to identify the possible modifications needed for improved treatment outcome. The classical Valsalva manoeuvre<sup>17</sup>, is difficult to perform for most children<sup>86</sup> and also many adults.



Different devices have therefore been developed to help children equalize the negative pressure in the middle ear.

The Politzer method of autoinflation<sup>18</sup> has shown to be efficient in equilibrating the negative pressure in the middle ear<sup>33,85</sup>, however due to the associated discomfort the procedure is not frequently used in clinical practice.

The Otovent® method of autoinflation produces primarily a modified Valsalva effect<sup>35</sup>. This method involves a plastic end-piece covered with a balloon on one end and adapted to one nostril with the other. While holding the other nostril closed, the patient is instructed to close the mouth and inflate the balloon through the nose in order to increase the intranasal pressure and open the eustachian tube. The method is practically difficult to perform in young children<sup>19</sup> and may cause discomfort and/or pain.

Another device for autoinflation is the Earpopper®<sup>87,88</sup>, which is based on a modified Politzer manoeuvre. This method involves an automated airpump. The device is adapted to one nostril and while holding the other nostril closed, air is pumped into the nose to increase the intranasal pressure<sup>87</sup>. This device is recommended from four years of age and is not commercialized in Sweden.

All the previously described methods are based on either the Valsalva or the Politzer methods and are in general difficult or uncomfortable for the young child to perform. An optimal OME treatment should take into account the point of view of a young child typically 2-4 years old. The treatment should combine high efficiency in ventilating the middle ear with no associated discomfort or other adverse effects, implemented as an amusing toy in order to fulfil satisfactory compliance and repeatability in case of disease recurrence.

## **HYPOTHESIS AND AIMS**

One of the aims of the present thesis was to develop and study the effect of a non-invasive device in treatment of OME in children. A summary of the major research hypothesis is presented below.

### **Is autoinflation efficient for treatment of young children with persistent OME?**

Several of the previous methods of autoinflation were able to show improvement in the severity of disease. Nevertheless, inclusion of children with disease duration < 3 months, the lack of adequate hearing evaluation and long-term follow-up and also the difficulties in the application of the treatments in young children caused a diversion in the acceptance of these treatments by the clinicians and the patients.

## **What caused the limited success in the previous methods and how can they be avoided?**

Previous autoinflation methods were based on either the Valsalva manoeuvre or the Politzer method. The limitations in these methods were identified and a new device was developed to enable a combined modified Valsalva-Politzer effect, with the objective of increasing efficiency and compliance and also avoiding complications even in the youngest children. The new device was presented as a funny toy.

## **What is the short versus long-term efficiency and compliance with the new device in children with persistent OME?**

The effect of any new treatment is the result of a combination of several controllable and uncontrollable factors that may influence on the end outcome. The new method and device for autoinflation needed clinical testing with elimination/reduction of the confounding factors and evaluation of the short- and long-term effects regarding middle-ear pressure and hearing. A randomised controlled trial with a cross-over setting and a total follow-up time of 12 months was performed.

## ***PAPER SUMMARIES 1 & 2***

This chapter will primarily deal with general aspects of the applied methodology and the achieved results in the papers 1 and 2 regarding OME. Some of the most crucial steps in the development of the new treatment will be illustrated. For detailed research protocol and results regarding each experiment, the reader is referred to the respective manuscript.

### **Material and methods**

#### *Development of a new device for autoinflation*

A new autoinflation device (Figure 4) for home treatment of children with persistent OME was created. The device was developed to enable a combination of the Valsalva manoeuvre and the Politzer method.

The device consisted of (1) an inflatable facemask, (2) a T-shaped junction tube connecting at one end to the facemask, another end to (3) a balloon and the third end to (4) a handheld pump. The pump was covered by (5) a teddy bear in order to improve compliance in young children.

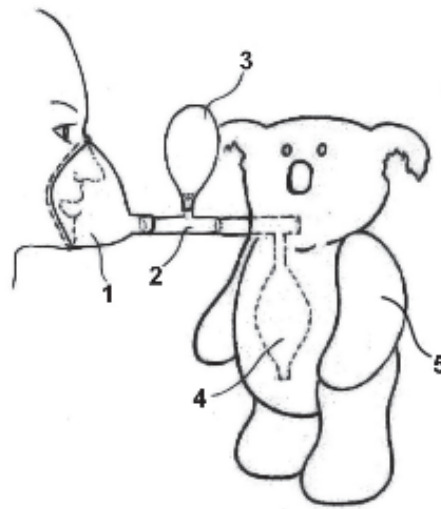

**Figure 4.** The device for autoinflation consisting of (1) a facemask, (2) a T-shaped junction tube, (3) a balloon, (4) a handheld pump and (5) a teddy bear.

The inflatable facemask was used to cover the nose and mouth of the child, with individual adaptations in size. The parent helped the child to adapt the facemask in order to avoid air leakage during the manoeuvre. The balloon was implemented for pressure regulation and visual feedback on a correct manoeuvre to the child and the parent. The balloon functioned also as an air reservoir producing a counter-pressure for a few seconds. Three different balloons with the respective opening pressures of  $20 \pm 3$ ,  $40 \pm 2$  and  $60 \pm 5$  cm H<sub>2</sub>O were used.

With the mask adapted to the face, the child could still inspire through the system with little or no resistance. Whenever the child expired with the mask adapted, the air would be captured within the system and would cause an increase in the pressure, which would blow up the balloon. The fact of covering both nose and mouth permitted the child to choose to whether inflate through the mouth or the nose. As long as the mask was held in place a pressure increase in nasopharynx could be expected.

The handheld pump with a total volume of 250 ml was also incorporated into the device. The pump, covered by a teddy bear, was used to introduce air into the system, facilitating the inflation of the balloon whenever necessary. To control the pressure produced by the handheld pump, a safety valve of 40 cm H<sub>2</sub>O was installed in the system. The child would be able to blow up balloons with different opening pressures ( $\leq 60 \pm 5$  cm H<sub>2</sub>O) via the facemask, but any pressure exceeding 40 cm H<sub>2</sub>O produced by the pump would activate the safety valve. The compliance in the balloon provided another security mechanism, limiting the maximum pressure produced in the system.



**Figure 5**  
*A three-year old child using the new device for autoinflation*

The balloons with the lowest pressure were initially used to help the child become familiar with the device. Within the first day of treatment, the balloon type was changed to another one with opening pressure of  $\geq 40$  cm H<sub>2</sub>O. The parents were advised to replace the balloons each day in order to maintain the desired pressure during the treatment. Middle-ear ventilation was considered to have taken place if the child mentioned symptoms such as mild transient discomfort, sensation of air, water, alteration in hearing or a crackling sound in one or both ears. The final balloon type chosen for treatment was determined when the child mentioned one or several of the above-mentioned symptoms.

#### *The combined modified Valsalva-Politzer effect*

By inflating the balloon with the mask adapted, the child would achieve a modified Valsalva effect. Pumping air into the system would produce a modified Politzer effect. Both effects were mediated by the resistance and the compliance in the balloon (Figure 5). Another method facilitating middle ear ventilation by the act of tensor veli palatini muscle<sup>47,48</sup>, was to ask the child to swallow with the mask adapted and the balloon inflated. This procedure required a certain level of coordination and collaboration from the child and was not applied as a standard procedure in the studies.

In paper 1 tympanometry and otomicroscopy were performed at inclusion and after four weeks. In paper 2 audiometry, tympanometry and otomicroscopy were performed at inclusion and after one, two, six and 12 months. During the follow-up period, when a new episode of OME was detected, a control was scheduled within eight weeks and in case of persistent OME, a new four-week period of treatment was initiated.

## Diagnostic methods

By otomicroscopy, the position and morphology of the tympanic membrane and the presence of liquid or gas bubbles in the middle ear were compared before and after the treatment. The tympanometric equipment used was a Grason-Stadler GSI 33, Version 2 Middle-Ear Analyser, with a probe frequency of 226 Hz. An improvement (but not normalisation) in the tympanometric findings was defined as the number of ears converting from a type B to a type C2 tympanogram. Normalisation was defined as conversion from a type B or C2 to a type C1 or A tympanogram<sup>70,71</sup>. Pure tone audiometry was performed in all children, except for those that would not collaborate in the performance of this examination. These children performed sound field audiometry instead. The pure tone average of the frequencies 500, 1.000 and 2.000 Hz were measured for the left and right ears in each child and the value for the best ear is presented in the results. When sound field audiometry was performed, the achieved values were assumed to represent the best hearing ear. All presented thresholds are in decibel hearing level and are abbreviated to dB. The examinations were performed in an approved audiometric test booth, provided by CA Tegnér AB, Sweden.

## Results

In paper 1, the pressure necessary to ventilate the middle ear was determined to be 40-60 cm H<sub>2</sub>O in most children. Thirty-one children (62 ears), with persistent bilateral OME for at least three months, were divided into a treatment and a control group. In the treatment group the middle ear pressure was normalized in 52% and improved in 31% of the ears whilst in the control group the middle ear pressure was normalized in 15%, improved in 15% and deteriorated in 10% of the ears ( $p < 0.001$ ).

In paper 2, 45 children, with persistent OME with a bilateral type B or C2 tympanogram for at least three months and history of subjective hearing loss, awaiting grommet surgery, were randomised to a treatment and a control group. In the treatment group the mean middle-ear pressure for both ears and the mean hearing thresholds for the best ear improved by 166 daPa ( $p < 0.0001$ ) and -6 dB ( $p < 0.0001$ ) respectively after four weeks, while, in the control group, non-significant alterations were observed. After the cross-over of the control group to treatment, equivalent improvements in the mean middle-ear pressure and the mean hearing thresholds of respectively 187 daPa ( $p < 0.0001$ ) and -7 dB ( $p < 0.01$ ) were achieved also in this group. After treatment in both groups at eight weeks, four of 45 children were submitted to grommet surgery. At the end of the study at 12 months, 36 children (80%) had not been operated with grommets.

In both studies all children managed to perform the manoeuvre and no side effects were neither reported nor detected.

## **Discussion**

In paper 1, a new device for autoinflation was developed to enable a combination of the Politzer and the Valsalva manoeuvres. The child could inflate the balloon to produce a modified Valsalva and by activating the pump a modified Politzer effect could be achieved. The balloon functioned as pressure regulator and reservoir to maintain the high pressure in addition to providing visual feedback. Covering the pump with a teddy bear most probably improved compliance. The results in this pilot study were suggestive of middle ear ventilation in children with persistent OME.

In paper 2 an effort was made to respond to some of the demands in the recent Cochrane report<sup>9</sup>. All children were evaluated by otomicroscopy, tympanometry and audiometry with a treatment time of four weeks in each group and a total follow-up time of 12 months. The device seemed to improve both middle-ear pressure and hearing thresholds in most children after four weeks of treatment. The device was well tolerated, even in young children, with no complications reported.

## **Conclusions**

A new device for autoinflation was developed and tested. The device seemed to be efficient in ventilating the middle ear in most children with persistent OME. The combined Valsalva-Politzer manoeuvre seems to have a beneficial effect on treatment outcome and compliance in young children. The presentation of the treatment as a toy most probably improved the compliance. Future studies are needed to confirm these results. However, due to the non-invasive character, it might be possible to consider this method of autoinflation in children with persistent OME during the watchful waiting period.

## **Future perspectives**

Future studies should have as objective to include a larger sample size in a multi-centre setting. This method of autoinflation should be compared with grommets and watchful waiting with respect to middle ear pressure, hearing threshold and quality of life. A comparative study of the socioeconomic aspects of the different treatment options would be of interest.

# **OBSTRUCTIVE SLEEP APNOEA**



## HISTORICAL BACKGROUND

Sleep is a vital biological function that comprises approximately 1/3 of the life of the human being. Mysteries regarding sleep and dreams have played a central role in the history of the mankind. One of the first descriptions of snoring as a medical condition during sleep, is from the 11<sup>th</sup> century in *The Canon of Medicine* by the Persian physician Avicenna (980-1037). Avicenna recognized snoring as a condition related to airway obstruction and suggested treatment options based on herbal therapy<sup>89</sup>. *The Canon of Medicine* was a standard medical text at medieval universities in Europe many centuries after Avicenna's death.

The description of electrical potential changes in the brain by Richard Caton (1842-1926)<sup>90</sup>, and the recording of the cortical electrical activity from the scalp, later known as electroencephalogram (EEG), by Johannes Berger (1873-1941)<sup>91</sup> were important steps in neurology and sleep research. Rechtschaffen and Kales standardized the criteria for staging sleep with polysomnography in 1968<sup>92</sup>.

The most cited literary description of snoring and sleep apnoea is probably by Charles Dickens (1812-1870) in the *Posthumous Papers of the Pickwick Club*<sup>93</sup>. Dickens described a fat boy called Joe who was a habitual snorer and suffered from somnolence. The term *Pickwickian* was coined by Heath in the late 19<sup>th</sup> century during a clinical presentation to describe overweight and breathing difficulties during sleep<sup>94</sup>. In the 1960's, two research groups, Gastaut et al. and Jung et al. published the first papers regarding sleep apnoea<sup>95</sup>.

It was not until late 20<sup>th</sup> century that snoring and OSA were considered as serious medical conditions in need of therapy. Many medical and surgical options along with a variety of technical devices for treatment of sleep apnoea have been presented; many of them with variable treatment outcome due to lack of efficiency, poor compliance or due to their invasive and non-tolerable character.

In early 20<sup>th</sup> century, Pierre Robin designed an external mandibular advancement device to treat glossoptosis causing sleep apnoea in his own child and other children suffering from what later was to be known as the Pierre-Robin syndrome<sup>96</sup>. This method for the advancement of the mandible and the tongue was further developed during the 1980's by two research groups, Cartwright and Samuelson<sup>97</sup> and Soll and George<sup>98</sup> to the mandibular advancing device (MAD) also known as mandibular retaining devices or oral appliances.

Sullivan et. al. introduced the continuous positive airway pressure (CPAP) for treatment of sleep apnoea in 1981<sup>99</sup>, which has been acknowledged as the gold standard of treatment in sleep apnoea ever since. Also in 1981 a surgical method for treatment of OSA was introduced by Fujita et al.<sup>100</sup>. Uvulopalatopharyngoplasty (UPPP) was a popular treatment initially but is currently not recommended for treatment of OSA in many parts of the world<sup>1,2</sup>.

The history of positional therapy for snoring and sleep apnoea is probably as ancient as the history of the mankind. Nevertheless the observed symptom improvement when avoiding the supine position has had limited impact in the treatment plan for sleep apnoea patients<sup>101</sup>.



## DEFINITIONS

### Snoring and upper airway resistance syndrome

Obstructive sleep apnoea (OSA) is caused by the collapse of the pharyngeal airway and is characterized by repetitive reduction (hypopnoea) or cessation (apnoea) of respiration during sleep despite respiratory effort<sup>24</sup>. The disease is of multifactorial aetiology and comprises a combination of airway anatomy interacting with physiological and habitual mechanisms causing the airway collapse<sup>102</sup>.

The physiological process of “narrowing” of the airway is gradual and might not always lead to OSA. (Figure 6) Snoring is a result of partial airway reduction and concomitant increase in air passage through a narrow airway resulting in vibration of the soft tissue<sup>103</sup>. The term upper airway resistance syndrome (UARS) is used when the narrowing of the airways and the increased resistance causes an elevated respiratory effort, leading to repetitive awakenings, i.e. arousals<sup>104</sup>. This condition does not cause apnoea, hypopnoea nor desaturation, nevertheless the sleep quality is reduced and the patient may present symptoms as in OSAS<sup>104</sup>. UARS may be difficult to diagnose and would primarily demand a polysomnographic evaluation for correct diagnosis.

### Snoring -> UARS -> Hypopnea-> Apnoea

**Figure 6**

*The progressive airway obstruction from snoring to apnoea.*

### Obstructive sleep apnoea

The pathological mechanism for OSA is believed to be the same as for snoring and UARS but the condition is more severe and include at least five or more apnoeas or hypopnoeas per hour, i.e. apnoea-hypopnoea index (AHI). The AHI is probably the most useful and objective way of classification the severity of OSA. The number of apnoeas and hypopnoeas per hour, i.e. apnoea-hypopnoea index (AHI), defines the severity of OSA. The classification by AHI has three levels; mild (AHI 5-14), moderate (AHI 15-30) and severe (AHI >30)<sup>24</sup>.

The definition of OSA and OSAS has changed over the years. The term obstructive sleep apnoea syndrome (OSAS) has traditionally been applied for a clinical entity defined by OSA with an AHI  $\geq 5$  in conjunction with hypersomnolence or related symptoms in the daytime function<sup>105</sup>. However the definitions have been altered during the past years. According to recommendations from the American Association of Sleep Medicine (AASM 2005)<sup>106</sup>, OSA is defined by the occurrence of daytime sleepiness, loud snoring, witnessed breathing interruptions, or awakenings due to gasping or choking in the presence of AHI  $\geq 5$ . AHI  $\geq 15$  in the absence of sleep related symptoms is also sufficient for the diagnosis of OSA due to the greater association of severity of obstruction with increased cardiovascular disease risk.

## **EPIDEMIOLOGY AND COMORBIDITY**

### **Prevalence**

The acknowledged prevalence of OSA and OSAS depend on the variables in the population sample and also the definitions applied. The prevalence in OSAS is reported to be approximately 2% in females and 4% in males<sup>23</sup>.

### **Age**

The tendency for development of OSA and the severity increase with age. Durán and co-workers found that in the age category, 30-70 years, the prevalence increases with an odds ratio of 2,2 for each 10 years<sup>107</sup>. Similarly Young et al. reported that the proportion of people with an AHI > 15 is higher in older subjects compared to younger subjects<sup>108</sup>.

### **Gender**

The reported male to female ratio for OSA is approximately 2:1<sup>23</sup>. In two studies comparing snoring and AHI between middle-aged men and women, Ferini-Strambi and co-workers, showed that 7% of the females and 8% of the men snored more than 50% of the night<sup>109,110</sup>. The percentage of subjects with an AHI >10 was 9% for females and 16% for men. In a retrospective review of 830 OSA patients, O'Connor et al. showed that OSA occurred predominantly during REM-sleep in women and that OSA in the supine position was more common in men<sup>111</sup>.

### **Obesity**

Obesity is recognized as a contributing factor on the severity of OSA<sup>112</sup> with a 10% increase in weight comprising a 6-fold greater risk of developing OSA<sup>112,113</sup>. The augmentation of fat around the neck, reducing the airway size, along with several central effects of obesity are believed to provoke or deteriorate OSA<sup>114</sup>. The estimates in men and women with a body mass index from 25-28 shows that roughly one of five adults have at least mild level of OSA and one of 15 has at least moderate level<sup>107</sup>.

### **Cardiovascular disease**

Cardiovascular disease is the most important OSA-related morbidity<sup>108,113,115,116</sup>. Sympathetic hyperactivity and imbalance of vasoactive hormones are believed to cause OSA-related hypoxia, hypercapnia and hypertension, which predispose to cardiovascular diseases<sup>117-120</sup>. The severity of OSA is also reported to correlate with an increased insulin resistance<sup>121,122</sup>.

Subjects with moderate or severe OSA have about three times the adjusted odds of developing hypertension compared with persons without OSA<sup>123</sup>. OSA seems to be particularly common in patients with resistant hypertension; some studies indicate an OSA prevalence of 83% in patients with resistant hypertension, defined as poorly controlled hypertension despite the use of three or more antihypertensive agents<sup>124</sup>. Screening for hypertension is recommended in OSA patients<sup>125,126</sup>.

Several studies indicate a high OSA prevalence (43%-72%) in patients with stroke<sup>127,128</sup>. The Wisconsin Sleep Cohort Study with 18 years of follow-up showed an increased hazard ratio (HR:3.0) for all-cause mortality and also cardiovascular-related mortality (HR:5.2) in OSA-patients after adjusting for potential confounders<sup>26</sup>. Similar findings were reported also by Marshall et al.<sup>25</sup> and Marin et al.<sup>129</sup>.

## **PATHOPHYSIOLOGY**

The maintenance of open airways during sleep is the result of the co-function of several anatomical and physiological factors<sup>102</sup>. Alteration in these stabilizing factors might lead to dynamic changes that would potentially provoke the development of OSA. Some anatomical, physiological, hormonal and habitual factors have been recognized but it has not been possible to point out one single factor responsible for the development OSA indicating that the disease is of multifactorial aetiology<sup>102</sup>.

The tendency of apnoea is in general higher in REM (Rapid Eye Movement) than non-REM sleep due to the concomitant muscle relaxation in the previous one, nevertheless, subjects suffering from OSA show the tendency to airway collapse also in non-REM sleep<sup>130</sup>. The size of the airway is dependent on the respiratory cycle. The cross section area increases during early inspiration and decreases during the end of expiration<sup>102</sup>. In OSA subjects a progressive cumulative narrowing occurs after each respiratory cycle, causing a partial or complete airway obstruction<sup>102,131</sup>.

Studying the upper airway physiology and anatomy helps us to understand the pathological mechanisms causing OSA. The possible effect of certain treatment options described in the literature as controversially may be illuminated by the basic knowledge in the airway physiology. For instance enlargement surgery of the nasal cavity has been proposed for the treatment of OSA but with observed positive and negative effect on the severity of disease<sup>132-134</sup>, which will be further discussed here below.

### **Airway anatomy**

Several anatomical features may contribute to the development of OSA. The most important anatomical factor in the severity of OSA is the pharyngeal soft tissue and the tongue. The tongue is larger and the soft palate is both longer and wider in OSA patients compared with healthy individuals<sup>135</sup>. Associated craniofacial variables include also a long mandibulo-hyoid distance adeno-tonsillar hypertrophy and nasal obstruction, however mandibular and especially maxillary retrognathia seem to be the most important factors for the development of OSA in non-obese subjects<sup>133,136</sup>.

## Airway physiology

The act of inspiration is possible due to intraluminal (airway) negative pressure produced by the respiratory muscles. This negative pressure may potentially cause a narrowing or collapse of the flexible airways. A so-called balance of forces model describes the counteracting variables influencing the airway size and patency<sup>102</sup>. These variables may produce both dilatation and collapse in the upper airways.

Dilating forces include upper airway muscle tone, tissue elasticity of the airway wall structure and positive intraluminal airway pressure<sup>102</sup>. Collapsing forces include pharyngeal tissue mass, surface adhesive forces and negative intraluminal pressure produced by inspiration<sup>102</sup>. These forces act on the airway walls and the resulting difference determines the upper airway size.

The physiological model of the airways is described by three principle forces interacting to determine the supraglottic airway size at sleep, i.e. Bernoulli, Starling pressure forces, and gravity<sup>102,137</sup>. The forces act synergistically to cause or deteriorate the severity of sleep apnoea and are always present to some extent. The impact of these forces is maximized when the muscle tone is at a minimum level, hence typically in REM-sleep. To understand the impact of these forces a soft and collapsible tube could be used as a model for the upper airways (Figure 7).

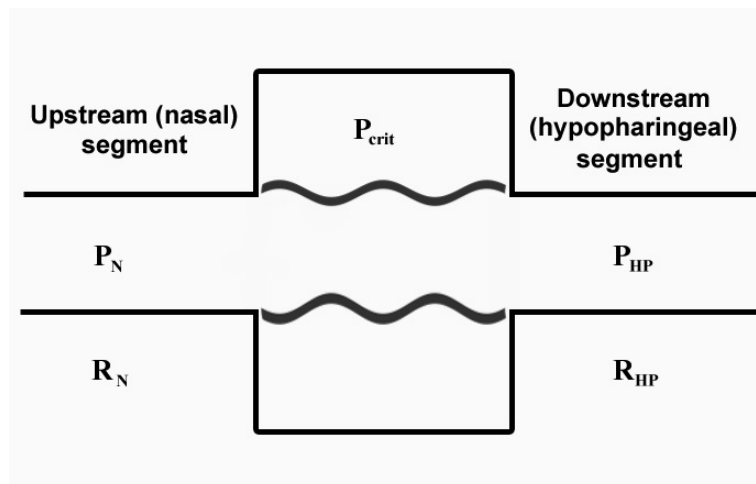

**Figure 7**

*In the Starling resistor model, the upper airway is represented as a tube with a collapsible segment. The nasal and the hypopharyngeal segments have fixed resistances ( $R_N$  and  $R_{HP}$ ) and intraluminal pressures ( $P_N$  and  $P_{HP}$ ), respectively. Collapse in the middle section occurs at a critical pressure ( $P_{crit}$ ) when the pressure surrounding the airway becomes greater than pressure within the airway. (Image modified from Woodson 2007)*

The act of inspiration causes a negative pressure in the airways. Using the collapsible tube in the Starling resistor model, the effect of the negative intraluminal pressure on the collapsible pharyngeal airways becomes clear. The higher the negative pressure within the system, hence either negative pressure produced by the respiratory muscles

or suprapharyngeal obstruction, the greater the negative intraluminal pressure that may collapse the pharynx<sup>102</sup>(Figure 7).

One of the basic laws of physics in aviation, Bernoulli, explains how the soft tissue may collapse with the rapid passage of air through pharynx. Bernoulli's principle states that with reduced diameter, an increase in air velocity occurs simultaneously with a decrease in pressure<sup>137</sup>. The smaller the transverse diameter of the tube, the higher the speed of the air, the lower the intramural pressure hence the greater tendency of collapse<sup>138</sup>(Figure 8).

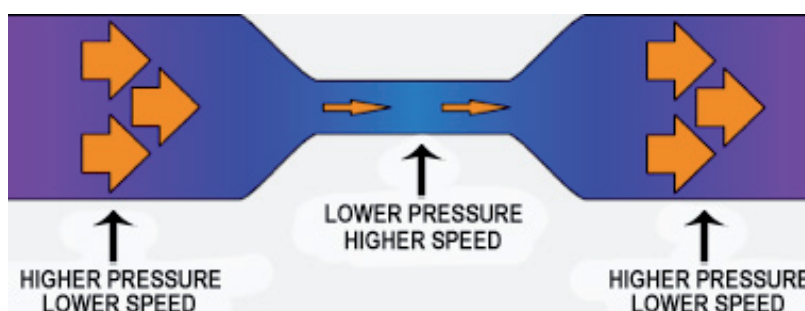

**Figure 8**

*The Bernoulli principle states high intraluminal pressure with low velocity in the segments of the tube with large diameter and higher speed and lower pressure in the middle section with small diameter.*

The Starling resistor model and the Bernoulli may illuminate the theoretical background of the disease but the uncertainty of the actual dominating physical force in each individual is a clinical dilemma. For instance enlargement surgery of the nasal cavity is not a recommended treatment option for OSA due to controversial effect observed in the clinical trials<sup>132-134</sup>. According to the theoretical model presented in cases where the starling resistor is the dominant collapsing force, enlargement surgery of the nasal cavity might help reducing the airway collapse (Figure 7). On the other hand when the effect of Bernoulli is the dominating cause of obstruction any surgical attempts of enlarging the space above the level of pharynx may lead to more air entering and passing through a tight hypopharynx, producing higher air speed, lower pressure and theoretically more tendency of airway collapse<sup>139</sup> (Figure 8).

The third and probably the most important physical force, influencing the upper airways, was first described by Sir Isaac Newton (1642-1727) observing an apple falling from a tree. The gravity produces its greatest vector on the tongue when lying on the back in the supine position<sup>140</sup>. When the sleeping position is altered to the side this vector is reduced<sup>141</sup>. The exploration of an altered gravity vector has been one of the bases of this thesis.

## **Snore induced mechanical damage & gastro-oesophageal reflux disease**

In a healthy individual, counter-acting neuromuscular forces sustain the patency of the airways. The dilator muscles are activated by mechanoreceptors to respond to the inspiratory negative pressure<sup>142</sup>. Apnoea and snoring may cause a mechanical trauma leading to oedema and damage to both musculature and motor sensor neurons<sup>143,144</sup>. The mechanical damage causes an impairment of the normal neuromuscular function, which may reduce the dilator function and compromise the stability in the airways during sleep<sup>143,144</sup>. In a similar way Gastro-oesophageal reflux disease (GERD) may play a role in the development of OSA by causing upper airway inflammation and tissue damage. Some trials have shown that proton pump inhibitors may improve the severity of OSA<sup>145,146</sup>.

## **DIAGNOSTIC MEASUREMENTS AND METHODS**

Many different symptoms are associated with OSA. The correct diagnosis of disease is dependant on the combination of clinical history and examination together with supplementary examinations. Questionnaires and functional tests are also used for the evaluation of excessive daytime sleepiness (EDS). There are disadvantages related to all types of tests. The objective tests are normally more complicated to perform and time consuming. Questionnaires are sensitive to recall bias, motivation, degree of education, fatigue and personality<sup>147</sup>. Some of the most common examinations and tests are referred to here below.

### **Sleep study**

The term polysomnography (PSG) refers to the monitoring and recording of multiple sleep-related signals. PSG records simultaneously neurophysiological, cardiopulmonary and other physiological parameters over the course of several hours<sup>148</sup>.

By PSG the following sleep stages can be identified: non-Rapid Eye Movement (non-REM) 1,2 and 3 (N1, N2 and N3 respectively) and stage REM (R)<sup>24</sup>. The most important electrodes for sleep staging are the EEG, electro-oculogram (EOG), and chin electromyogram (EMG). The EEG wave-form along with registration of muscle activity helps in identifying the different stages. The REM-sleep is known to have a significant effect on the severity of OSA, with greater length of apnoeas, greater hypoxaemia and greater hypercapnia<sup>130</sup>.

PSG is recognized as the gold standard for diagnosis of OSA<sup>148</sup> (Figure 9). A gold standard in diagnostic should have 100% sensitivity and specificity<sup>149</sup>. Like many other diagnostic methods PSG does not have this level of reliability for OSA diagnostics, but it is considered the best available diagnostic method.



Due to the large number of patients referred to the sleep laboratory and the practical difficulties related to PSG-monitoring, a continuous effort has been done to develop simpler diagnostic devices. One of the most used devices for this purpose is the polygraphy equipment (PG).



**Figure 9**  
*Subject prepared for multi-channel PSG sleep study.*

Four types of sleep studies are available depending on the number of physiological variables recorded<sup>148</sup>.

Level I: Standard PSG with a minimum of seven parameters measured, monitoring both sleep and cardiorespiratory functions including EEG, EOG, chin EMG, electrocardiogram (ECG) as well as respiratory parameters (airflow, respiratory effort and oxygen saturation), body position and video monitoring (a technician is in constant attendance).

Level II: A portable PSG where the examination is basically the same as level I with the exception of heart rate replacing the ECG and the technician not being at constant attendance (applied in papers III and IV).

Level III: PG-studies with the measurement of a minimum of four parameters including ventilation (at least two channels of respiratory movement, or alternatively airflow and respiratory movement), heart rate or ECG and oxygen saturation. (Applied in paper III)

Level IV: Continuous recording of at least one parameter, usually oxygen saturation

Current recommendations provided by the Swedish SBU confirm that manually scored portable devices (level III) monitoring airflow, respiratory effort and blood oxygen saturation have sufficiently high sensitivity and specificity to identify and classify OSA<sup>150</sup>. Recent studies also confirm the high correlation between AHI achieved in PSG and PG<sup>151,152</sup>. However the objective sleep time and arousals cannot be assessed with PG.

#### *Positional sleep apnoea & night-to-night variability*

The number and duration of respiratory disturbances in patients with OSA depend on body position and sleep stage<sup>141</sup>. In an early study, Gastaut et al. described the aggravating effect of the supine position on OSA<sup>153</sup>. The lateral position is believed to reduce the tendency for the tongue to fall backward, making the collapse of the pharynx less likely, as compared with the supine position. Cartwright et al. suggested a categorization of the patients suffering from OSA into positional and non-positional based on the supine and lateral sleep time<sup>141</sup>. The patients with positional obstructive sleep apnoea (POSA) were recognized as having twice as many apnoeas in the supine position compared with the lateral positions<sup>141</sup>.

According to the SBU report, the result of AHI of two different nights are relatively similar, however several studies claim the contrary<sup>154,155</sup>. The traditional classification based on AHI does not take into account the position of the body, the head nor the acknowledged night-to-night variability in the respiratory parameters<sup>154,156,157</sup>.

## **Questionnaires**

Symptoms related to daytime sleepiness often accompany the OSA(S) patient. In addition to a thorough medical history, including evaluation of other somatic and psychiatric disorders, as well as habitual and medical factors, the evaluation is often complemented by questionnaires. Unfortunately there is often a discrepancy between the objective signs for the severity of disease and the symptoms reported by the OSA-patient<sup>7,150,158</sup>. The questionnaires are therefore unreliable for the diagnostic of OSA and are primarily used to map out the associated symptoms.

The most validated and used questionnaire for the evaluation of excessive daytime sleepiness (EDS) is the Epworth sleepiness scale (ESS)<sup>159</sup> (Figure 10). This is a self-administered questionnaire on the subjective likelihood to fall asleep in eight different common daily situations. The eight questions are rated by a four-point scale (0-3) with a total score of 24, with the probability of mild sleepiness with a score of 8-10, moderate with a score of 11-14, severe with a score of 16-20 and excessive with a score of 21-24<sup>159</sup>. Other questionnaires include the Stanford sleepiness scale, the Karolinska sleepiness Scale and Quality of Life questionnaires.



**Epworth Sleepiness Scale**

How likely are you to doze off or fall asleep in the following situations?  
Answer considering how you have felt over the past week or so.

0 = Would never doze  
1 = Slight chance of dozing  
2 = Moderate chance of dozing  
3 = High chance of dozing

1. Sitting and reading	<input style="width: 100%; height: 20px;" type="text"/>
2. Watching TV	<input style="width: 100%; height: 20px;" type="text"/>
3. Sitting inactive in a public place (e.g., theater or meeting)	<input style="width: 100%; height: 20px;" type="text"/>
4. As a passenger in a car for an hour without a break	<input style="width: 100%; height: 20px;" type="text"/>
5. Lying down to rest in the afternoon when able	<input style="width: 100%; height: 20px;" type="text"/>
6. Sitting and talking to someone	<input style="width: 100%; height: 20px;" type="text"/>
7. Sitting quietly after a lunch without alcohol	<input style="width: 100%; height: 20px;" type="text"/>
8. In a car while stopped for a few minutes in traffic	<input style="width: 100%; height: 20px;" type="text"/>

**Figure 10**  
*Epworth Sleepiness Scale (ESS)*

The evaluation of EDS through objective testing is normally time consuming and not available at all sleep laboratories. Such tests include the multiple sleep latency test (MLST), maintenance of wakefulness (MWT) and the OSLER test. Unfortunately the results of the questionnaires and objective testing may be poorly correlated to each other<sup>160</sup>.

### **Other examinations**

Studies such as Mallampati classification modified by Friedman, lateral cephalometry, computer tomography (CT), magnetic resonance imaging (MRI) and flexible nasal endoscopy of the upper airways have been used for classification and diagnosis of OSA and also detection of the level of obstruction<sup>161,162</sup>. An important limitation in all these methods is that they are generally conducted in an awoken patient giving a limited comprehension of the pathology during sleep.

## TREATMENT OPTIONS

### Lifestyle

A thorough medical history and clinical examination should map out and reduce the predisposing factors such as obesity, consumption of tobacco, alcohol and sedatives. Weight loss together with life style changes should be considered as treatment in all patients with OSA<sup>2,150</sup>.

### Continuous Positive Airway Pressure

Since Sullivan et. al. introduced the continuous positive airway pressure (CPAP) in 1981<sup>99</sup>, it has become the first line of treatment for OSA patients<sup>2</sup>. The equipment functions as a pneumatic splint preventing the upper airway from collapsing during sleep.

Considering the balance of forces previously described, CPAP seems to influence the Starling pressure forces by reducing the negative intraluminal inspiratory pressure and in fact producing a positive pressure by forcing the air into the airways. The negative pressure in the Bernoulli formula is also reduced due to prevention of decrease in the transversal diameter and subsequent reduction in air speed.

For adherents to treatment, polysomnographic outcomes, the mean values for AHI, oxygen saturation and sleep fragmentation favour CPAP in most studies<sup>2,150,163,164</sup>. CPAP is indeed efficient in treating OSA independent of the level of obstruction with objective improvements in sleep quality, oxygen saturation during sleep, cognitive performance, daytime alertness and also control of systemic hypertension and reduction of cardiovascular mortality<sup>26,165,166</sup>.

The long-term compliance with CPAP is dependent on side effects and patient motivation<sup>7,167,168</sup>. For the CPAP-users 100% compliance has been defined as 20 hours of usage per week, meaning at least four hours of usage in five of seven days in a week<sup>167</sup>. Some studies indicate a median compliance of approximately 50-68% after one to four years<sup>4,6</sup> and that many patients are non-adherent to CPAP treatment > four hours per night<sup>7</sup>.

### Mandibular Advancement Device

Mandibular Advancement Device (MAD) is recommended as the second line of treatment for patients with OSA<sup>2,150</sup> and is primarily indicated in patients with snoring, UARS and also mild to moderate OSA without known cardiovascular disease.

MAD acts by pulling forward the mandible and the soft tissue creating an increase in the volume of the pharyngeal airway as well as increasing airway stability<sup>169,170</sup>. This effect is similar to the genioglossus muscle function in reducing the tendency of the

tongue to fall backwards<sup>171</sup> hence reducing both the Starling and the Bernoulli effect in collapsing the hypopharynx

Even though MAD has been found to have a positive long-term impact on several OSA symptoms such as daytime sleepiness, morning headache and daytime naps in compliant patients<sup>172</sup>, it has shown to be less effective than CPAP in reducing both excessive daytime sleepiness and AHI<sup>150</sup>. POSA seems to be positive predictor for MAD treatment efficiency<sup>173,174</sup>

## **Surgery**

Fujita introduced the uvulopalatopharyngoplasty (UPPP) in 1981 as a surgical treatment for OSA<sup>100</sup>. UPPP comprises a reduction of the palatal and pharyngeal redundancy by tonsillectomy and resection of excess mucosal and submucosal tissue in the pharyngeal area.

Initially the technique was considered a great success but later, Sher and co-workers reported only 40% success rate in achieving long-term cure<sup>175</sup>. In fact, some studies have described patients, who have worsened after UPPP both objectively observed by PSG, and subjectively by increased daytime sleepiness<sup>176</sup>.

This surgical procedure is not recommended in many parts of the world due to unreliable results and complications associated with the surgical procedure<sup>2,150,177</sup>. A recent thesis by Browaldh in the evaluation of surgical methods shows possible improvement of the results applying specific models for selection of the surgical candidates<sup>178</sup>.

Two efficient surgical options in the treatment of OSA are maxillomandibular advancement (MMA) and tracheostomy. Both methods have shown promising short- and long-term results in cohort studies<sup>179,180</sup>. However, due to the invasive character of these surgical technique they are not applied as common treatment options for OSA.

## **Positional Therapy**

The lateral position is believed to reduce the tendency for the tongue to relapse posteriorly, making collapse of the pharynx less likely, as compared with the supine position. Approximately 50% of the patients with OSA have a reduction  $\geq 50\%$  and 30% of the patients a reduction of  $< 50\%$  in the apnoea-hypopnoea index (AHI) when altering the sleep position from the supine to the non-supine positions<sup>181-185</sup>. The change in the severity of disease due to the sleep position has been observed but the studies have mainly been performed on the supine and lateral positions<sup>101</sup>.

Simple behavioural treatment modalities, designed to maintain a non-supine body position at night, have been effective in treating many patients with positional OSA. One of the first described therapies to reduce snoring and to improve OSA is the so-called “tennis ball technique”. A tennis ball is sewn into the pyjamas or fastened by a belt to the back of the patient in order to reduce the time spent in the supine

position<sup>186</sup>. This treatment has been shown to reduce the supine time and to improve AHI in patients with POSA<sup>186,187</sup>. Inspired by the tennis ball technique, several other positional methods have been developed primarily to reduce the time spent in the supine position and to increase the time spent in the lateral positions<sup>188,189</sup>.

Regardless of the simplicity and potential efficiency in about 80% of the OSA-patients the clinical impact of positional therapy has been limited<sup>101</sup>. With the exception of a few case reports<sup>190-192</sup>, there is limited experience regarding the effect of prone positioning on the severity of disease in adults with OSA, which has been the proposed treatment option in this thesis.

## BACKGROUND OF THE HYPOTHESIS

One central questions in this thesis was to determine why the human body is so vulnerable and exposed to repetitive collapse of the airways during sleep. In the animal kingdom sleep apnoea seems to be a rare phenomena. With the exception of few recognized species most animals seem to avoid apnoeas during sleep. Indeed human being is one of the few mammals preferring the supine sleeping position and also one of the few vertebrates with observed sleep apnoea.



**Figure 11**  
*Animals sleeping.*

The gravity is considered to contribute to the collapse of the airways at the level of hypopharynx by pulling the soft tissue towards the posterior pharyngeal wall in the supine position<sup>102</sup>. The lateral position has proven to reduce the tendency of airway collapse and severity in disease in patients with OSA. Considering the observed improvement in the lateral positions, the prone position should have an additional effect by reversing the gravity and pulling the soft tissue towards the mouth, hence producing a larger trans-sectional area in the pharynx.

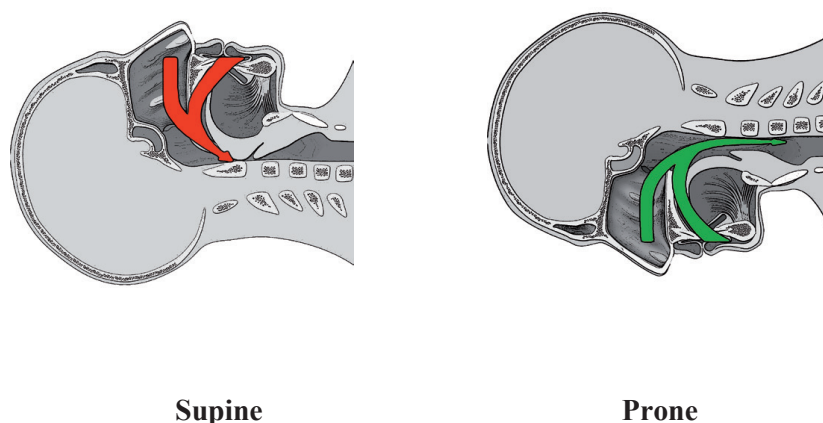

**Figure 12**  
*The hypothetical alteration of airway size with altered gravity vector from the supine to the prone position.*

Recalling the 3 principle forces influencing the patency of the pharyngeal airways, sleeping in the prone position should theoretically:

1. Reverse the negative effect of the gravity at the level of the hypopharynx, pulling forward the lower jaw and the soft tissue, hence producing a larger trans-sectional area and reducing the tendency for airway collapse.
2. Increase the trans-sectional area in the pharynx, which reduces the velocity of the inspiratory air, hence reducing the negative intraluminal pressure in the Bernoulli equation.
3. Stabilize the pharyngeal airways by pulling the soft tissue forward and hence counteracting the collapsing mechanism described in the Starling resistor model.

The idea of prone positioning in the treatment of OSA arose from this theoretical background. Nevertheless the present thesis focused on the clinical outcome of this proposed treatment and not the study of the physiological mechanisms.

## **HYPOTHESIS AND AIMS**

The principal aim of this part of the thesis was to develop and study the compliance and effect of a new mattress and pillow facilitating prone positioning on severity of disease in adults with OSA. A summary of the major research hypothesis is presented below.

### **What are the important factors in the development of OSA?**

The question of why the human being has been “cursed” with sleep apnoea and not many other vertebrates has been raised before. A literature study was conducted to identify different anatomical, physiological, hormonal and habitual factors deteriorating and/or improving the severity of sleep apnoea. Gravity and sleeping in the supine position were identified as two important factors.

### **What is the effect of the prone body and head position on the severity of disease in patients with OSA?**

Previous studies have evaluated the effect of the body position in the severity of disease in patients with OSA. Nevertheless, the studies have mostly been limited to the supine and the lateral positions. Our theoretical studies of the airway physiology suggest that the prone body and head position may reverse the gravity vector and diminish the tendency of airway collapse during sleep.

### **How can we make it possible for the patient to sleep in the prone body and head position in a normal bed?**

Traditional beds are primarily designed to sleep in the supine and to lesser extent also in the lateral positions. However it is difficult to sleep in the prone head position during a longer time in a normal bed. One of the goals of the present thesis was to create a new mattress and pillow to facilitate prone positioning.

### **What is the short versus long-term effects of prone positioning in patients with OSA?**

The experience regarding the prone sleeping position is limited. The effect on the respiratory parameters, sleep architecture, tolerability and possible side effects were evaluated in this thesis.



## ***PAPER SUMMARIES 3 & 4***

This chapter will primarily deal with the general aspects of the applied methodology and the achieved results in the papers. Some of the most important steps in the development of the mattress and pillow will be discussed. For the detailed protocol and the specific results for each experiment, the reader is referred to the respective manuscript.

### **Materials and methods**

#### *A new mattress and pillow for prone positioning*

A true prone sleep position was defined as a prone body and head position with the nose mostly perpendicular to the underlying surface. For this purpose a mattress and a pillow facilitating prone positioning were designed and created.

The main purpose of the mattress and pillow for prone positioning (MPP) was to provide a comfortable sleep position that would make it possible for the patient to lie with his/her body and head in the prone position most of the night. The MPP should be compatible with a bed to avoid the practical problem of changing the whole bed for the purpose of the study. The pillow should provide sufficient support for comfortable prone positioning of the head and at the same time allow for air exchange to maintain normal breathing without the sensation of heat or asphyxiation. During the course of this thesis approximately 40 different models for mattress and pillow were developed and clinically tested.

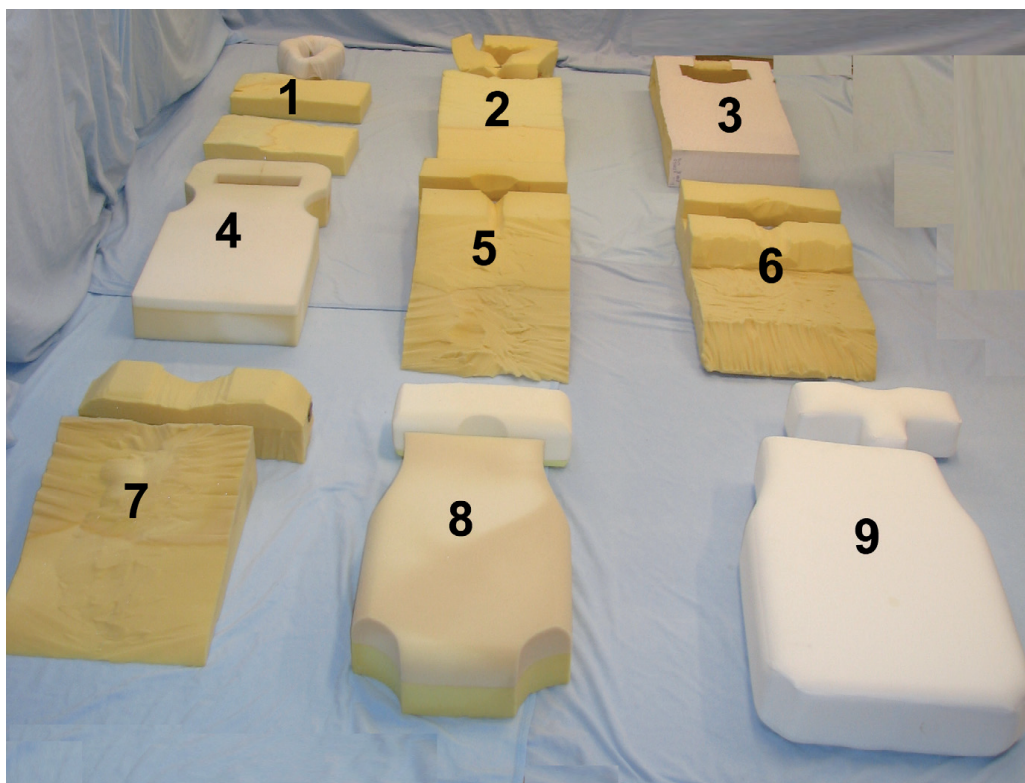

**Figure 13**

*December 2008, the author during the process of development and testing.*

Several prototypes consisting only of a pillow were tested. Due to the necessary elevation of the head in the prone position and the hyperextension in the neck it is was mandatory to also elevate the rest of the body. To achieve anatomical angles in the shoulders and hips, firm supports below the chest and the hip were necessary.

One of the first complete MPP models (Figure 14:1) consisted of a circular pillow with ventilation shunts for positioning of the head. The pillow would be combined with a set of supporting mattresses to be positioned beneath the chest and the hip of the patient. This mattress set provided a prone position similar to the position used in the operating theatre for spinal surgeries. However, prone positioning with the mattresses proved to be unstable during sleep making it probable for the patient to deviate from the desired position and the circular pillow did not permit sufficient air exchange during sleep.



**Figure 14**

*Some of the most important steps in the development of the mattress and pillow models.*

*Chronologically one of the first models from 2008 is on the top left and one of the last models from 2010 on the bottom right.*

Another important prototype consisted of a mattress with a wider space for air exchange assuming a rectangular shape with central and lateral air shunts providing improved ventilation and stability (Figure 14:3 and 14:4). The mattress was eventually inclined to elevate the upper body and provided a firm support under the



chest (Figure 14:5 and 14:6). Nevertheless air exchange and individual adaptation for the degree of extension and flexion in the neck was limited, producing heat in the face and in some cases neck pain.

As suggested by Raquel Silva, a division was made separating the head support from the body mattress (Figure 14:7 and 14:8). The result was improved ventilation and the possibility of individual adaptation regarding the firmness and height of the pillow relative to the mattress. The main problem with this set was the feeling of excessive pressure focused on the forehead, causing discomfort and deviation from the desired position during sleep.

A basically T-shaped pillow was then designed to allow for sufficient air exchange, support of the forehead and one side of the face, distributing the pressure over a larger area of the face, i.e. forehead and one of the cheeks with the option of supporting the chin on the mattress (Figure 14:9 and 15).

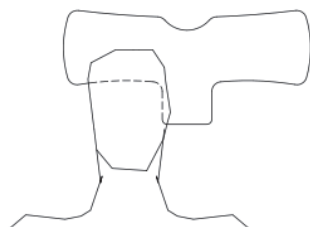

**Figure 15**

*The T-shaped pillow with the distribution of the pressure over a larger area of the face with preservation of space for air exchange.*

Another problem was the sensation of pressure and paraesthesia in the arms after sleeping in the desired prone position for some hours. The mattress was excavated on the top laterals to avoid pressure on the arms (Figure 14:8 and 14:9).

Some patients deviated from the desired position during the night. Several strap mechanisms for the head and the body were designed but abandoned due to possible discomfort and to avoid the sensation of being “trapped”. To improve comfort and adaptability according to body configuration and also to prolong the hours of sleep in the desired position, a visco-elastic (memory) foam was introduced and used. The material reacted to body heat, assuming the shape of the subject lying on the mattress and pillow, which permitted individual adaptation depending on the body shape. After lying on the mattress, the temperature sensitive visco-elastic material would transform the mattress into a mould of the body shape, which would help maintaining the desired position.

The final result consisted of a mattress and the T-shaped pillow to be positioned upon a normal bed in the desired orientation (Figure 16). As suggested by Hasse Ejnell the mattress was provided in different sizes for improved compliance and adjustability depending on the personal preferences of the subjects.

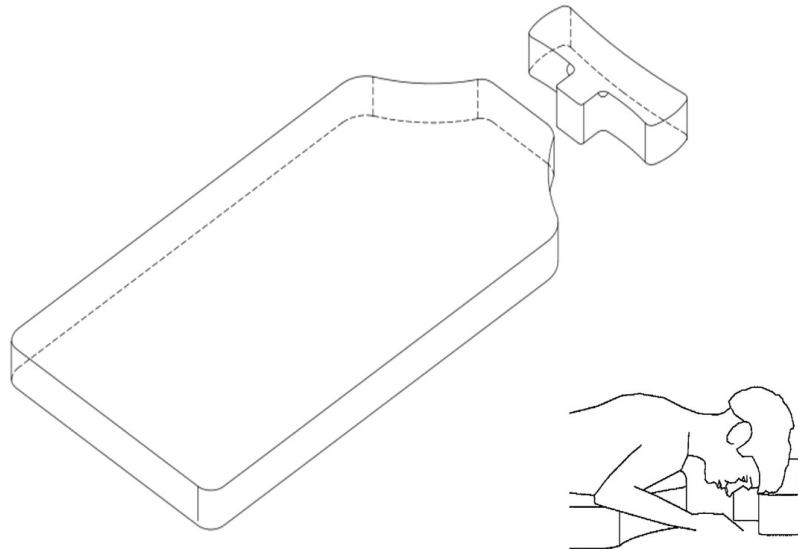

**Figure 16**

*The T-shaped pillow and the mattress with lateral excavations, which permitted comfortable positioning of the arms during sleep.*

The MPP provided also a comfortable lateral positioning with one side of the face resting on the pillow and comfortable positioning of the shoulder and the arm in the space between the mattress and the pillow, reducing undesirable body pressure on the upper extremity (Figure 17). However due to the design and the material of the MPP supine positioning would be difficult.

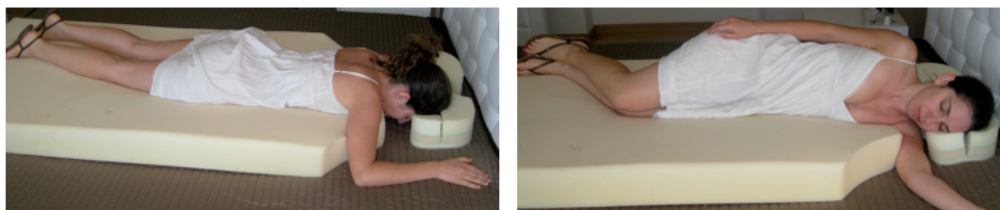

**Figure 17**

*Left: Subject in a prone body and head position with the nose mostly perpendicular to the underlying bed with anatomical angles in the shoulders and the elbows. Right: Lateral sleep position with comfortable placement of the shoulders and the arms.*

## Diagnostic methods

In paper 3, polygraphic (PG) and polysomnographic (PSG) equipments were used for sleep study. In paper 4 PSG sleep studies were performed.

## Results

In paper 3, in the 27 patients that completed the study protocol, the median AHI decreased from 23 to 7 ( $p<0.001$ ) and the median oxygen desaturation index (ODI) from 21 to 6 ( $p<0.001$ ) in the MPP. The median time spent in the supine position decreased from 142 to < 1 minutes ( $p<0,0001$ ) and the median time in the prone position increased from <1 to 330 minutes ( $p<0,0001$ ) with the MPP. In general, patients with POSA had greater effect of the treatment; nevertheless 42% of the patients with non-POSA were also responders. Overall sleep duration and sleep quality did not change.

In paper 4, in the 14 eligible patients, the mean AHI and ODI decreased from 26 and 21 to 8 and 7 respectively ( $p<0.001$ ) with the MPP. The mean total sleep time was 390 minutes during the first night and 370 minutes during the second night with the MPP ( $P=0.7$ ). The mean time spent in the supine position was reduced from 128 to 10 min ( $p=0.02$ ) and the prone time increased from 42 to 174 min ( $p=0.02$ ) with the MPP whilst the time spent in the lateral positions was similar. Mean SaO<sub>2</sub>-min increased from 80 (min:54;max:91) to 87% (min:78;max:93) ( $p<0.05$ ). All patients managed to sleep on the MPP > four hours per night during the four-week study.

## Discussion

Based on the acknowledged aggravating effect of the supine position on the severity of disease in patients with OSA, a new mattress and pillow for prone positioning were developed to theoretically reverse the gravity effect. Our observations indicate reduced airway collapse with improved AHI and ODI when sleeping in the prone position with the mattress and pillow as compared with both supine and lateral positions on a normal mattress.

The MPP seemed to reduce the time spent in the supine position and increased the time spent in the prone position. Significant reductions of AHI and ODI were observed in OSA patients but in particular in POSA patients. This was achieved by a reduction in the supine time and an increase in the prone sleep time with no observed disruption of sleep duration or sleep quality. In general POSA-patients seemed to have greater effect of the treatment. Compliance for the four-week study (paper 4) was satisfactory with all the patients completing the study with sleep time of  $\geq 4$  hours per night with the MPP.

A limitation in the methodology was the failure in monitoring of the position of the head in all the patients (paper 4). Another limitation was the short follow-up time, which makes it impossible to predict the long-term efficiency and compliance with the treatment.

## **Conclusions**

Human-being is one of the few recognised species with an acknowledged high prevalence of OSA. The prone sleep position seems to be a beneficial sleep position for patients suffering from OSA. This novel concept with the new mattress and pillow for prone positioning reveals promising results in treatment of OSA patients.

## **Future perspectives**

Future studies should assess the long-term compliance and efficiency of this method. The head position seems to have an important impact on the severity of OSA and monitoring of the body and head position should be included in sleep studies. Based on the feed-back of the patients several options for mattresses are necessary for personal adaptation. These alternatives should include different lengths and viscosities of the mattress.



## SUMMARY IN SWEDISH

Populärvetenskaplig sammanfattning

### **Två nya icke-kirurgiska behandlingsmetoder för öronkatarr hos barn och sömnapné hos vuxna**

Öronkatarr hos barn och sömnapné hos vuxna är två vanligt förekommande sjukdomar. Ett flertal kirurgiska och icke-kirurgiska metoder har utvecklats för behandling av dessa sjukdomar men flera av dem har otillräcklig följsamhet och/eller medicinsk effekt. Det övergripande syftet med denna avhandling var att utveckla och testa två nya icke-kirurgiska behandlingsmetoder för dessa sjukdomar.

#### *Öronkatarr*

Hörselnedsättning är det vanligast förekommande funktionshindret hos barn. Öronkatarr är den vanligaste orsaken till hörselnedsättning hos barn. Öronkatarr beror på undertryck och ansamling av vätska i mellanörat, vilken oftast uppstår efter en förkylning eller öroninflammation. I Sverige insjuknar årligen 400.000 barn i öronkatarr. Årligen opereras ca 10.000 barn, oftast i åldern 2-6 år, med plaströr. Denna kirurgiska behandling är den vanligaste operationen utförd under narkos på barn i hela världen.

En ny metod för tryckutjämning utvecklades och testades på barn i åldern 2-8 år med kvarstående öronkatarr uppsatta på väntelista för operation med plaströr. I vår första studie fann vi att den nya metoden var effektiv på ca 80% av barnen och att barn från 2 års ålder kunde använda behandlingen.

I en andra studie testades den nya metoden för tryckutjämning på 45 barn som stod på väntelistan för operation med plaströr. Efter 4 veckors behandling fann vi att trycket i mellanörat och hörseln förbättrats för de flesta barnen. Barnen följdes upp i totalt 12 månader och om ny öronkatarr uppstod, kunde behandlingen upprepas. Enbart 20% av barnen behövde opereras med plaströr under året, medan resten undvek operation.

## *Sömnapné*

Många människor snarkar och en del snarkare har även andningsuppehåll under sömnen. Andningsuppehåll under sömnen kallas sömnapné och gör att man får upprepade sänkningar av syremättnaden och en splittrad sömn. Sömnapné drabbar upptill 20% av befolkningen i medelåldern.

Effekten av kroppens läge på snarkning och sömnapné är känd sedan länge. Man vet att ryggläge är det sämsta sovläget för sömnapnoiker och snarkare och att upptill 80% av patienterna blir bättre av att ligga på sidan. Människan är ett av de få däggdjuren med känd sömnapné. Till skillnad från människan, sover de flesta djuren på magen.

I den tredje studien värderades effekten av magläge på sömnapné hos 32 patienter. För att kunna utföra studien, utvecklade vi en madrass och kudde som möjliggjorde att patienterna sov på magen. Antalet andningsuppehåll per timma sömn minskade i genomsnitt från 23 till 7 när patienterna sov på madrassen och kudden. Denna förbättring åstadkoms genom att sovtiden på rygg minskade kraftigt och sovtiden på magen ökade i motsvarande grad.

I den fjärde studien, värderade vi effekten av magläge på sömnapné samt möjligheten att sova på madrassen och kudden under 4 veckor. Samtliga 15 patienter klarade av att sova varje natt på madrassen och kudden under testperioden. Antalet andningsuppehåll per timma sömn minskade i genomsnitt från 26 till 8. 14 av 15 patienter valde att fortsätta sova på madrassen och kudden som behandling för sin sjukdom.

Resultaten från studierna vid Sahlgrenska Universitetssjukhuset är lovande men fler studier är nödvändiga för att bekräfta effekten av dessa nya icke-kirurgiska metoder. Den nya metoden för tryckutjämning kan i framtiden utgöra ett möjligt behandlingsalternativ för barn med öronkatarr för att eventuellt undvika operation med plaströr. Madrassen och kudden för magläge kan hos patienter med snarkning och sömnapné vara ett alternativ till andra befintliga behandlingsmetoder.

## BIBLIOGRAPHY

1. Franklin KA, Rehnqvist N, Axelsson S. [Obstructive sleep apnea syndrome-diagnosis and treatment. A systematic literature review from SBU]. *Lakartidningen*. Oct 3-9 2007;104(40):2878-2881.
2. Qaseem A, Holty JE, Owens DK, Dallas P, Starkey M, Shekelle P. Management of Obstructive Sleep Apnea in Adults: A Clinical Practice Guideline From the American College of Physicians. *Annals of internal medicine*. Sep 24 2013.
3. Browning GG, Rovers MM, Williamson I, Lous J, Burton MJ. Grommets (ventilation tubes) for hearing loss associated with otitis media with effusion in children. *Cochrane Database Syst Rev*. 2010(10):CD001801.
4. Grote L, Hedner J, Grunstein R, Kraiczi H. Therapy with nCPAP: incomplete elimination of Sleep Related Breathing Disorder. *The European respiratory journal*. Nov 2000;16(5):921-927.
5. Marklund M. Predictors of long-term orthodontic side effects from mandibular advancement devices in patients with snoring and obstructive sleep apnea. *American journal of orthodontics and dentofacial orthopedics : official publication of the American Association of Orthodontists, its constituent societies, and the American Board of Orthodontics*. Feb 2006;129(2):214-221.
6. McArdle N, Devereux G, Heidarnejad H, Engleman HM, Mackay TW, Douglas NJ. Long-term use of CPAP therapy for sleep apnea/hypopnea syndrome. *American journal of respiratory and critical care medicine*. Apr 1999;159(4 Pt 1):1108-1114.
7. Weaver TE, Grunstein RR. Adherence to continuous positive airway pressure therapy: the challenge to effective treatment. *Proceedings of the American Thoracic Society*. Feb 15 2008;5(2):173-178.
8. Rovers MM, Straatman H, Ingels K, van der Wilt GJ, van den Broek P, Zielhuis GA. The effect of short-term ventilation tubes versus watchful waiting on hearing in young children with persistent otitis media with effusion: a randomized trial. *Ear and hearing*. Jun 2001;22(3):191-199.
9. Perera R, Glasziou PP, Heneghan CJ, McLellan J, Williamson I. Autoinflation for hearing loss associated with otitis media with effusion. *Cochrane Database Syst Rev*. 2013;5:CD006285.
10. Rovers MM, Zielhuis GA, Ingels K, van der Wilt GJ. Day-care and otitis media in young children: a critical overview. *European journal of pediatrics*. Jan 1999;158(1):1-6.
11. Stool SE, Berg AO. *Otitis Media with Effusion in Young Children: Clinical Practice Guideline*: Rockville, MD: Agency for Health Care Policy and Research; AHCPR Publication No. 94-0622; 1994.
12. Bluestone CD. *Otitis Media in Infants and Children*. Philadelphia: WB Saunders Company; 1988.
13. Lous J, Burton MJ, Felding JU, Ovesen T, Rovers MM, Williamson I. Grommets (ventilation tubes) for hearing loss associated with otitis media with effusion in children. *Cochrane Database Syst Rev*. 2005(1):CD001801.



14. Fria TJ, Cantekin EI, Eichler JA. Hearing acuity of children with otitis media with effusion. *Arch Otolaryngol.* Jan 1985;111(1):10-16.
15. Gravel JS, Wallace IF. Effects of otitis media with effusion on hearing in the first 3 years of life. *Journal of speech, language, and hearing research : JSLHR.* Jun 2000;43(3):631-644.
16. Mudry A. Never trust secondary references: examples from the early history of myringotomy and grommets. *International journal of pediatric otorhinolaryngology.* Nov 2008;72(11):1651-1656.
17. Valsalva AM, Morgagni G. *Antonii Mariae Valsalvae Opera. Hoc est Tractatus de aure humana editione hac quarta accuratissime descriptus, tabulisque archetypis exornatus, et Dissertationes anatomicae, quae nunc primum prodeunt, ad colon intestinum, ad arteriam magnam, ad accessorios nervos, ad oculos, ad suffusiones, & ad renum succenturiatorum excretorios ductus attinentes, tabulis itidem illustratae. Omnia recensuit, & auctoris vitam, suasque ad Tractatum, & Dissertationes Epistolas addidit duodeviginti Joannes Baptista Morgagnus. Tomi duo. Venetiis: Apud Franciscum Pitteri; 1741.*
18. Politzer A, Dodd O, Dalby WB. *A text-book of the diseases of the ear and adjacent organs.* Philadelphia: Lea Brothers & Co.; 1894.
19. Blanshard JD, Maw AR, Bawden R. Conservative treatment of otitis media with effusion by autoinflation of the middle ear. *Clinical otolaryngology and allied sciences.* Jun 1993;18(3):188-192.
20. Perera R, Haynes J, Glasziou P, Heneghan CJ. Autoinflation for hearing loss associated with otitis media with effusion. *Cochrane Database Syst Rev.* 2006(4):CD006285.
21. Hellstrom S, Pettersson A. [Tympanostomy tube treatment in otitis media. A systematic literature review. SBU summary and conclusions]. *Lakartidningen.* Jul 23-Aug 5 2008;105(30-31):2104-2106.
22. Guilleminault C, Dement WC. *Sleep Apnea Syndromes.* Canada: John Wiley & Sons Canada; 1988.
23. Young T, Palta M, Dempsey J, Skatrud J, Weber S, Badr S. The occurrence of sleep-disordered breathing among middle-aged adults. *The New England journal of medicine.* Apr 29 1993;328(17):1230-1235.
24. Iber C A-IS, Chesson A, Quan SF, ed *The AASM manual for the scoring of sleep and associated events: rules, terminology, and technical specification:* American Academy of Sleep Medicine, Westchester, IL; 2007.
25. Marshall NS, Wong KK, Liu PY, Cullen SR, Knuiam MW, Grunstein RR. Sleep apnea as an independent risk factor for all-cause mortality: the Busselton Health Study. *Sleep.* Aug 2008;31(8):1079-1085.
26. Young T, Finn L, Peppard PE, et al. Sleep disordered breathing and mortality: eighteen-year follow-up of the Wisconsin sleep cohort. *Sleep.* Aug 2008;31(8):1071-1078.
27. Karimi M, Eder DN, Eskandari D, Zou D, Hedner JA, Grote L. Impaired vigilance and increased accident rate in public transport operators is associated with sleep disorders. *Accident; analysis and prevention.* Mar 2013;51:208-214.
28. Sundaram S, Bridgman SA, Lim J, Lasserson TJ. Surgery for obstructive sleep apnoea. *Cochrane Database Syst Rev.* 2005(4):CD001004.

29. Fiellau-Nikolajsen M, Lous J. Prospective tympanometry in 3-year-old children. A study of the spontaneous course of tympanometry types in a nonselected population. *Arch Otolaryngol*. Aug 1979;105(8):461-466.
30. Rosenfeld RM, Kay D. Natural history of untreated otitis media. *The Laryngoscope*. Oct 2003;113(10):1645-1657.
31. Shekelle P, Takata G, Chan LS, et al. Diagnosis, natural history, and late effects of otitis media with effusion. *Evid Rep Technol Assess (Summ)*. Jun 2002(55):1-5.
32. Hellstrom S, Groth A, Jorgensen F, et al. Ventilation tube treatment: a systematic review of the literature. *Otolaryngology--head and neck surgery : official journal of American Academy of Otolaryngology-Head and Neck Surgery*. Sep 2011;145(3):383-395.
33. Schwartz DM, Schwartz RH, Redfield NP. Treatment of negative middle ear pressure and serous otitis media with Politzer's technique. An old procedure revisited. *Arch Otolaryngol*. Sep 1978;104(9):487-490.
34. Hunt-Williams R. A method for maintaining middle-ear ventilation in children. *The Journal of laryngology and otology*. Oct 1968;82(10):921-926.
35. Stangerup SE, Sederberg-Olsen J, Balle V. Autoinflation as a treatment of secretory otitis media. A randomized controlled study. *Archives of otolaryngology--head & neck surgery*. Feb 1992;118(2):149-152.
36. Fiellau-Nikolajsen M. Tympanometry and secretory otitis media. Observations on diagnosis, epidemiology, treatment, and prevention in prospective cohort studies of three-year-old children. *Acta otolaryngologica. Supplementum*. 1983;394:1-73.
37. Gravel JS, Fausel N, Liskow C, Chobot J. Children's speech recognition in noise using omni-directional and dual-microphone hearing aid technology. *Ear and hearing*. Feb 1999;20(1):1-11.
38. Zielhuis GA, Rach GH, van den Bosch A, van den Broek P. The prevalence of otitis media with effusion: a critical review of the literature. *Clinical otolaryngology and allied sciences*. Jun 1990;15(3):283-288.
39. Teele DW, Klein JO, Rosner B. Epidemiology of otitis media during the first seven years of life in children in greater Boston: a prospective, cohort study. *The Journal of infectious diseases*. Jul 1989;160(1):83-94.
40. Rovers MM, Schilder AG, Zielhuis GA, Rosenfeld RM. Otitis media. *Lancet*. Feb 7 2004;363(9407):465-473.
41. Bluestone CD. Pathogenesis of otitis media: role of eustachian tube. *The Pediatric infectious disease journal*. Apr 1996;15(4):281-291.
42. Bluestone CD. Eustachian tube function and dysfunction. In: Rosenfeld RM, Bluestone CD, eds. *Evidence-based otitis media*. Hamilton, Ont. ; London: B C Decker; 1999:137-156.
43. Chonmaitree T. Viral and bacterial interaction in acute otitis media. *The Pediatric infectious disease journal*. May 2000;19(5 Suppl):S24-30.
44. Winther B, Hayden FG, Arruda E, Dutkowski R, Ward P, Hendley JO. Viral respiratory infection in schoolchildren: effects on middle ear pressure. *Pediatrics*. May 2002;109(5):826-832.
45. Lim DJ, Chun YM, Lee HY, et al. Cell biology of tubotympanum in relation to pathogenesis of otitis media - a review. *Vaccine*. Dec 8 2000;19 Suppl 1:S17-25.

46. Bluestone CD. *Evidence-based otitis media*. Hamilton, ON: BC Decker; 1999.
47. Honjo I, Okazaki N, Kumazawa T. Experimental study of the Eustachian tube function with regard to its related muscles. *Acta oto-laryngologica*. Jan-Feb 1979;87(1-2):84-89.
48. Rich AR. A physiological study of the eustachian tube and its related muscles. *Otolaryngologic clinics of North America*. Feb 1970;3(1):147-162.
49. Honjo I, Hayashi M, Ito S, Takahashi H. Pumping and clearance function of the eustachian tube. *American journal of otolaryngology*. May-Jun 1985;6(3):241-244.
50. Bluestone CD, Paradise JL, Beery QC. Physiology of the eustachian tube in the pathogenesis and management of middle ear effusions. *The Laryngoscope*. Sep 1972;82(9):1654-1670.
51. Bluestone CD, Cantekin EI, Beery QC. Effect of inflammation of the ventilatory function of the eustachian tube. *The Laryngoscope*. Apr 1977;87(4 Pt 1):493-507.
52. Buchman CA, Doyle WJ, Skoner D, Fireman P, Gwaltney JM. Otolgic manifestations of experimental rhinovirus infection. *The Laryngoscope*. Oct 1994;104(10):1295-1299.
53. McBride TP, Doyle WJ, Hayden FG, Gwaltney JM, Jr. Alterations of the eustachian tube, middle ear, and nose in rhinovirus infection. *Archives of otolaryngology--head & neck surgery*. Sep 1989;115(9):1054-1059.
54. Friedman RA, Doyle WJ, Casselbrant ML, Bluestone C, Fireman P. Immunologic-mediated eustachian tube obstruction: a double-blind crossover study. *The Journal of allergy and clinical immunology*. May 1983;71(5):442-447.
55. Bluestone CD, Cantekin EI, Beery QC. Certain effects of adenoidectomy of Eustachian tube ventilatory function. *The Laryngoscope*. Jan 1975;85(1):113-127.
56. Buchman CA, Stool SE. Functional-anatomic correlation of eustachian tube obstruction related to the adenoid in a patient with otitis media with effusion: a case report. *Ear, nose, & throat journal*. Nov 1994;73(11):835-838.
57. Miura MS, Mascaro M, Rosenfeld RM. Association between otitis media and gastroesophageal reflux: a systematic review. *Otolaryngology--head and neck surgery : official journal of American Academy of Otolaryngology-Head and Neck Surgery*. Mar 2012;146(3):345-352.
58. Bylander A, Ivarsson A, Tjernstrom O. Eustachian tube function in normal children and adults. *Acta oto-laryngologica*. Nov-Dec 1981;92(5-6):481-491.
59. Alper CM, Tabari R, Seroky JT, Doyle WJ. Magnetic resonance imaging of the development of otitis media with effusion caused by functional obstruction of the eustachian tube. *The Annals of otology, rhinology, and laryngology*. May 1997;106(5):422-431.
60. Cantekin EI, Bluestone CD, Saez CA, Doyle WJ, Phillips DC. Normal and abnormal middle ear ventilation. *The Annals of otology, rhinology & laryngology. Supplement*. Jul-Aug 1977;86(4 Pt 3 Suppl 41):1-15.

61. Himi T, Suzuki T, Kodama H, Takezawa H, Kataura A. Immunologic characteristics of cytokines in otitis media with effusion. *The Annals of otology, rhinology & laryngology. Supplement.* Oct 1992;157:21-25.
62. Yellon RF, Leonard G, Marucha P, et al. Demonstration of interleukin 6 in middle ear effusions. *Archives of otolaryngology--head & neck surgery.* Jul 1992;118(7):745-748.
63. Jung TT, Park YM, Schlund D, et al. Effect of prostaglandin, leukotriene, and arachidonic acid on experimental otitis media with effusion in chinchillas. *The Annals of otology, rhinology & laryngology. Supplement.* Jun 1990;148:28-32.
64. Doyle WJ, Seroky JT. Middle ear gas exchange in rhesus monkeys. *The Annals of otology, rhinology, and laryngology.* Aug 1994;103(8 Pt 1):636-645.
65. Rogers DJ, Boseley ME, Adams MT, Makowski RL, Hohman MH. Prospective comparison of handheld pneumatic otoscopy, binocular microscopy, and tympanometry in identifying middle ear effusions in children. *International journal of pediatric otorhinolaryngology.* Oct 2010;74(10):1140-1143.
66. Young DE, Ten Cate WJ, Ahmad Z, Morton RP. The accuracy of otomicroscopy for the diagnosis of paediatric middle ear effusions. *International journal of pediatric otorhinolaryngology.* Jun 2009;73(6):825-828.
67. Takata GS, Chan LS, Morphew T, Mangione-Smith R, Morton SC, Shekelle P. Evidence assessment of the accuracy of methods of diagnosing middle ear effusion in children with otitis media with effusion. *Pediatrics.* Dec 2003;112(6 Pt 1):1379-1387.
68. Tympanometry. ASHA Working Group on Aural Acoustic-Immittance Measurements Committee on Audiologic Evaluation. *The Journal of speech and hearing disorders.* Nov 1988;53(4):354-377.
69. Holmberg K, Axelsson A, Hansson P, Renvall U. Comparison of tympanometry and otomicroscopy during healing of otitis media. *Scandinavian audiology.* 1986;15(1):3-8.
70. Zielhuis GA, Rach GH, van den Broek P. Screening for otitis media with effusion in preschool children. *Lancet.* Feb 11 1989;1(8633):311-314.
71. Jerger J. Clinical experience with impedance audiometry. *Arch Otolaryngol.* Oct 1970;92(4):311-324.
72. Robert A, Van Hernel S, VA Hernel D. *Hearing Loss: Determining Eligibility for Social Security Benefits* 2004.
73. American Speech-Language-Hearing Association. *Guidelines for manual pure-tone threshold audiometry.* 20 ed 1978.
74. American National Standards Institute. *Maximum Permissible Ambient Noise Levels for Audiometric Test Rooms.* New York: Acoustical Society of America; 1991.
75. American National Standards Institute. *Methods for manual pure-tone threshold audiometry.* New York: Acoustical Society of America; 2004.
76. American Speech-Language-Hearing Association. Sound field measurement tutorial. Working Group on Sound Field Calibration of the Committee on Audiologic Evaluation American Speech-Language-Hearing Association. *ASHA Suppl.* 1991;Jan(3):25-38.

77. Atkinson M. Surgical management of otitis media with effusion in children--NICE guideline: what paediatricians need to know. *Archives of disease in childhood. Education and practice edition*. Aug 2009;94(4):115-117.
78. Otitis media with effusion. *Pediatrics*. May 2004;113(5):1412-1429.
79. Armstrong BW. A new treatment for chronic secretory otitis media. *A.M.A. archives of otolaryngology*. Jun 1954;59(6):653-654.
80. Schilder AG, Lok W, Rovers MM. International perspectives on management of acute otitis media: a qualitative review. *International journal of pediatric otorhinolaryngology*. Jan 2004;68(1):29-36.
81. Black N. Geographical variations in use of surgery for glue ear. *Journal of the Royal Society of Medicine*. Aug 1985;78(8):641-648.
82. Wallace IF, Berkman ND, Lohr KN, Harrison MF, Kimple AJ, Steiner MJ. Surgical treatments for otitis media with effusion: a systematic review. *Pediatrics*. Feb 2014;133(2):296-311.
83. Griffin G, Flynn CA. Antihistamines and/or decongestants for otitis media with effusion (OME) in children. *Cochrane Database Syst Rev*. 2011(9):CD003423.
84. Williamson I, Benghe S, Barton S, et al. Topical intranasal corticosteroids in 4-11 year old children with persistent bilateral otitis media with effusion in primary care: double blind randomised placebo controlled trial. *BMJ*. 2009;339:b4984.
85. Shea JJ. Autoinflation treatment of serous otitis media in children. *The Journal of laryngology and otology*. Dec 1971;85(12):1254-1258.
86. Cantekin EI, Bluestone CD, Parkin LP. Eustachian tube ventilatory function in children. *The Annals of otology, rhinology, and laryngology*. Mar-Apr 1976;85(2 Suppl 25 Pt 2):171-177.
87. Arick DS, Silman S. Nonsurgical home treatment of middle ear effusion and associated hearing loss in children. Part I: clinical trial. *Ear, nose, & throat journal*. Sep 2005;84(9):567-568, 570-564, 576 passim.
88. Silman S, Arick DS, Emmer MB. Nonsurgical home treatment of middle ear effusion and associated hearing loss in children. Part II: Validation study. *Ear, nose, & throat journal*. Oct 2005;84(10):646, 648, 650 passim.
89. Avicenna. *The canon of medicine*. Vol 2, 3. Second ed. Tehran, Iran: Sorouspress; 1119.
90. Ormerod W. Richard Caton (1842-1926): pioneer electrophysiologist and cardiologist. *Journal of medical biography*. Feb 2006;14(1):30-35.
91. Berger J. Uber das Elektrenkephalogramm des Menchen. *Arch Psychiatr Nervenkr*. 1929;87:527-570.
92. Rechtschaffen A, Kales A. *A manual of standardized terminology, techniques, and scoring system for sleep stages of human subjects*. Washington, DC: Public Health Service, U.S. Government Printing Service; 1968.
93. Dickens C. *Posthumous Papers of Pickwick*.
94. Lavie P. Nothing new under the moon. Historical accounts of sleep apnea syndrome. *Archives of internal medicine*. Oct 1984;144(10):2025-2028.
95. Mathis J. [The history of sleep research in the 20th century]. *Praxis*. Dec 12 1995;84(50):1479-1485.



96. Robin P. Glossoptosis due to atresia and hypertrophy of the mandible. *Am J Dis Child.* 1934;48:541-547.
97. Cartwright RD, Samelson CF. The effects of a nonsurgical treatment for obstructive sleep apnea. The tongue-retaining device. *JAMA : the journal of the American Medical Association.* Aug 13 1982;248(6):705-709.
98. Soll BA, George PT. Treatment of obstructive sleep apnea with a nocturnal airway-patency appliance. *The New England journal of medicine.* Aug 8 1985;313(6):386-387.
99. Sullivan CE, Issa FG, Berthon-Jones M, Eves L. Reversal of obstructive sleep apnoea by continuous positive airway pressure applied through the nares. *Lancet.* Apr 18 1981;1(8225):862-865.
100. Fujita S, Conway W, Zorick F, Roth T. Surgical correction of anatomic abnormalities in obstructive sleep apnea syndrome: uvulopalatopharyngoplasty. *Otolaryngology--head and neck surgery : official journal of American Academy of Otolaryngology-Head and Neck Surgery.* Nov-Dec 1981;89(6):923-934.
101. Ravesloot MJ, van Maanen JP, Dun L, de Vries N. The undervalued potential of positional therapy in position-dependent snoring and obstructive sleep apnea-a review of the literature. *Sleep & breathing = Schlaf & Atmung.* Mar 2013;17(1):39-49.
102. Woodson BT, Franco R. Physiology of sleep disordered breathing. *Otolaryngologic clinics of North America.* Aug 2007;40(4):691-711.
103. Quinn SJ, Daly N, Ellis PD. Observation of the mechanism of snoring using sleep nasendoscopy. *Clinical otolaryngology and allied sciences.* Aug 1995;20(4):360-364.
104. Pepin JL, Guillot M, Tamisier R, Levy P. The upper airway resistance syndrome. *Respiration; international review of thoracic diseases.* 2012;83(6):559-566.
105. Sleep-related breathing disorders in adults: recommendations for syndrome definition and measurement techniques in clinical research. The Report of an American Academy of Sleep Medicine Task Force. *Sleep.* Aug 1 1999;22(5):667-689.
106. American Association of Sleep Medicine. *Diagnostic and coding manual.* 2nd ed. Westchester, IL: International classification of sleep disorders; 2005.
107. Duran J, Esnaola S, Rubio R, Iztueta A. Obstructive sleep apnea-hypopnea and related clinical features in a population-based sample of subjects aged 30 to 70 yr. *American journal of respiratory and critical care medicine.* Mar 2001;163(3 Pt 1):685-689.
108. Young T, Shahar E, Nieto FJ, et al. Predictors of sleep-disordered breathing in community-dwelling adults: the Sleep Heart Health Study. *Archives of internal medicine.* Apr 22 2002;162(8):893-900.
109. Ferini-Strambi L, Zucconi M, Castronovo V, Garancini P, Oldani A, Smirne S. Snoring & sleep apnea: a population study in Italian women. *Sleep.* Nov 1 1999;22(7):859-864.
110. Ferini-Strambi L, Zucconi M, Palazzi S, et al. Snoring and nocturnal oxygen desaturations in an Italian middle-aged male population. Epidemiologic study with an ambulatory device. *Chest.* Jun 1994;105(6):1759-1764.

111. O'Connor C, Thornley KS, Hanly PJ. Gender differences in the polysomnographic features of obstructive sleep apnea. *American journal of respiratory and critical care medicine*. May 2000;161(5):1465-1472.
112. Young T, Skatrud J, Peppard PE. Risk factors for obstructive sleep apnea in adults. *JAMA : the journal of the American Medical Association*. Apr 28 2004;291(16):2013-2016.
113. Peppard PE, Young T, Palta M, Dempsey J, Skatrud J. Longitudinal study of moderate weight change and sleep-disordered breathing. *JAMA : the journal of the American Medical Association*. Dec 20 2000;284(23):3015-3021.
114. Schwartz AR, Patil SP, Laffan AM, Polotsky V, Schneider H, Smith PL. Obesity and obstructive sleep apnea: pathogenic mechanisms and therapeutic approaches. *Proceedings of the American Thoracic Society*. Feb 15 2008;5(2):185-192.
115. Hoffstein V, Mateika S. Cardiac arrhythmias, snoring, and sleep apnea. *Chest*. Aug 1994;106(2):466-471.
116. Hedner J, Grote L, Bonsignore M, et al. The European Sleep Apnoea Database (ESADA): report from 22 European sleep laboratories. *The European respiratory journal*. Sep 2011;38(3):635-642.
117. Butt M, Dwivedi G, Khair O, Lip GY. Obstructive sleep apnea and cardiovascular disease. *International journal of cardiology*. Feb 18 2010;139(1):7-16.
118. Carlson JT, Hedner J, Elam M, Ejnell H, Sellgren J, Wallin BG. Augmented resting sympathetic activity in awake patients with obstructive sleep apnea. *Chest*. Jun 1993;103(6):1763-1768.
119. Marrone O, Riccobono L, Salvaggio A, Mirabella A, Bonanno A, Bonsignore MR. Catecholamines and blood pressure in obstructive sleep apnea syndrome. *Chest*. Mar 1993;103(3):722-727.
120. Krieger J, McNicholas WT, Levy P, et al. Public health and medicolegal implications of sleep apnoea. *The European respiratory journal*. Dec 2002;20(6):1594-1609.
121. Spiegel K, Leproult R, Van Cauter E. Impact of sleep debt on metabolic and endocrine function. *Lancet*. Oct 23 1999;354(9188):1435-1439.
122. Punjabi NM, Sorkin JD, Katzel LI, Goldberg AP, Schwartz AR, Smith PL. Sleep-disordered breathing and insulin resistance in middle-aged and overweight men. *American journal of respiratory and critical care medicine*. Mar 1 2002;165(5):677-682.
123. Peppard PE, Young T, Palta M, Skatrud J. Prospective study of the association between sleep-disordered breathing and hypertension. *The New England journal of medicine*. May 11 2000;342(19):1378-1384.
124. Logan AG, Perlikowski SM, Mente A, et al. High prevalence of unrecognized sleep apnoea in drug-resistant hypertension. *Journal of hypertension*. Dec 2001;19(12):2271-2277.
125. Chobanian AV, Bakris GL, Black HR, et al. The Seventh Report of the Joint National Committee on Prevention, Detection, Evaluation, and Treatment of High Blood Pressure: the JNC 7 report. *JAMA : the journal of the American Medical Association*. May 21 2003;289(19):2560-2572.

126. Parati G, Lombardi C, Hedner J, et al. Recommendations for the management of patients with obstructive sleep apnoea and hypertension. *The European respiratory journal*. Mar 2013;41(3):523-538.
127. Iranzo A, Santamaria J, Berenguer J, Sanchez M, Chamorro A. Prevalence and clinical importance of sleep apnea in the first night after cerebral infarction. *Neurology*. Mar 26 2002;58(6):911-916.
128. Kaneko Y, Hajek VE, Zivanovic V, Raboud J, Bradley TD. Relationship of sleep apnea to functional capacity and length of hospitalization following stroke. *Sleep*. May 1 2003;26(3):293-297.
129. Marin JM, Carrizo SJ, Vicente E, Agusti AG. Long-term cardiovascular outcomes in men with obstructive sleep apnoea-hypopnoea with or without treatment with continuous positive airway pressure: an observational study. *Lancet*. Mar 19-25 2005;365(9464):1046-1053.
130. Findley LJ, Wilhoit SC, Suratt PM. Apnea duration and hypoxemia during REM sleep in patients with obstructive sleep apnea. *Chest*. Apr 1985;87(4):432-436.
131. Woodson BT. Expiratory pharyngeal airway obstruction during sleep: a multiple element model. *The Laryngoscope*. Sep 2003;113(9):1450-1459.
132. Leitzen KP, Brietzke SE, Lindsay RW. Correlation between Nasal Anatomy and Objective Obstructive Sleep Apnea Severity. *Otolaryngology--head and neck surgery : official journal of American Academy of Otolaryngology-Head and Neck Surgery*. Feb 2014;150(2):325-331.
133. Rappai M, Collop N, Kemp S, deShazo R. The nose and sleep-disordered breathing: what we know and what we do not know. *Chest*. Dec 2003;124(6):2309-2323.
134. Young T, Finn L, Kim H. Nasal obstruction as a risk factor for sleep-disordered breathing. The University of Wisconsin Sleep and Respiratory Research Group. *The Journal of allergy and clinical immunology*. Feb 1997;99(2):S757-762.
135. Rodenstein DO, Doooms G, Thomas Y, et al. Pharyngeal shape and dimensions in healthy subjects, snorers, and patients with obstructive sleep apnoea. *Thorax*. Oct 1990;45(10):722-727.
136. Dempsey JA, Skatrud JB, Jacques AJ, et al. Anatomic determinants of sleep-disordered breathing across the spectrum of clinical and nonclinical male subjects. *Chest*. Sep 2002;122(3):840-851.
137. Schwab RJ, Pasirstein M, Pierson R, et al. Identification of upper airway anatomic risk factors for obstructive sleep apnea with volumetric magnetic resonance imaging. *American journal of respiratory and critical care medicine*. Sep 1 2003;168(5):522-530.
138. Ganong WF. *Review of Medical Physiology*. Sixteenth edition ed. Connecticut, USA: Wiley; 1993.
139. Hsia JC, Camacho M, Capasso R. Snoring exclusively during nasal breathing: a newly described respiratory pattern during sleep. *Sleep & breathing = Schlaf & Atmung*. Mar 2014;18(1):159-164.
140. Beaumont M, Fodil R, Isabey D, et al. Gravity effects on upper airway area and lung volumes during parabolic flight. *J Appl Physiol (1985)*. May 1998;84(5):1639-1645.
141. Cartwright RD. Effect of sleep position on sleep apnea severity. *Sleep*. 1984;7(2):110-114.



142. Horner RL. Motor control of the pharyngeal musculature and implications for the pathogenesis of obstructive sleep apnea. *Sleep*. Dec 1996;19(10):827-853.
143. Lindman R, Stal PS. Abnormal palatopharyngeal muscle morphology in sleep-disordered breathing. *Journal of the neurological sciences*. Mar 15 2002;195(1):11-23.
144. Svanborg E. Impact of obstructive apnea syndrome on upper airway respiratory muscles. *Respiratory physiology & neurobiology*. Jul 28 2005;147(2-3):263-272.
145. Zanation AM, Senior BA. The relationship between extraesophageal reflux (EER) and obstructive sleep apnea (OSA). *Sleep medicine reviews*. Dec 2005;9(6):453-458.
146. Senior BA, Khan M, Schwimmer C, Rosenthal L, Benninger M. Gastroesophageal reflux and obstructive sleep apnea. *The Laryngoscope*. Dec 2001;111(12):2144-2146.
147. Arand D, Bonnet M, Hurwitz T, Mitler M, Rosa R, Sangal RB. The clinical use of the MSLT and MWT. *Sleep*. Jan 2005;28(1):123-144.
148. Kakkar RK, Hill GK. Interpretation of the adult polysomnogram. *Otolaryngologic clinics of North America*. Aug 2007;40(4):713-743.
149. Sackett DL, Haynes RB, Tugwel P. *Clinical epidemiology: a basic science for clinical medicine*. Boston: Lippincott Williams & Wilkins; 1991.
150. SBU. *Obstructive Sleep Apnoea Syndrome- Report of a joint Nordic project. A systemis litterature review*. . Norrköping, Sweden: Staten beredning för medicinsk utvärdering (SBU);2007.
151. Driver HS, Pereira EJ, Bjerring K, et al. Validation of the MediByte(R) type 3 portable monitor compared with polysomnography for screening of obstructive sleep apnea. *Canadian respiratory journal : journal of the Canadian Thoracic Society*. May-Jun 2011;18(3):137-143.
152. Ng SS, Chan TO, To KW, et al. Validation of Embletta portable diagnostic system for identifying patients with suspected obstructive sleep apnoea syndrome (OSAS). *Respirology*. Feb 2010;15(2):336-342.
153. Gastaut H, Tassinari CA, Duron B. Polygraphic study of the episodic diurnal and nocturnal (hypnic and respiratory) manifestations of the Pickwick syndrome. *Brain research*. Feb 1966;1(2):167-186.
154. Le Bon O, Hoffmann G, Tecco J, et al. Mild to moderate sleep respiratory events: one negative night may not be enough. *Chest*. Aug 2000;118(2):353-359.
155. Levendowski DJ, Zack N, Rao S, et al. Assessment of the test-retest reliability of laboratory polysomnography. *Sleep & breathing = Schlaf & Atmung*. May 2009;13(2):163-167.
156. Aarab G, Lobbezoo F, Hamburger HL, Naeije M. Variability in the apnea-hypopnea index and its consequences for diagnosis and therapy evaluation. *Respiration; international review of thoracic diseases*. 2009;77(1):32-37.
157. Gouveris H, Selivanova O, Bausmer U, Goepel B, Mann W. First-night-effect on polysomnographic respiratory sleep parameters in patients with sleep-disordered breathing and upper airway pathology. *Eur Arch Otorhinolaryngol*. Sep 2010;267(9):1449-1453.

158. Nguyen AT, Baltzan MA, Small D, Wolkove N, Guillon S, Palayew M. Clinical reproducibility of the Epworth Sleepiness Scale. *Journal of clinical sleep medicine : JCSM : official publication of the American Academy of Sleep Medicine*. Apr 15 2006;2(2):170-174.
159. Johns MW. A new method for measuring daytime sleepiness: the Epworth sleepiness scale. *Sleep*. Dec 1991;14(6):540-545.
160. Sullivan SS, Kushida CA. Multiple sleep latency test and maintenance of wakefulness test. *Chest*. Oct 2008;134(4):854-861.
161. Friedman M. Sleep endoscopy versus modified Mallampati score for OSA and snoring. *The Laryngoscope*. Nov 2005;115(11):2072-2073; author reply 2073-2074.
162. Thakkar K, Yao M. Diagnostic studies in obstructive sleep apnea. *Otolaryngologic clinics of North America*. Aug 2007;40(4):785-805.
163. Engleman HM, McDonald JP, Graham D, et al. Randomized crossover trial of two treatments for sleep apnea/hypopnea syndrome: continuous positive airway pressure and mandibular repositioning splint. *American journal of respiratory and critical care medicine*. Sep 15 2002;166(6):855-859.
164. Tan YK, L'Estrange PR, Luo YM, et al. Mandibular advancement splints and continuous positive airway pressure in patients with obstructive sleep apnoea: a randomized cross-over trial. *European journal of orthodontics*. Jun 2002;24(3):239-249.
165. Chowdhuri S. Continuous positive airway pressure for the treatment of sleep apnea. *Otolaryngologic clinics of North America*. Aug 2007;40(4):807-827.
166. Moura SM, Bittencourt LR, Bagnato MC, Lucas SR, Tufik S, Nery LE. Acute effect of nasal continuous positive air pressure on the ventilatory control of patients with obstructive sleep apnea. *Respiration; international review of thoracic diseases*. 2001;68(3):243-249.
167. Kribbs NB, Pack AI, Kline LR, et al. Objective measurement of patterns of nasal CPAP use by patients with obstructive sleep apnea. *The American review of respiratory disease*. Apr 1993;147(4):887-895.
168. Pepin JL, Leger P, Veale D, Langevin B, Robert D, Levy P. Side effects of nasal continuous positive airway pressure in sleep apnea syndrome. Study of 193 patients in two French sleep centers. *Chest*. Feb 1995;107(2):375-381.
169. Chan AS, Lee RW, Srinivasan VK, Darendeliler MA, Grunstein RR, Cistulli PA. Nasopharyngoscopic evaluation of oral appliance therapy for obstructive sleep apnoea. *The European respiratory journal*. Apr 2010;35(4):836-842.
170. Chan AS, Sutherland K, Schwab RJ, et al. The effect of mandibular advancement on upper airway structure in obstructive sleep apnoea. *Thorax*. Aug 2010;65(8):726-732.
171. Tsuiki S, Ono T, Kuroda T. Mandibular Advancement Modulates Respiratory-Related Genioglossus Electromyographic Activity. *Sleep & breathing = Schlaf & Atmung*. 2000;4(2):53-58.
172. Marklund M, Franklin KA. Long-term effects of mandibular repositioning appliances on symptoms of sleep apnoea. *Journal of sleep research*. Dec 2007;16(4):414-420.

173. Chung JW, Enciso R, Levendowski DJ, Morgan TD, Westbrook PR, Clark GT. Treatment outcomes of mandibular advancement devices in positional and nonpositional OSA patients. *Oral surgery, oral medicine, oral pathology, oral radiology, and endodontics*. May 2010;109(5):724-731.
174. Marklund M, Persson M, Franklin KA. Treatment success with a mandibular advancement device is related to supine-dependent sleep apnea. *Chest*. Dec 1998;114(6):1630-1635.
175. Sher AE, Schechtman KB, Piccirillo JF. The efficacy of surgical modifications of the upper airway in adults with obstructive sleep apnea syndrome. *Sleep*. Feb 1996;19(2):156-177.
176. Senior BA, Rosenthal L, Lumley A, Gerhardstein R, Day R. Efficacy of uvulopalatopharyngoplasty in unselected patients with mild obstructive sleep apnea. *Otolaryngology--head and neck surgery : official journal of American Academy of Otolaryngology-Head and Neck Surgery*. Sep 2000;123(3):179-182.
177. Friedman M, Schalch P. Surgery of the palate and oropharynx. *Otolaryngologic clinics of North America*. Aug 2007;40(4):829-843.
178. Browaldh N, Nerfeldt P, Lysdahl M, Bring J, Friberg D. SKUP3 randomised controlled trial: polysomnographic results after uvulopalatopharyngoplasty in selected patients with obstructive sleep apnoea. *Thorax*. Sep 2013;68(9):846-853.
179. Conradt R, Hochban W, Brandenburg U, Heitmann J, Peter JH. Long-term follow-up after surgical treatment of obstructive sleep apnoea by maxillomandibular advancement. *The European respiratory journal*. Jan 1997;10(1):123-128.
180. Li KK, Powell NB, Riley RW, Troell RJ, Guilleminault C. Long-Term Results of Maxillomandibular Advancement Surgery. *Sleep & breathing = Schlaf & Atmung*. 2000;4(3):137-140.
181. Oksenberg A. Positional and non-positional obstructive sleep apnea patients. *Sleep medicine*. Jul 2005;6(4):377-378.
182. Oksenberg A, Silverberg DS. The effect of body posture on sleep-related breathing disorders: facts and therapeutic implications. *Sleep medicine reviews*. Aug 1998;2(3):139-162.
183. Oksenberg A, Silverberg DS, Arons E, Radwan H. Positional vs nonpositional obstructive sleep apnea patients: anthropomorphic, nocturnal polysomnographic, and multiple sleep latency test data. *Chest*. Sep 1997;112(3):629-639.
184. Richard W, Kox D, den Herder C, Laman M, van Tinteren H, de Vries N. The role of sleep position in obstructive sleep apnea syndrome. *Eur Arch Otorhinolaryngol*. Oct 2006;263(10):946-950.
185. Sunnergren O, Brostrom A, Svanborg E. Positional sensitivity as a confounder in diagnosis of severity of obstructive sleep apnea. *Sleep & breathing = Schlaf & Atmung*. Mar 2013;17(1):173-179.
186. Skinner MA, Kingshott RN, Filsell S, Taylor DR. Efficacy of the 'tennis ball technique' versus nCPAP in the management of position-dependent obstructive sleep apnoea syndrome. *Respirology*. Sep 2008;13(5):708-715.
187. Permut I, Diaz-Abad M, Chatila W, et al. Comparison of positional therapy to CPAP in patients with positional obstructive sleep apnea. *Journal of*

- clinical sleep medicine : JCSM : official publication of the American Academy of Sleep Medicine.* Jun 15 2010;6(3):238-243.
188. Heinzer RC, Pellaton C, Rey V, et al. Positional therapy for obstructive sleep apnea: an objective measurement of patients' usage and efficacy at home. *Sleep medicine.* Apr 2012;13(4):425-428.
  189. van Maanen JP, Meester KA, Dun LN, et al. The sleep position trainer: a new treatment for positional obstructive sleep apnoea. *Sleep & breathing = Schlaf & Atmung.* May 2013;17(2):771-779.
  190. Kavey NB, Blitzer A, Gidro-Frank S, Korstanje K. Sleeping position and sleep apnea syndrome. *American journal of otolaryngology.* Sep-Oct 1985;6(5):373-377.
  191. Matsuzawa Y, Hayashi S, Yamaguchi S, et al. Effect of prone position on apnea severity in obstructive sleep apnea. *Intern Med.* Dec 1995;34(12):1190-1193.
  192. Menon A, Kumar M. Influence of Body Position on Severity of Obstructive Sleep Apnea: A Systematic Review. *ISRN otolaryngology.* 2013;2013:670381.





