

NR 2000:4

Proceedings of the Third International Meeting on
Thermal Manikin Testing
3IMM

at the National Institute for Working Life
October 12–13, 1999

Håkan O Nilsson and Ingvar Holmér (eds)

ARBETE OCH HÄLSA | VETENSKAPLIG SKRIFTSERIE

ISBN 91-7045-554-6 ISSN 0346-7821 <http://www.niwl.se/ah/>



The National Institute for Working Life is a national centre of knowledge for issues concerning working life. The Institute carries out research and development covering the whole field of working life, on commission from The Ministry of Industry, Employment and Communications.

The goals of the National Institute for Working Life are to contribute to:

- Renewal and development of working life
- Long-term accumulation of knowledge and competence
- Reduced risk of ill-health and accidents

Research and development are concentrated into three main areas: the labour market, the organisation of work and the work environment. Research is multidisciplinary and arises from problems and trends in working life. Operations are carried out in around 20 programmes. Communication and the spreading of information are important aspects of our work.

It is in the meeting between theory and practice, between researcher and worker, that new ideas are created that lead to development. It is an important task for the National Institute for Working Life to create the conditions needed for these meetings. The Institute collaborates with the social partners, the business world, universities and university colleges, with international partners and with others active in the field of working life.

Different regions in Sweden have unique conditions for the development of working life. The National Institute for Working Life is found in Bergslagen, Göteborg, Malmö, Norrköping, Solna, Stockholm, Söderhamn, Umeå and Östersund.

For more information, or to come into contact with us, visit our website www.niwl.se

ARBETE OCH HÄLSA

Editor-in-chief: Staffan Marklund
Co-editors: Mikael Bergenheim, Anders Kjellberg,
Birgitta Meding, Gunnar Rosén och Ewa Wigaeus
Hjelm

© National Institut for Working Life & authors 2000

National Institute for Working Life
S-112 79 Stockholm
Sweden

ISBN 91-7045-554-6
ISSN 0346-7821
<http://www.niwl.se/ah/>
Printed at CM Gruppen

Foreword

The third international meeting for users of thermal manikins was organised by the National Institute for Working Life in Stockholm, Sweden on October 12-13, 1999. The first meeting was organised at the same place in February, 1997. Proceedings can be obtained from the organisers. The second meeting took place in Halifax, Canada in June, 1997.

Thermal manikins provide a useful and valuable complement to direct experiments with human subjects. In conditions where the heat exchange of is complex and transient measurements with a thermal manikin produce relevant, reliable and accurate values for whole body as well as local heat exchange. Such values are useful for

- detailed assessment of thermal stress in environments with human occupancy
- determination of heat transfer and thermal properties of clothing
- prediction of human responses to extreme or complex thermal conditions
- validation of results from human experiments regarding thermal stress
- simulation of responses in humans exposed to thermal environments

Thermal manikins are traditionally used by research institutes for climate research. In recent years manikins are increasingly used in many practical applications. Today are manikins frequently used for testing and product development by the building industry and by the automobile industry for evaluation of the performance of heating and ventilation systems. The clothing industry uses manikins for development of clothing systems with improved thermal properties. Test houses perform tests on protective clothing according to defined European or international standards. This kind of work results in continuous improvement of environments and products of importance for comfort, health and safety in working life.

The aim of this series of meetings is to bring together users and manufacturers of thermal manikins for discussion around subjects of mutual interest such as

- research results
- technical issues
- evaluation methods
- calibration procedures
- development of manikin standards
- new application fields
- manikin network

We appreciate and acknowledge the special support of the meeting from Taiga AB.

Information from the different fields of manikin testing will be available at http://www.niwl.se/tema/klimat/mer_manikin_en.htm

Håkan O. Nilsson

Ingvar Holmér

Contents

Thermal manikins in research and standards: <i>Ingvar Holmér</i>	1
Interlaboratory trial of thermal manikin based on thermal insulation of cold protective clothing in accordance with ENV 342: <i>Hannu Anttonen</i>	9
Standardisation of measuring clothing thermal resistance with thermal manikin: <i>Jiang Zhihua and Shen Yuhang</i>	13
Test research of a new generation thermal manikin: <i>Krzysztof Soltynski, Maria Konarska, Jerzy Pyryt, Andrzej Sobolewski</i>	19
Manikin needs in sport field: <i>Hayet Sari</i>	24
Comfort temperatures for sleeping bags: <i>Bård Holand</i>	26
Use of a thermal manikin for prediction of local effects of thermal asymmetry and consequent discomfort risks: <i>Victor Candas</i>	30
Assessment of the physiological wear comfort of garments via a thermal manikin: <i>V. T. Bartels and K.-H. Umbach</i>	35
Research of human non-evaporative heat diffusion pattern and mathematical model at low temperatures: <i>Yang Tingxing</i>	39
Factors affecting the equivalent temperature measured with thermal manikins: <i>Mats Bohm</i>	46
The use of thermal manikin in the field: <i>Håkan O. Nilsson</i>	59
Presentation of a Dummy REpresenting Suit for Simulation of huMAN heatloss (DRESSMAN): <i>Erhard Mayer</i>	67
Development of a breathing thermal manikin: <i>Thomas Lund Madsen</i>	74
Simulation of human respiration with breathing thermal manikin: <i>Erik Bjørn</i>	79
Measurement of indoor air quality by means of a breathing thermal manikin: <i>Henrik Brohus</i>	84
The Importance of a thermal manikin as source and obstacle in full-scale experiments: <i>Peter V. Nielsen</i>	89
Extraction of data from sweating manikin tests: <i>Harriet Meinander</i>	96
Use sweating articulated manikin SAM for thermophysiological assessment of complete garments: <i>Niklaus Mattle</i>	101
CYBOR sweating concept: <i>Wolfgang Uedelhoven and Bernhard Kurz</i>	103
One week sweating simulation test with a thermal foot model: <i>Kalev Kuklane, Ingvar Holmér, Gordon Giesbrecht</i>	107
Participant list 3IMM 1999	115

Thermal manikins in research and standards

Ingvar Holmér
Climate Research Group
National Institute for Working Life
Solna, Sweden

Introduction

The interest in using thermal manikins in research and measurement standards has grown in recent years. This is seen in the number of manikins being manufactured and used and the organisation of international meetings specifically devoted to the thermal manikin applications. The first meeting was organised in Stockholm in 1997 (Nilsson, Holmér, 1997) and was followed, independently by a second one in the same year in Halifax. This meeting is the third international meeting (3IMM) on thermal manikin testing. This paper presents an overview of thermal manikins in use. It is not complete but rather an illustration of the diverse constructions and their application fields. The papers presented at this meeting provide additional and more detailed information on this subject.

History of thermal manikins

Wyon published in 1989 (Wyon, 1989) a comprehensive review of the subject and a relatively complete list of the available manikins. It was complemented with new examples by Holmér in 1994 (Holmér, Nilsson, 1994). The number of manikins has considerably increased and may count more than 80 in use worldwide. Table 1 presents a list of milestones in the development of thermal manikins. Each new example represents a significant improvement in the technique. Country of development and the approximate year of construction are indicated. References below are not necessarily the first, but provide information about the different manikins.

It all started with the one-segment copper manikin made for the US Army in the early 40's (Belding, 1949). Several of this kind were manufactured and also used for indoor climate (HVAC) research. A few of them are still in use. The need for more detailed information brought forward the construction of manikins with several, independently controlled segments over the body surface (from 2, except 7). Almost all manikins today provide for more than 15 segments. To reduce costs cheaper materials have been used and many of the modern manikins are made of plastic material.

A significant step forward was taken with the introduction of digital regulation techniques. This allowed for more flexible protocols and accurate measurements. So far all manikins measured heat losses, but a French manikin was constructed with a cooling technique that allowed measurements of heat gain (Aubertin Cornu, 1977). It was used for the assessment of heat protective clothing. A similar application field was aimed for with the "Thermo-man" manikin. It is a passive

manikin equipped with sensors for detection of surface temperatures during exposure to intensive convective or radiative heat (Behnke et al., 1990).

It was early recognised that a static, standing thermal manikin provided test values with limited relevance to actual user conditions. Manikins were constructed with joints that allowed the manikin to be seated. With more robust constructions manikins could even be constantly moveable, i.e. perform “walking” or “cycling” movements (4 - 6, 11). Most of the manikins are used for clothing evaluation. Clothing for protection against cold water required a special type of thermal manikin to be developed (9).

Table 1. Milestones in the development of human shaped thermal manikins (modified from (Wyon, 1989) and (Holmér and Nilsson, 1994). Complete references to the examples in the list below can be found in these two papers

1	one-segment	copper	analogue		USA 1945
2	multi-segment	aluminium	analogue		UK 1964
3	radiation manikin	aluminium	analogue		France 1972
4	multi-segment	plastics	analogue	moveable	Denmark 1973
5	multi-segment	plastics	analogue	moveable	Germany 1978
6	multi-segment	plastics	digital	moveable	Sweden 1980
7	multi-segment	plastics	digital	moveable	Sweden 1984
8	fire manikin	aluminium	digital		USA
9	immersion manikin	aluminium	digital	moveable	Canada 1988
10	sweating manikin	aluminium plastic aluminium	digital digital digital	moveable moveable	Japan 1988 Finland 1988 USA 1996
11	female manikin	plastics single wire	digital, comfort regulation mode	moveable	Denmark 1989
12	breathing thermal manikin	plastics single wire	digital, comfort regulation mode	moveable, breathing simulation	Denmark 1996

A complete understanding of human heat exchange requires not only convective, conductive and radiative heat losses to be measured. In the heat the main mechanism for heat loss is sweat evaporation. A few manikins in operation can simulate human sweating and provide valuable information about heat exchange by evaporation (10) (Burke et al., 1994, Dozen et al., 1989, Meinander, 1992). The most complex sweating manikin is due for year 2000 at EMPA in Switzerland.

All manikins so far have been men and the first female manikin appeared in 1989 (11) (Madsen, 1989). This manikin also provided a new technique for heating and measuring as well as a new regulation concept. An interrupt technique is used to have a single wire for both heating and measuring of each zone. The regulation program uses “comfort” algorithms for the control of the different body segments.

The latest and obviously not the last improvement is the simulation of breathing (Nielsen 2000). This feature is particularly useful in ventilation research.

Other manikins

In parallel with the main manikin development, the same principle for simulation of human heat exchange has been used to construct models for specific applications (Belding, 1949, Kuklane et al., 1997). Thermal foots have been constructed for footwear evaluation. Such models are now in use in several countries. For similar purposes, hand models and head models have been developed. Some of them are able to simulate seating and one of the foot models can simulate walking movements. All manikins so far have been prepared for the adult environment. Several small manikins have been developed for evaluation of the child and baby environment. The smallest one is a 1-kg baby manikin constructed for the evaluation of incubators and other nursing methods for premature babies (Sarman et al., 1992).

Why manikins?

Manikins are complex, delicate and expensive instruments. This is balanced, however, by many advanced and useful features. Table 2 provides a list of arguments for the use of thermal manikins. A human shaped thermal manikin measures convective, radiative and conductive heat losses over the whole surface and in all directions. Depending on number of segments of the manikins surface the spatial resolution can be high. Manikins in use have more than 30 individually regulated segments. By summing up the area weighted values, a value for whole body heat loss is determined.

Table 2. Significant performance features of thermal manikins

-
- *relevant simulation of human body heat exchange*
 - *whole body and local*
 - *measurement of 3-dimensional heat exchange*
 - *integration of dry heat losses in a realistic manner*
 - *objective method for measurement of clothing thermal insulation*
 - *quick, accurate and repeatable*
 - *cost-effective instrument for comparative measurements and product development*
 - *provide values for prediction models*
 - *clothing insulation and evaporative resistance*
 - *heat losses*
-

For the same exposure conditions, a thermal manikin measures heat losses in a relevant, reliable and accurate way. The method is quick and easily standardised and repeatable.

Due to the very nature of the method and measurement, the values obtained can serve directly as input figures for mathematical models for prediction of thermal responses (see Standards below).

Application areas

When the clo-value was defined for thermal insulation of whole clothing ensembles in the early 40's, a method was needed for its determination. The first thermal manikins were constructed in USA for this purpose (Belding, 1949). Extensive clothing research with manikins has been carried out by USARIEM Natick Laboratories (Goldman, 1983), the Hohenstein group (Umbach, 1988) and the Technical university of Denmark (Olesen, Nielsen, 1983). In recent years clothing studies are also done in Sweden (Holmér, Nilsson, 1995), Finland (Meinander 2000), Norway (Holand 2000), Poland (Soltynski et al., 2000), Japan (Tamura Nomiyama, 1994) and China (Zhihua, Yuhang, 2000).

It was early recognised that a heated thermal manikin could also be used for evaluation of the microclimate conditions caused by different ventilation systems (HVAC) (ASHRAE, 1989). This application has increased in recent years, in particular within the automobile industry (Holmér, 1997, Olesen, 1992, Wyon et al., 1985). Recently a European research project analysed and proposed the use of thermal manikins for assessment of vehicle climate. This research was reported at the ATA conference in Florence in November 1999 (Florence ATA, 1999). Manikins are also useful for detailed analysis of room ventilation (Nielsen, Nilsson 2000).

Table 3. Main application fields for thermal manikins

- *Evaluation of clothing*
 - *thermal properties (insulation and evap. resistance)*
 - *protection (fire, radiation, rain ..)*
 - *Evaluation of HVAC-systems*
 - *buildings*
 - *vehicles*
 - *incubators*
 - *Evaluation of indoor air quality*
 - *Simulation of human occupancy*
 - *Physiological simulation*
 - *Other applications*
-

Manikins can simulate any skin temperature distribution, thereby simulating specific thermal conditions of the human body. In this way accurate and precise measurements can be made of total and local heat losses under the given conditions (Chen 1999).

International standards

An increasing number of international standards specify tests with thermal manikins. Most of them deal with the determination of thermal insulation of clothing. A list of standards are given below (Table 4).

Table 4. International standards and thermal manikins

a) describes test method with thermal manikin

-
- *ISO 7920 Estimation of the thermal characteristics of clothing (ISO TC159/SC5/WG1)*
 - *ASTM F1291 Standard method for measuring the thermal insulation of clothing using a heated thermal manikin*
 - *ENV 342 Protective clothing against cold (CEN TC162/WG4)*
 - *EN 511 Protective gloves against cold (CEN TC162/WG8)*
 - *ISO NP 14505 Evaluation of the thermal climate in vehicles, part 1 and 2 (ISO TC159/SC5/WG1)*
 - *EN 345 Safety boots*
 - *EN 397 Safety helmets*
 - *ISO NP Measurement of thermal insulation clothing with a thermal manikin (ISO TC92 WG17)*
-

b) standards requiring value from manikin tests (all by CEN TC159/SC5/WG1)

-
- *ISO-EN 7730 Indoor climate evaluation (PMV and PPD)*
 - *ISO-EN 7933 Required sweat rate*
 - *ISO-TR 11079 IREQ Required clothing insulation*
-

Many evaluation methods and mathematical models for human heat balance require values for thermal insulation and evaporative resistance of clothing. These values, typically obtained from tables describing different clothing systems, have once been derived from measurements with thermal manikins. A remaining problem with some methods is that the clothing values obtained in this way are static, wind still values. Body movements, walking and wind, alone or in combination, modifies (normally reduces) the value, leading to an error in the calculation of heat exchanges. This problem was recently addressed in a European research project correction formulas were derived for use with the revised version of ISO 7933 (Holmér, 1999, Havenith 1999).

Conclusions

The use of thermal manikins in research and standards has significantly increased in recent years. New fields of application such as evaluation of HVAC-systems in rooms and vehicles have grown. Thermal manikins have found their application not only in research but also in test houses and industrial test laboratories.

For research purposes a thermal manikin must provide relevant, reliable and accurate measurements. However, the specific aims and needs of the research problem may require specific design and performance features. The manikins do not necessarily need to be compatible and exactly comparable with other manikins.

For testing purposes the same conditions apply, if the manikin is used for in-house development work. However, as soon as test values need to be compared with values from other laboratories or test houses, the manikin, methods and procedures need to be standardised. Values obtained with different manikins in

different test houses must be comparable and similar within defined limits for the same test conditions. This work has just started within ISO TC92 WG17 (clothing testing) and ISO TC152/SC5/WG1 (vehicle testing).

References

- 6 th International Conference (1999). "The role of experimentation in modern automotive product development process". Florence: *Associazione Tecnica Dell'Automobile, CD-ROM proceedings*. EQUIV Seminar.
- ASHRAE. Physiological Principles, Comfort and Health. (1989) *Handbook of Fundamentals*. ASHRAE, Atlanta, 8.10-8.32.
- Aubertin G, Cornu J-C (1977) *Methode de mesure de l'efficacite de tissus et materiaux composites souples destines a la confection des vetements de protection contre le rayonnement infrarouge*. : INRS, Nancy.
- Behnke WP, Geshury AJ, Barker RL (1990) "*Thermo-man*": *Fulls scale tests of the thermal protective performance of heat resistant fabrics*. International Conference on Environmental Ergonomics IV, Austin, Texas. , 1990: 70-71.
- Belding HS (1949) *Protection against dry cold*. In: Newburgh L ed. *Physiology of heat regulation and the science of clothing*. Pp 351-367, , Philadelphia: Saunders.
- Burke RA, O'Neill FT, Stricker P (1994) *The development of a heat pipe driven manikin with variable flow irrigated skin*. 6th International Conference on Environmental Ergonomics, Montebello, Canada. , 1994: 196-197.
- Chen F, Nilsson H, Holmér I. Evaluation of hand and finger heat loss with a heated hand model. *Appl Human Science* 1999; 18: 135-140.
- Dozen Y, Adachi K, Ohthuki S, Aratani Y, Nishizakura K, Saitoh T, Mizutani T, et al. (1989) *Studies of the heat and moisture transfer through clothing using a sweating thermal manikin*. In: Mercer JB ed. *Thermal Physiology 1989*. Pp 519-524, , Amsterdam: Excerpta Medica.
- Goldman RF (1983) Historical review of development in evaluating protective clothing with respect to physiological tolerance. *Aspects médicaux et biophysiques des vetements de protection, Lyon-Bron. Centre de Recherches du Service de Santé des Armées*, 1983: 169-174.
- Havenith G, Holmér I, den Hartog EA, Parsons K (1999). Clothing evaporative heat resistance-proposal for improved representation in standards and models. *Am OccupHyg* 1999; 43: 339-346.
- Holand B (1999), *Comfort temperatures for sleeping bags*. Proceedings of the Third International Meeting on Thermal Manikin Testing, 3IMM, at the National Institute for Working Life October 12 - 13, 1999. Eds: H. O. Nilsson, I Holmér p26 - 29
- Holmér I (1997) Climate stress in vehicles - a criteria document. *Journal of the Human-Environment System*, 1(1), 23-33.
- Holmér I, Nilsson H (1994) Heated manikins as a tool for evaluating clothing. *Annals of Industrial Hygiene*.
- Holmér I, Nilsson H (1995) Use of heated manikin for clothing evaluation. *Annals of Occupational Hygiene*, 39(6), 809-818.
- Kuklane K, Nilsson H, Holmér I, Liu X (1997) *Methods for handwear, footwear and headgear evaluation*. Proceedings of a European seminar on Thermal Manikin Testing, Solna. Arbetslivsinstitutet, Department of Ergonomics, 1997: 23-29.

- Madsen TL (1989) *A new generation of Thermal Manikins*. : Thermal Insulation Laboratory, Technical University of Denmark.
- Meinander H (1992) *Coppelius - a sweating thermal manikin for the assessment of functional clothing*. Nokobetef IV: Quality and usage of protective clothing, Kittilä, Finland. , 1992: 157-161.
- Meinander H (1999), *Extraction of data from sweating manikin tests*. Proceedings of the Third International Meeting on Thermal Manikin Testing, 3IMM, at the National Institute for Working Life October 12 - 13, 1999. Eds: H. O. Nilsson, I Holmér p96-99
- Nielsen PV (1999), *The Importance of a Thermal Manikin as Source and Obstacle in Full-Scale Experiments*. Proceedings of the Third International Meeting on Thermal Manikin Testing, 3IMM, at the National Institute for Working Life October 12 - 13, 1999. Eds: H. O. Nilsson, I Holmér p89 - 95
- Nilsson H, Holmér I (1997) *Proceedings of a European seminar on Thermal Manikin Testing*. Arbetslivsrapport 97:9, Solna: Arbetslivsinstitutet, Department of Ergonomics.
- Nilsson H, Holmér I, Holmberg S (1999). Indoor Air 99, Edinburgh, 'Comparison between indoor environment measured with thermal manikin and computational fluid dynamics calculation', vol 2, p90-95.
- Olesen BW (1992) *Evaluation of thermal comfort in vehicles during transient and steady state conditions*. Vehicle Comfort. Ergonomic, vibrational, noise and thermal aspects. Vol. 1. Pp 359-369, , Bologna: Associazione Tecnica Dell'Automobile.
- Olesen BW, Nielsen R (1983) *Thermal insulation of clothing measured on a movable thermal manikin and on human subjects*. ECSC Programme Research Nr 7206/00/914, Copenhagen: Technical University of Denmark.
- Sarman I, Bolin D, Holmér I, Tunell R (1992) Assessment of thermal conditions in neonatal care: Use of a manikin of premature baby size. *American Journal of Perinatology*, 9(4), 239-246.
- Soltynski K, Konarska M, Jerzy Pyryt J, Sobolewski A (1999). *Test research of a new generation thermal manikin*. Proceedings of the Third International Meeting on Thermal Manikin Testing, 3IMM, at the National Institute for Working Life October 12 - 13, 1999. Eds: H. O. Nilsson, I Holmér p19 - 23
- Tamura T, Nomiya I (1994) *Effects of wet condition of skin surface on evaporative heat transfer through clothing*. Second International Congress on Physiological Anthropology, Kiel. German Society of Physiological Anthropology, 1994: 334-337.
- Umbach KH (1988) Physiological tests and evaluations models for the optimization of the protective clothing. In: Mekjavic IB, Banister EW, Morrison JB eds. *Environmental ergonomics*. Pp 139-161, , New York: Taylor & Francis.
- Wyon D, Tennstedt C, Lundgren I, Larsson S (1985) A new method for the detailed assessment of human heat balance in vehicles – Volvo's thermal manikin, Voltman. *SAE-Technical Paper Series*, 850042.
- Wyon DP (1989) Use of thermal manikins in environmental ergonomics. *Scandinavian Journal of Work, Environment and Health*, 15 suppl 1, 84-94.
- Zhihua J and Yuhang S (1999). *Standardisation of measuring clothing thermal resistance with thermal manikin*. Proceedings of the Third International Meeting on Thermal Manikin Testing, 3IMM, at the National Institute for Working Life October 12 - 13, 1999. Eds: H. O. Nilsson, I Holmér p13 - 18

Interlaboratory trial of thermal manikin based on thermal insulation of cold protective clothing in accordance with ENV 342

Hannu Anttonen
Oulu Regional Institute of Occupational Health
Oulu, Finland

Introduction

For the evaluation of thermal insulation of cold protective clothing by thermal manikin the working group of ISO/TC38/ - /WG17, decided to arrange inter-laboratory trial. The aim of the measurements was not only to check the repeatability and reproducibility but also to check the effect of varying thermal conditions and the effect of the used calculation models. The interlaboratory trial was organized by Oulu Regional Institute of Occupational Health.

Material and methods

We sent the same kind of clothing ensemble to ten different laboratories in Europe and USA. The ensemble was two-layer clothing system consisting of under-trousers, undershirt, jacket and trousers. Socks and sneakers were to be selected by the individual laboratories. Seven of these laboratories responded to our request of measurements. It was planned that measurement should be done according to the draft of ENV342. It was also expressed that the manikin measurements would be made in the different situation: in standing position and during walking (45 steps/min). Thermal conditions were informed to be 15 °C, 0,4 m/s and 50 % RH. Also the wind of 4 m/s was requested. But only in a few laboratories they could do all these measurements. Also the exact measurement register concerning the test results, manikin and ambient conditions were asked.

Results

The main results are presented in the Figures 1 - 4. So called total insulation value has been calculated by summing up area weighted temperatures and heat losses before calculation. The local insulation has been calculated by summing up all local heat losses weighted by the area factor for the different zones. We also discussed about parallel and serial calculation models.

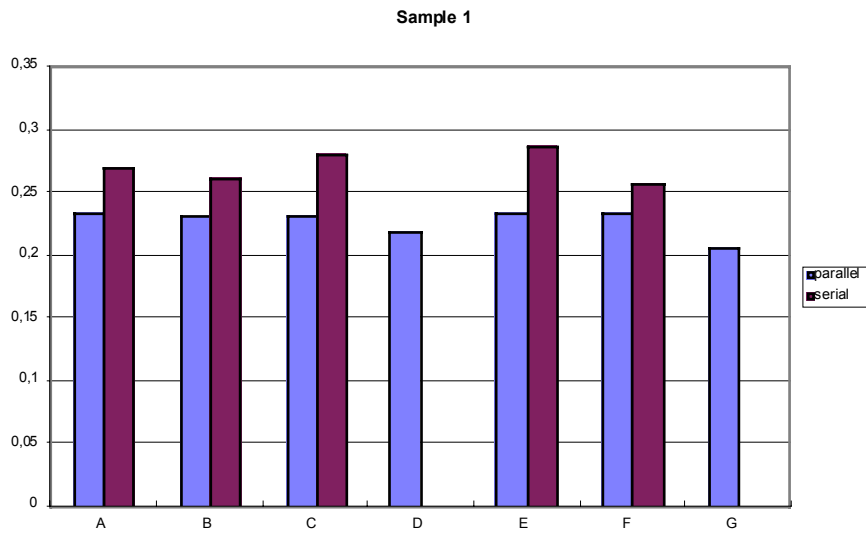

Figure 1. Thermal insulation (m^2K/W) with the *standing* manikin calculated by parallel and serial model (pr ENV342:1995 and 1997)

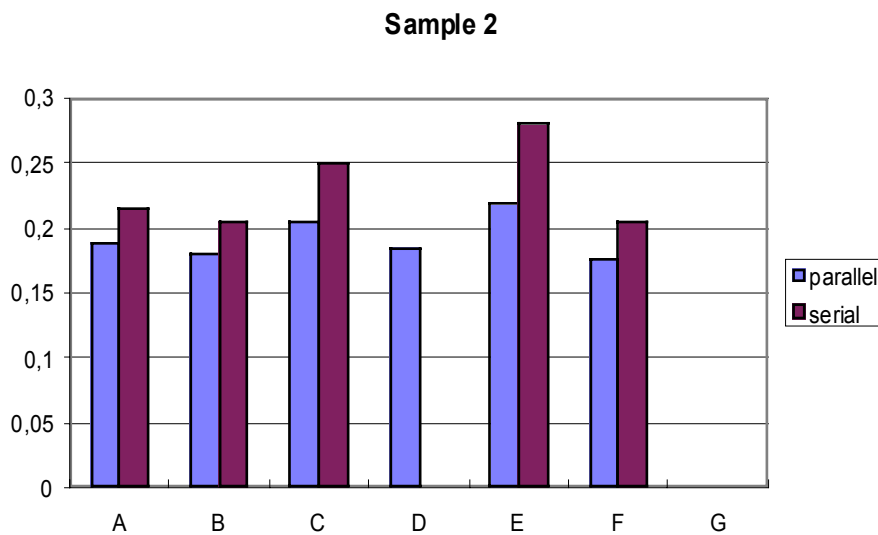

Figure 2. Thermal insulation (m^2K/W) with *walking* manikin (45 steps/min) calculated by parallel and serial model

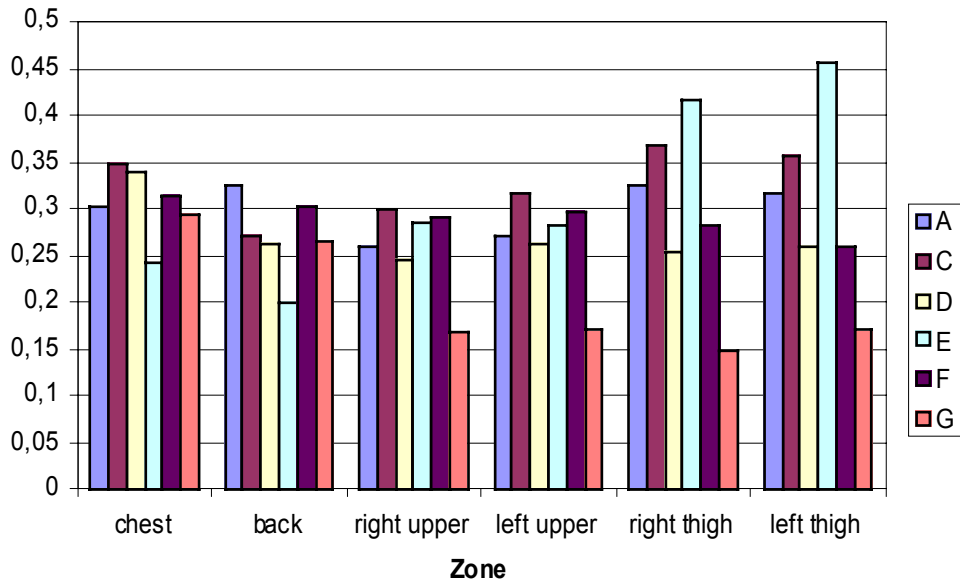

Figure 3. Local thermal resistances (m^2K/W) with *standing* manikin, wind speed 0.4 m/s

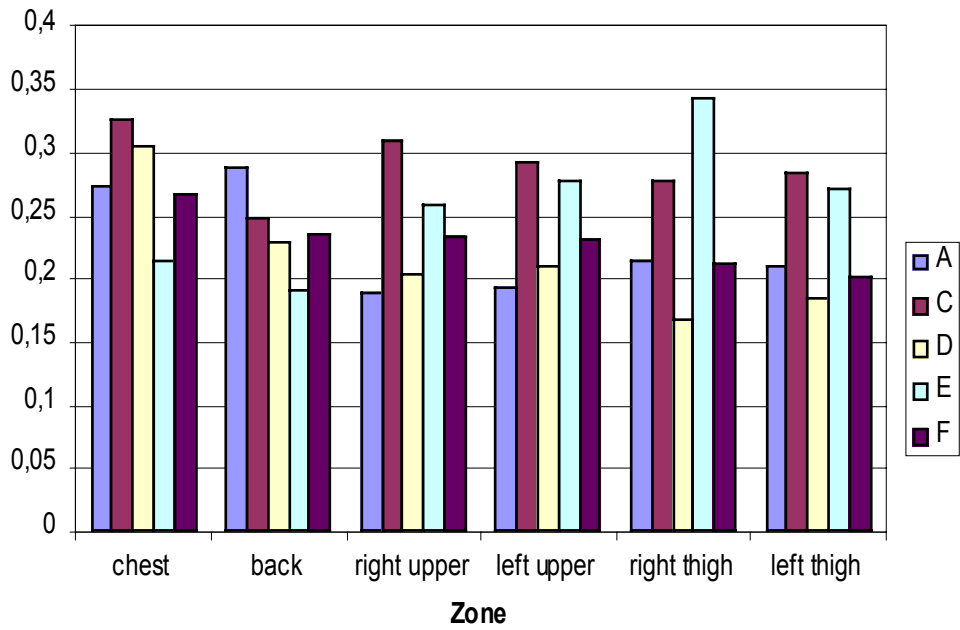

Figure 4. Local thermal resistance (m^2K/W) with *walking* manikin, wind speed 0.4 m/s

Discussion and conclusion

The general mean of measurement calculated by parallel model in the basic conditions was 0,226 (range 0,207 - 0,234 m^2W/K) and standard deviation in different laboratories 0,006 m^3K/W . Repeatability variance were $30 \cdot 10^{-6}$, between laboratory variance $117 \cdot 10^{-6}$ and reproducibility variance $147 \cdot 10^{-6}$. By the serial model the results were 0,268 m^2K/W , s.d. about 0,004 m^2K/W . The effect of

walking ranged from 0,056 to 0,022 m²K/W and the effect of wind from 0,11 to 0,10 m²K/W. Also the effect of clothing size was equal about 0,01 m²K/W.

The thermal insulation of local section ranged from 0.027 to 1.254 m² K/W. The standard deviation of local thermal insulation varied from 0.001 to 0.055 m² K/W, which was higher compared to s.d. of total insulation. On average the s.d. was about 0.015 m² K/W. The range of standard deviation were independent of walking, wind speed or size of clothing ensemble in general.

The thermal insulation of local zone, even with a small area (bottom, part of thigh) had a strong effect on the thermal insulation, $I_{t,r}$, of manikin when using serial (local) model in calculation. The differences in local values were higher than total thermal insulations between laboratories, even 30 %. However local differences between right and left side (arm, thigh) were small. Walking and wind made the differences a little bit smaller in torso. The result related more or less to the properties of manikin. The results are fairly good in the different labs, but using the serial calculation model the differences were higher. Hence the good practice could be to use the serial model for checking the accuracy of the total value usually given to the customers.

The effect of the change in the wind speed in lower wind velocities can be larger, especially in the case of high air permeability, but in the higher wind velocities the error affect much less. This can be seen from the slope of the curve relating to the insulation in different wind velocities.

Standardisation of measuring clothing thermal resistance with thermal manikin

Jiang Zhihua and Shen Yuhang
The Quartermaster Research Institute
Beijing, China

Introduction

Since 1940's, thermal manikin testing technology has been developed and applied in measurement and assessment of clothing thermal resistance(insulation) in many countries such as the US, Germany, Japan, Canada, Denmark and Finland. In China, the Quartermaster Research Institute (QRI) began to develop this technology in 1978. There is no doubt that such a technology is a remarkable achievement to improve the quality and the efficiency of clothing research and design. However, thermal manikins developed by different countries are of different characteristics. The difference in material, shape, structure of divided parts, method of temperature control and testing conditions has brought about different testing results. It has limited application of thermal manikins and caused difficulties in academic exchange and testing result comparison. Scholars from different countries in this field share the desire to study and solve the problem of standardization of thermal manikin testing system. We would like to put forward our ideas for discussion in order to achieve common understanding in standardization of thermal manikin testing and promote this kind of technology to further development. The object of study in this paper is a dry (non-sweating) thermal manikin and its application in measuring clothing thermal insulation (clo value) at constant temperature.

Examination indexes of thermal manikin system

Thermal manikin is a kind of general instrument. If we want to standardize thermal manikin testing system, we should have a generally-accepted examination indexes to evaluate the system. These indexes should include various aspects, among which the most important are accuracy, repeat precision and testing range.

Accuracy

How to examine the accuracy of thermal manikin system? According to the requirement of "tracing the source" in instrument measuring standard, thermal manikin testing results should be related to an international standard and accepted by most scholars in the world. But at present there is no such a kind of international standard. Gagge.A.P. and two other scholars defined the equation and thermal manikin testing conditions in 1941 when they determined the clothing

insulation unit (Gagge.A.P and Burton.A.C, 1994). If this earliest definition is regarded as a generally-accepted basis to examine the accuracy of thermal manikin testing system, one of the most important conditions is to have a set of clothing whose clo value is 1. In fact, it is very difficult to do so and the result may be controversial even if it could be done because the shape of manikins is different from one country to another. We have come to an idea that in the earliest definition there is an insulation value of clothing surface air layer besides 1 clo. The value equals to 0.78 clo, which can be achieved by nude thermal manikin testing. We can define an accepted deviation range(e.g. ± 0.03 clo) and examine the accuracy of manikin system by comparing nude manikin testing results with the earliest value. In this way, there is no trouble of getting the 1 clo clothing. According to this hypothesis, a series of nude manikin testing have been conducted with our own thermal manikin system at constant skin temperature of 33 °C, no wind, environment temperature varying from 6 °C to 24 °C (Yang Tingxin and Wu Zhixiao, 1996). The results are shown at Table 1.

Table 1. Nude thermal manikin testing results

Times Groups		1	2	3	4	5	6	Mean	Stddev	CV%
		A	$T_a(^{\circ}\text{C})$	6.08	6.11	6.16	6.21	6.24	6.27	6.178
	$I_q(\text{clo})$	0.68	0.70	0.69	0.69	0.70	0.69	0.692	0.008	1.16
B	$T_a(^{\circ}\text{C})$	7.67	7.66	8.49	8.67	9.25	9.00	8.460	0.670	7.92
	$I_q(\text{clo})$	0.70	0.70	0.70	0.70	0.70	0.70	0.700	0.000	0.00
C	$T_a(^{\circ}\text{C})$	12.61	12.65	12.67	12.87	13.95	14.24	13.170	0.738	5.60
	$I_q(\text{clo})$	0.72	0.72	0.71	0.72	0.72	0.72	0.718	0.004	0.56
D	$T_a(^{\circ}\text{C})$	16.23	16.76	16.69	17.23	17.56	18.00	17.078	0.644	3.77
	$I_q(\text{clo})$	0.72	0.72	0.73	0.74	0.73	0.73	0.728	0.008	1.10
E	$T_a(^{\circ}\text{C})$	21.58	21.61	21.81	22.02	22.13	22.60	21.958	0.382	1.74
	$I_q(\text{clo})$	0.77	0.78	0.77	0.78	0.79	0.77	0.777	0.008	1.03
F	$T_a(^{\circ}\text{C})$	23.81	23.74	24.26	24.26	24.36	24.52	24.158	0.313	1.30
	$I_q(\text{clo})$	0.78	0.79	0.78	0.78	0.79	0.80	0.787	0.008	1.020

The result shows that the nude insulation values change slightly and regularly with the environment temperature. Its correlation coefficient r is 0.976. Its regression equation is $I = 0.653 + 0.005 \cdot T_a$. According to this formula, the clo value of nude manikin surface air layer is 0.77 clo when standard skin temperature (T_s) is 33 °C and standard environment temperature (T_a) is 21 °C.

The calculation above shows that the clo value of nude manikin surface air layer is 0.77 clo under standard conditions by use of the thermal manikin developed by the QRI. The difference between this value and the earliest value (0.78 clo) is 0.01 clo. So it can be inferred that the thermal manikin testing system developed by the QRI can meet the measuring requirement of clothing insulation. Meanwhile, it is suggested that to measure the air layer insulation by different thermal manikins should be done under standard conditions of the earliest value (0.78 clo). The result will be approaching 0.78 clo and measuring deviation should be under(or equal to) ± 0.03 clo.

It is easier and more convenient to measure clo value with nude manikin than with dressed manikin. Firstly, manikin's shape, clothing structure & size will not affect testing result. Secondly, the influence caused by clothing factors (e.g. High insulation clothing is likely to make human body create heat storage) can be avoided, which makes the testing result to be more accurate. This is because the manikin insulation testing is a heat balance experiment and the heat exchanges thoroughly under the nude. Thus, the air layer clo value measured with a nude manikin should be regarded as a basic part of the testing standard, and the value should be regarded as one of the standards to measure clo value.

Repeat precision

The repeat precision of instrument in the same experiments is one of the most important symbols to characterize the system's reliability. There is no exception for the measurement of clothing clo value with thermal manikin. According to international practice, the coefficient of variation (CV%) is used to judge results of repeated testing (given as percentages). In order to examine precision of the system, four clothing ensembles have been tested on thermal manikin for many times. The results show at Table 2. We carried out the analysis of variance, calculated the standard deviation of random error and coefficient of variation of the datum shown at Table 2. The results indicate that the discrete differences of the clo values of the same ensemble are all in the range set by us, i.e. the coefficient of variation is under 2%.

Table 2. Repeat precision testing results in ensembles (unit: clo)

Times	The first ensemble	The second ensemble	The third ensemble	The fourth ensemble
1	2.48	2.84	3.73	4.54
2	2.49	2.87	3.74	4.58
3	2.46	2.87	3.77	4.64
Mean	2.48	2.86	3.75	4.59

Testing range

The testing range is another important symbol for testing capability of the system. In the process of testing anti-cold clothing with thermal manikin, the thicker the ensembles, the more difficult to test. Therefore, an upper limit should be given for clothing insulation measured with thermal manikin. Otherwise, we can not get the correct value when the ensemble insulation is too high. Of course, all these should be based on practical needs. There is no significance in wearing the ensembles whose insulation is too high. We should put it in an appropriate and practical way.

We once measured large anti-cold ensembles with clo value higher than 6.0 clo. In fact, few people need such ensembles. According to our experience, it is suitable to set the upper limit at 6.5 clo for clothing insulation measured with thermal manikin.

In order to promote the application of thermal manikin testing technology, it is necessary to compare testing results among labs of different countries besides applying some accepted examination indexes in experiments. By doing so, all of us can learn from others' strong points to offset one's weakness and benefit from others experience.

Factors affecting results

1. Central temperature inside manikin

The measurement of clothing insulation with thermal manikin is a dynamically balance adjustment process. It means that continuous adjustment of heat flux makes the manikin skin temperature approach a constant temperature gradually under the heat diffusion. The final state is that the manikin skin temperature is steady in a narrow range and very close to the constant temperature. At the same time the change of heat flux is also steady in a narrow range. In such a steady period we can calculate the clo value based on the heat flux and the difference between the mean skin temperature (T_s) and air temperature (T_a). But the premise for such calculation is that the heat diffusion is in one direction.

In practice it is very difficult to achieve the result. We have found that morning testing result of the same ensemble is lower than the afternoon testing result. By analysis, we think that the heat storage inside the manikin is different from morning to afternoon. In the morning, the heat inside manikin is not stored fully. During the balance period, there is still a little heat energy diffusing into the body. So the clo value measured in the morning is lower than that in the afternoon. Later, we installed a temperature sensor in the center of manikin as a temperature reference point. The testing result has proved that our analysis is correct. Our control process of thermal manikin testing system can be divided into three stages.

Temperature rising stage

The task of this stage is to make the manikin skin temperature of all parts rise rapidly and steadily to the constant temperature and maintain the temperature within a range of ± 1 °C around the constant temperature so as to avoid high deviation.

Temperature adjusting stage

The task of this stage is to make the change of the manikin skin temperature of all parts converge at the range of ± 0.5 °C around the set temperature and make the range tend to reduce gradually through flux adjustment and continuous control. In this stage, the control of heat flux must match the expected change of skin temperature. The phenomenon of "equal amplitude oscillation" and "diffusion oscillation" also must be avoided.

Balance stage.

Through further adjustment and control, the skin temperature change of all parts approaches steadily the narrow range around the set temperature. The set balance range is ± 0.2 °C around the constant temperature and is on the trend to reduce

gradually. At the same time, the central temperature of the thermal manikin is getting closer to the set skin temperature. With all such essential conditions achieved, the system gets into the balance stage. After a while, we can calculate testing results according to all the balance parameters and print them out.

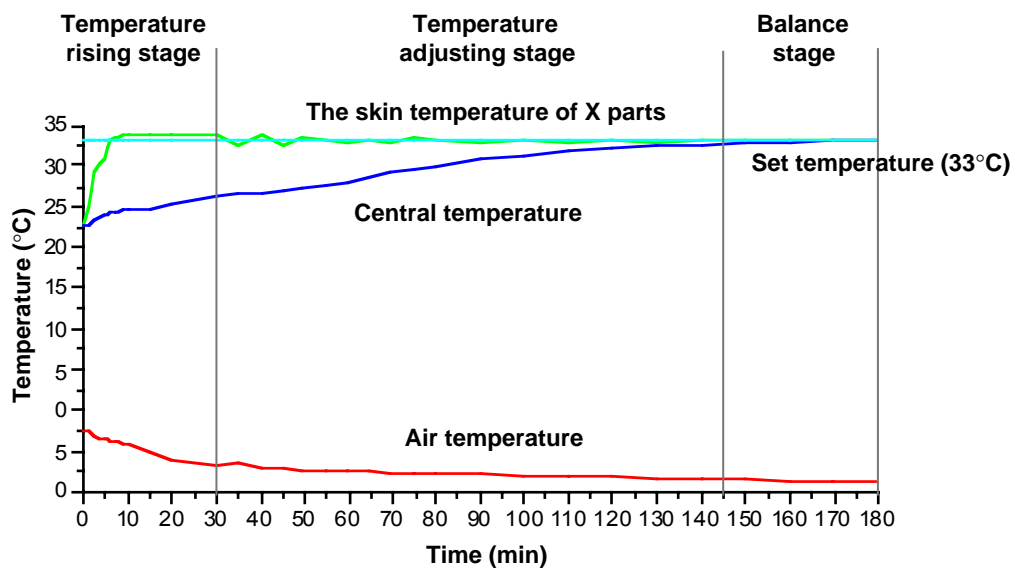

Figure 1. The skin temperature adjusting and control process of X parts of thermal manikin

The skin temperature adjustment and control procedures mentioned above are shown at Figure 1. From Figure 1, we can see that the central temperature of the thermal manikin rises continuously to the set value along with continuous adjustment and control of the skin temperature. When the central temperature approaches the set value, the heat flux is one way totally for heat diffusion. So we can control the time to get into balance by controlling the central temperature. When the central temperature is near the set value, the thermal manikin gets into balance. In this way the error caused by the internal heat storage or heat loss can be eliminated.

2. Match of air temperature

In all of the testing conditions, the choice of air temperature must be taken into consideration although it does not need to be so precise as other conditions. Otherwise, if a small temperature difference ($T_s - T_a$) is adopted when the predicated insulation of clothing is very high, or if a big temperature difference is adopted when the predicated insulation of clothing is very low, the accuracy of testing results would be affected. As for this, we have taken the method as follows:

By controlling the temperature difference ($\Delta T = T_s - T_a$), we choose the suitable air temperature according to the predicated insulation (I).

when	nude	$\Delta T \geq 10 \text{ }^\circ\text{C};$
when	$1 \text{ clo} \leq I \leq 4 \text{ clo}$	$30^\circ\text{C} \leq \Delta T \leq 40 \text{ }^\circ\text{C};$
when	$I \geq 4 \text{ clo}$	$40^\circ\text{C} \leq \Delta T \leq 60 \text{ }^\circ\text{C}.$

3. Fitness of clothing

The fitness of clothing will directly affect testing results. So we should stipulate the fitness of ensembles. Otherwise, it will affect the correct assessment of clothing, particularly comparison of clothing made of different materials.

Our general requirement is that the fitness of clothing should conform to related wearing standards of clothing size. The fitness of clothing for different ensembles should be the same when undertaking comparison testing.

Conclusions

The results indicate that:

- a) The air layer insulation value(0.78 clo) of nude thermal manikin should be regarded as one of the important examination indexes in order to standardize thermal manikin testing system, meanwhile the repeat precision and testing range should also be defined.
- b) In order to get the correct testing results with thermal manikin system, the heat energy must be diffused in one direction. We should choose the environment condition according to predicated clothing insulation values. At the same time, the fitness of clothing should be considered as well.

References

- Gagge.A.P and Burton.A.C (1994). *Science* 1994, p428
Yang Tingxin and Wu Zhixiao (1996) *Research on thermal insulation of clothing*, Human Ergonomics, 1996. 3, Vol 2

Test research of a new generation thermal manikin

Krzysztof Soltynski, Maria Konarska, Jerzy Pyryt, Andrzej Sobolewski
Central Institute for Labour Protection
Warsaw, Poland

Introduction

Many models and indices for predicting comfort or thermal stress make use of the value of the insulation of the clothing worn in a specific situation. Normally, this insulation value is unknown and has to be determined usually on humans, but more often on thermal manikins. For the same clothing ensemble the insulation value determined on humans was generally found to be lower than the corresponding value determined on a manikin, with no satisfactory explanation of the observed differences. Our ultimate objective is to confirm and test this effect. The present work – testing a new thermal manikin with respect to using it for the measurement of thermal insulation of clothing – is only the initial phase in the realisation of this task.

Methods

Garments

Four clothing ensembles were selected for this study:

Ensemble A - shoes, socks; underwear, briefs and a shirt (cotton); surgical ensemble (cotton-like nonwoven with hydrophobic viscose fibres, material square metre weight [sq] = $65 \text{ g/m}^2 \pm 7$, good permeability of air and water vapour).

Ensemble B - Ensemble A plus a surgical apron (hygienic foil-covered two-layer nonwoven made of fibres and polypropylene foil, material square metre weight [sq] = $45 \text{ g/m}^2 \pm 2$), not permeable to any liquids).

Ensemble C - Ensemble A plus a surgical apron (thermoplastic two-layer hygienic nonwoven made of propylene fibres and hydrophilic viscose fibres, material square metre weight [sq] = $35 \text{ g/m}^2 \pm 2$, good permeability of air).

Ensemble D - Ensemble C plus a surgical cap (thermoplastic hygienic nonwoven made of 100% propylene fibres, material square metre weight [sq] = $20 \text{ g/m}^2 \pm 2$). The ensembles (Figure 1) were chosen as typical medical work clothing, made according to the WHO recommendations and the requirements of ISO 9001 and EN 49000.



Figure 1. Clothing ensembles selected for this study.

Thermal manikin

The clothing insulation of the tested ensembles was determined using a thermal manikin type TM3 (made in co-operation with the Thermal Insulation Laboratory, Technical University of Denmark). The measurements were performed according to ISO 9920 (Figures 2, 3).

Posture and movements

One posture and one movement type were tested: rest in standing posture.

Wind

One wind condition was tested: no wind (air speed ≤ 0.1 m/s). That is why all the experiments were performed in a climatic chamber.



Figure 2. An experiment stand intended for testing clothing insulation of a nude manikin resting in standing posture. Determination of I_a



Figure 3. An experiment stand intended for testing clothing insulation of a clothed manikin resting in standing posture. Determination of I_T

Experimental procedure

I_a, I_T test

The experiments were carried out in a climatic chamber in which air (T_a) and mean radiant temperature (T_r) were maintained to within 0.1 °C. Relative humidity was kept constant at 40±5 % and air velocity at 0.1±0.03 ms⁻¹.

Two series of experiments were performed:

In series I (nude manikin), I_a dependence was determined for various values of (T_{ms} – T_o) and for various values of H. There was a total of 12 experimental sessions. Each session lasted about 4 hours.

In series II (clothed manikin), I_T insulation was determined for the clothing ensembles selected for this study. During the experiments the operating temperature in the climatic chamber was kept constant at 23.5±0.1 °C. There was a total of 21 experimental sessions. Each session lasted about 4 hours. During this period all measurements were performed every second and recorded as minute averages. The measurements were also continuously displayed graphically, enabling an easy check of the steady situation.

Recovery time test

Set the climatic chamber to 24 °C; Start manikin naked in comfort mode and log file every minute; Wait for steady state; Switch off heat; After 3 minutes switch on heat; Wait for steady state.

Calculations

Insulation

Total insulation, I_T (in m²·°C/W), is the insulation from the surface of the manikin to the environment, including the effect of the increased surface area, f_{cl}, and the resistance on the surface of the manikin, I_a.

$$I_T = \frac{\bar{T}_{cms} - T_o}{H}$$

where: \bar{T}_{cms} = mean manikin surface temperature, in °C; T_o = operating temperature, in °C; H = heat loss from clothed thermal manikin, in W/m².

Surface air insulation (I_a) and effective clothing insulation (I_{cle}) can be similarly calculated:

$$I_a = \frac{\bar{T}_{nms} - T_o}{H} \quad I_{cle} = \frac{\bar{T}_{cms} - T_o}{H} - I_a$$

One clo units equals a resistance of 0.155 m²°C/W.

Statistics

A statistical package STATGRAPHIC and analysis of variance were used to determine the effects of the parameters under investigation on insulation values.

ANOVA was used to test differences between separate levels of significant parameters. A significance level of $\alpha = 0.05$ was accepted.

Results

The results of the manikin measurements are presented in table 1. The insulation of the surface air layer of the manikin amounts to 0.78 clo.

Table 1. Mean values and standard deviations of total (I_T) and effective (I_{cle}) insulation for the four ensembles as measured on the standing manikin at air velocity ≤ 0.1 m/s

Ensemble	I_T		I_{cle}	
	(m ² K/W)	(clo)	(m ² K/W)	(clo)
A	0.206 ± 0.001	1.33 ± 0.01	0.084 ± 0.001	0.54 ± 0.01
B	0.218 ± 0.002	1.40 ± 0.01	0.096 ± 0.002	0.62 ± 0.01
C	0.269 ± 0.001	1.74 ± 0.01	0.147 ± 0.001	0.95 ± 0.01
D	0.266 ± 0.003	1.72 ± 0.02	0.144 ± 0.003	0.93 ± 0.02

Table 2. Mean values and standard deviations of air temperatures (T_a), globe temperatures (T_g), operative temperatures (T_o), manikin surface temperatures (T_{ms}) and dry heat loss (H) observed during experiments

Observed experimental conditions (clothed manikin)					
Ensemble	T_a (°C)	T_g (°C)	T_o (°C)	T_{ms} (°C)	H (W/m ²)
A	23.6 ± 0.1	23.6 ± 0.1	23.6 ± 0.1	33.7 ± 0.1	49.2 ± 0.4
B	23.4 ± 0.1	23.4 ± 0.1	23.4 ± 0.1	33.8 ± 0.1	47.7 ± 0.4
C	23.7 ± 0.1	23.5 ± 0.1	23.6 ± 0.1	34.3 ± 0.1	39.8 ± 0.2
D	23.6 ± 0.1	23.5 ± 0.1	23.5 ± 0.1	34.2 ± 0.1	40.2 ± 0.3

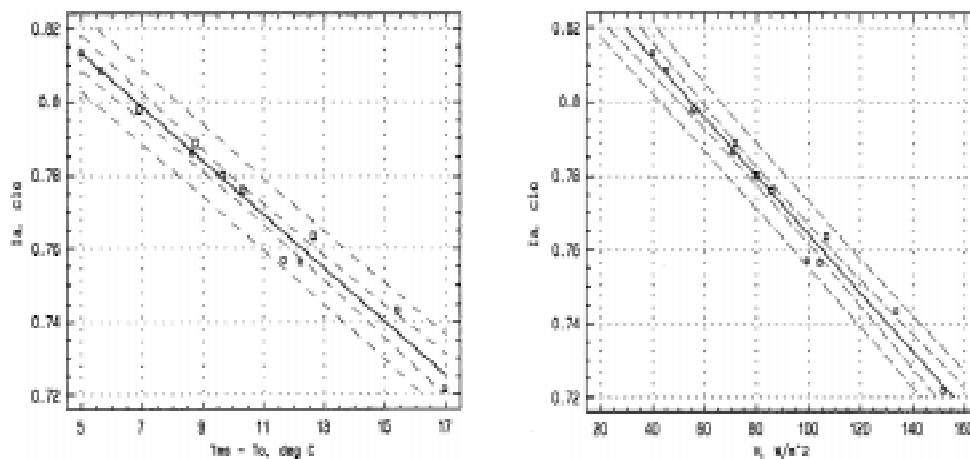

Figure 4, 5. The relationship between surface resistance (I_a) and various values of ($T_{ms} - T_o$) of H observed in experiments with a nude manikin. Dotted lines show confidence and prediction limits

Discussion

The relative measurement error of clothing thermal insulation (I_T) treated as an error of the complex value is approximately 3 %. The partial input of particular measured values is as follows: operating temperature measurement error (T_o) – 56 %, manikin surface temperature (T_{ms}) – 35 % and heat loss from manikin surface (H) – 9 %. The relative error assessed on the basis of the measurements does not exceed 2 %. Thus, the role of the climatic chamber is important for these measurements. Manikin recovery time assessed according to the test is approximately 14 minutes, time constant is approximately 4 minutes. The number of necessary measurements assessed on the basis of the average variance of results for estimate precision of 0.01 clo is $n = 11$, and for 0.02 clo it is $n = 3$. Therefore, for testing clothing in practice it is sufficient to repeat measurements three times for one tested ensemble. The differences between the average values for ensembles are statistically significant (ANOVA, $F = 1000$). The case of ensembles C and D is especially interesting. The lower value of I_{cle} for ensemble D, despite the addition of a cap, has been caused by hiding the manikin's hair inside the cap. This automatically results in parts of the body previously covered by hair (neck, cheeks) being no longer covered.

References

- Nishi, Y., Gonzalez, R. R., and Gagge, A. P., 1975, Direct measurement of clothing heat transfer properties during sensible and unsensible heat exchange with thermal environment. *ASHRAE Transactions*, 81, 183-199.
- Olesen, B., Sliwinka, EE., Madsen, T., and Fanger P. O., 1982, Effect of body posture and activity on the insulation of clothing. Measurement by a movable thermal manikin. *ASHRAE Transactions*, 32, 791-805.
- Vogt, J. J., Meyer, J. P., Candas, V., Libert, J. P., and Sagot, J. C., 1983, Pumping effects on thermal insulation of clothing worn by human subjects. *Ergonomics*, vol. 26, No. 10, 963-974.
- Havenith, G., Heus, R., and Lotens, W. A., 1990, Resultant clothing insulation: a function of body movement, posture, wind, clothing fit and ensemble thickness. *Ergonomics*, vol. 33, No. 1, 67-84.
- Parsons, C. K., 1988, Protective clothing: heat exchange and physiological objectives. *Ergonomics*, vol. 31, No. 7, 991-1007.

Manikin needs in sport field

Hayet Sari
Service Recherche Avancée, DECATHLON Campus
Villeneuve d'ascq, France

Introduction

Nowadays, sports enthusiasts are informed about sport goods performances they need and aspire to products, which answer their demand. Their demands concerning clothing are appropriate thermal insulation and the body sweat evacuation. The same needs affect sport accessories as bicycle helmets, tents and sleeping bags.

Sport goods manufacturers desire is to satisfy the consumers increasing demands. The products they propose are continually improved in term of comfort and security. However, industrials need tools to evaluate, to classify and to guarantee the heat performance of their product and also the sweat management by ventilation, breathable component or their absorption properties. Testing the products on human is tricky and Manikin seems to be the best way for such measurements.

Manikin needs in sport field:

- Movable hand and foot: to simulate hand and foot movements during sport activity and allow assessment of the ventilation performance of gloves and shoes.
- Movable manikin: instrumented manikin technology required is that evolved to a level that permits assessment of the thermal performance of materials and garments in realistic simulations of sport practice.
- Sweating hand and foot: for simultaneous measurements of thermal insulation and water vapour transmission of gloves and shoes.
- Sweating head: for simultaneous measurements of thermal insulation and water vapour transmission by ventilation of helmets.
- Sweating manikin: for simultaneous measurements of thermal insulation and water vapour transmission of clothing ensembles or sleeping bags.
- Submersible manikin: for measurement of diving suits insulation function of depth.

Conclusion

A large number of different sport products could be tested but it is not probably possible because of high resulting cost. Generally sport companies do not intend to spend money on sophisticated manikin but they would probably agree to pay for easily manageable, less expensive and less complicated tools. Manufacturers want to be completely independent to carry out their own tests and to avoid subcontracting with their research.

It is worthy to understand well the manikin tests and the use of manikin to evaluate and improve the thermal comfort performance of material and garments. The tests and the results of the tests should also be clear enough to be understood by consumers; rationale information should be given to them so as to make possible to anyone to know the thermal performance of the proposed item and to allow the right choice in their purchase.

At the present time, the tendency is to manufacture sophisticated and expensive manikins in order to approach the human behaviour. Are manikins the best solution in our case? Could we consider :

- to limit the manikin use only for comparing product performances.
- to maintain human experiments for qualitative tests and comfort assessments.

In this case human experiment should also be standardised.

Comfort temperatures for sleeping bags

Bård Holand
Extreme Work Environment, SINTEF Unimed,
Trondheim, Norway

Introduction

SINTEF Unimed's thermal manikin (produced at the Technical University of Denmark) has been used for several years to test sleeping bags both for end users and for manufacturers. These tests have been performed both to reveal insulation values (performance) and as a tool in product development (design and material selection).

For years sleeping bag manufacturers have indicated thermal limits for their bags, often based upon a mixture of intuition and experience. Professional users (e.g. the military) however, often require documentation to accept ratings. In order to provide that, SINTEF Unimed has performed a number of tests where we have compared insulation measurements of different sleeping bags with subjective evaluations done by personnel under laboratory conditions for the same bags. Based on these comparative tests, we have established a preliminary model to calculate expected minimum environmental temperature for comfortable sleep based on measured Clo-values for the sleeping bag. Our calculation model is based on the IREQ formula described in ISO Technical Report 11079 with certain assumptions. We have arrived at the following formula to calculate minimum environmental temperature for comfortable sleep in a sleeping bag based on the measured Clo-value:

$$\text{Comf.temp.} = -7.8473 \cdot (\text{Clo-value}) + 30.078$$

Background

Through several years SINTEF Unimed has repeatedly been approached by Norwegian sleeping bag manufacturers who wanted their products evaluated through objective measurements. In addition to getting measurements, they focused on how this information should be presented to the end users of their products. At present only a tiny minority would find a "Clo-value" printed on the declaration tag meaningful. We suggested therefore, that they should focus on under which ambient conditions a specific sleeping bag would provide comfortable sleep. To do that, it was necessary to know under which ambient temperature a sleeping bag with a measured Clo-value would provide comfortable sleep. To achieve such data, a project was performed where human test subjects slept in bags with known thermal insulation values under controlled conditions in our laboratories. Based on thermal monitoring of the subjects in addition to subjective evaluation, our aim was to achieve a correlation between

measured sleeping bag insulation and subjective feeling of thermal sleeping comfort.

Methods

A total number of 7 different types of sleeping bags, one military type and 6 commercial bags produced by two different manufacturers, were tested. First all 7 bags were tested on our thermal manikin in order to establish the thermal insulation value. Our manikin is a female type, produced in Denmark. It is 168 cm tall, and consists of 16 body elements. The weight of the manikin is approximately 35 kg. The commercial bags were all designed for persons with a body length up to 180 cm, while the military type was expected to be used by personnel up to 195 cm.

The manikin was placed naked inside the bag, and the bag including the manikin, was placed on a foldable camping bed with a 10 mm thick field mattress (used by the military) between the sleeping bag and the bed. The temperature inside the climatic chamber was adjusted in order to achieve a total heat loss from the manikin between 40 and 80 W/m² (normally around 55 W/m²) when the system thermally ended up in a steady state with the environment. The manikin was set up to operate in *comfort mode* (dry heat loss) according to the Fanger equation (Fanger P.O., 1970).

The Clo value was calculated based on a serial model (prEN 342, 1995), and the final value was calculated based on the average of two independent measurements as long as the two measurements did not differ more than 5% (which they never did).

Table 1. 6 male and 6 female test subjects participated in the subjective evaluation. Their age, height and bodyweight were as follows

	Average age	Average height (cm)	Average weight (kg)
Women	24 (±2.4)	173.6 (±9.5)	67.8 (±7.9)
Men	28.2 (±7.8)	179.5 (±7.6)	82.3 (±14.8)

The tests were carried out in our climatic chambers where the temperatures were set according to the expected lower limit for comfortable sleep for the different sleeping bags. The tests lasted from 23:00 in the evening until 06:00 the next morning. Rectal temperature and 6 skin temperatures were recorded every 10 minutes during the test. The test subjects wore a minimum of underwear, and used the same bed and mattress as described for the thermal manikin except for temperatures at -15 °C or lower, where they were allowed an extra mattress. At these low temperatures they were also allowed to wear a balaclava to better protect their head.

The test subjects were allowed to abort the test at any time if they were not able to sleep due to thermal discomfort. In such cases the subjects repeated the test with that specific sleeping bag, at modified temperatures until their subjective minimum comfortable temperature for that sleeping bag was established. Immediately after termination of the test in the morning, the subjects were asked

to give a subjective evaluation based on their experience during the test. In the questionnaire they had to answer, they were asked questions like:

- Did you wake up during the night due to thermal discomfort?
- How would you rate your thermal comfort?
- What is your estimate of the lowest comfortable temperature for the actual sleeping bag?

Results

The measured Clo-values and the corresponding average minimum environmental temperatures for comfortable sleep are summarized in Table 1 for the 7 different sleeping bags that were evaluated.

Table 2. Data evaluated for the different sleeping bags

Bag no.	Clo-value	Subjective min. temp (°C)
1	3.7	5
2	4.4	-6
3	4.9	-10.5
4	5.8	-14.3
5	6.1	-18.5
6	6.3	-16.3
7	7	-22

The calculation model

To predict the minimum temperature expected for comfortable sleep for a sleeping bag with a given Clo-value, we used a calculation model presented in ISO Technical Report 11079 (ISO Technical report 11079, 1992). This model allows us to calculate required insulation, IREQ and duration limited exposure, DLE (first choice in an accompanying program). The following parameters were used:

Metabolic energy production:	55 W/m ²
Rate of mechanical work:	0 W/m ²
Mean radiant temperature:	= Ambient air temperature (°C)
Air velocity:	0 m/s
Relative humidity:	60 %
Available basic clothing insulation (I _{cl}):	= Measured insulation value (Clo)

The ambient air temperature that we defined as the minimum temperature for comfortable sleep, was the temperature that in conjunction with the parameter setting above, gave a "Duration limit exposure" (DLE_{neutral}) = 8 hours.

By repeating these calculations for a number of Clo-values, we ended up with the following equation in order to predict a minimum temperature for comfortable sleep (Comf.temp.) for a sleeping bag, based on a measured thermal insulation value (Clo):

$$\text{Comf.temp.} = -7.8473 \cdot (\text{Clo}) + 30.078$$

Conclusion

Figure 1 below shows a comparison between the calculated comfortable temperatures vs. thermal insulation values (solid line) and the average subjective evaluations of minimum temperature for comfortable sleep for 7 different sleeping bags with known thermal insulation.

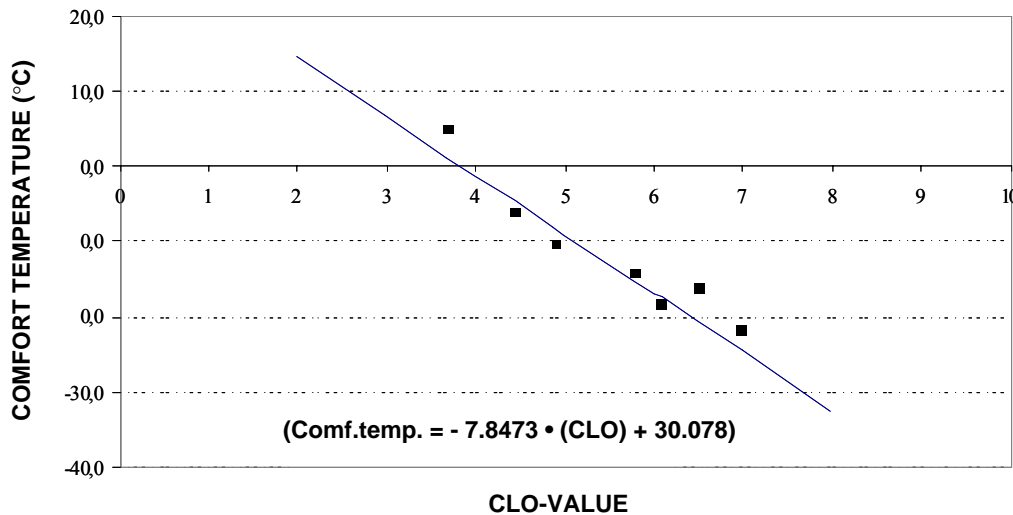

Figure 1. Minimum expected ambient temperature for comfortable sleep in a sleeping bag with a given thermal insulation *Solid line:* Calculation model ($\text{Comf.temp.} = -7.8473 \cdot (\text{Clo}) + 30.078 \text{ } ^\circ\text{C}$) *Squares:* Results from subjective evaluations

Although the comparison in Figure 1 between the subjective and the calculated results is fairly good, one should bear in mind that the calculation model used, suffers from at least one potential source of error. The Clo-value represents an average value over the whole body, which means that any local cold spots will not be considered per se. Most people who have slept in a sleeping bag under cold conditions, may have experienced that such cold spots (e.g. cold feet) may be a significant reason for thermal discomfort and consequently poor sleep. This may well explain why sleeping bag No. 6 was rated at a higher temperature during the subjective tests than bag No. 5, despite of a higher Clo-value for bag No. 6.

References

- Fanger P.O. (1970) *Thermal Comfort*, Danish tech. press, Copenhagen 1970
 ISO Technical report 11079 (1992) "*Evaluation of cold environments –Determination of required clothing insulation IREQ*". (Jan. 1992)
 prEN 342: (1995), Annex B, (B7) Page 12 Equations (1), (2), (3) and (4).

Use of a thermal manikin for prediction of local effects of thermal asymmetry and consequent discomfort risks

Victor Candas
CEPA du CNRS
Strasbourg Cedex, France

Introduction

The human being expresses thermal sensations because he has lots of thermo-sensors in the body, especially in the skin. These sensors give mainly local information about the thermal state of the periphery and the central integration of all the signals leads to expression of pleasantness or unpleasantness. Since many years, numerous studies have allowed to assess the skin temperature ranges under which thermal comfort is not compromised (Olesen *et al.* 1973). But the local skin temperatures vary depending upon the ambient parameters and even if the changes are small and not global, discomfort may occur. As long as the environment is more or less uniform (or homogeneous), the risk of discomfort is only dependent upon the amplitude of the climatic deviation towards cold or heat (Fanger 1970). To such cases, measures of ambient (air temperature, humidity and velocity, radiant temperature) and human (metabolic activity, clothing insulation) parameters allow to estimate the overall thermal balance and its possible deviation from optimal equilibrium.

But in cases of non uniform climates, comfort prediction is more complex. For instance, the concept of operative temperature which integrates in some way the convective and radiative heat flux fails to reflect the possible change in heat exchanges, when air and wall temperature are equal or almost equal. Yet, the human skin will loose more heat if the air (at a temperature generally lower than that of the skin) becomes more agitated. Taking this effect into account requires air velocity assessment by using anemometers: technical problems of measures may arise : direction, turbulence, very small levels of intensity. It appears therefore obvious that an integrative parameter has to be found, which could describe in a simple term the possible local skin temperature changes due to modifications in heat exchanges. Some devices do exist (as those built by Brüel and Kjør) but too many devices would be needed to assess all body parts ; in addition, no device will reproduce the human shape and the clothing effects. Only a well equipped manikin can do it.

Methodology and Results

The manikin either nude (0 clo) or clothed with the KSU standard ensemble (0,6 clo) is exposed seated (on a cane chair) in a climatic chamber facing the low air movement (0,15 m.s⁻¹). Front and rear walls are inlet and outlet of air, therefore

these wall temperatures are always equal to that of the air. Left and right walls, floor and ceiling can be regulated separately.

The manikin is temperature-controlled at 34°C over the 35 zones. Exposures last 80 minutes or more to ensure steady state. Mean values are obtained by averaging data over the last 20 minutes (or more).

Convection and radiation: effects on nude manikin

For this condition, the ambient parameters were:

- Homogeneous climate (HOMO): all values at 24 °C;
- Convective climate (CONV): 2 walls and ceiling at 19 °C, floor at 24 °C and air temperature at 25,6 °C;
- Radiant climate (RAD): 2 walls and ceiling at 34 °C, floor at 24 °C, and air temperature at 22,5 °C.

Results (Figure 1) clearly show that for the same global heat flux, the distribution of the local heat losses differed between conditions. The convective climate induced the largest difference between head and trunk while the radiant climate reduced considerably the head heat loss. Compared to a "normal" homogeneous climate, the various heat losses of body segments differed.

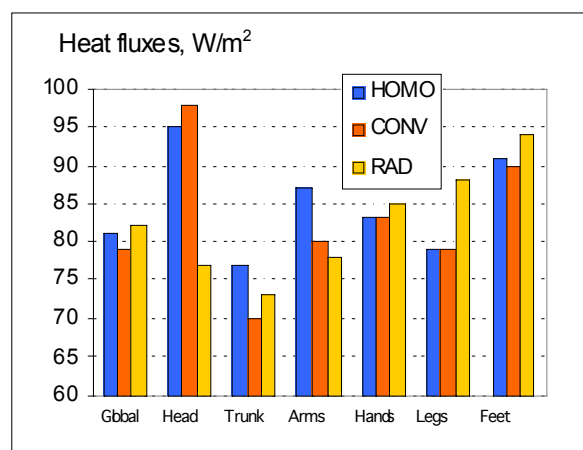

Figure 1.

Horizontal radiant asymmetry: effects on nude manikin

Here, we compared a climate with a warm ceiling (44 °C), a cold floor (14 °C), and air and wall temperatures at 24 °C to a homogenous climate (24 °C). For very similar global heat losses (80 Wm⁻²), the radiant asymmetry reversed the normal differences found in a uniform climate (Figure 2), the upper half part of the body losing less heat in opposition to the low part of the body. But at the same time, the difference in heat fluxes between front and back was also reversed. Such a non obvious result may explain human discomfort in some cases.

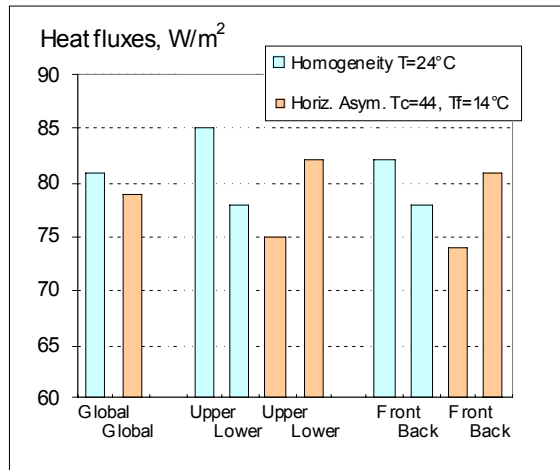

Figure 2.

One warm wall: effect on clothed manikin

In these experiments, all parameters were kept at 25 °C except the wall located on the left side of the manikin, which was seated at either 1 meter or 2 meters of this wall, the temperature of which was changed from 4 to 60 °C, by 7 °C steps.

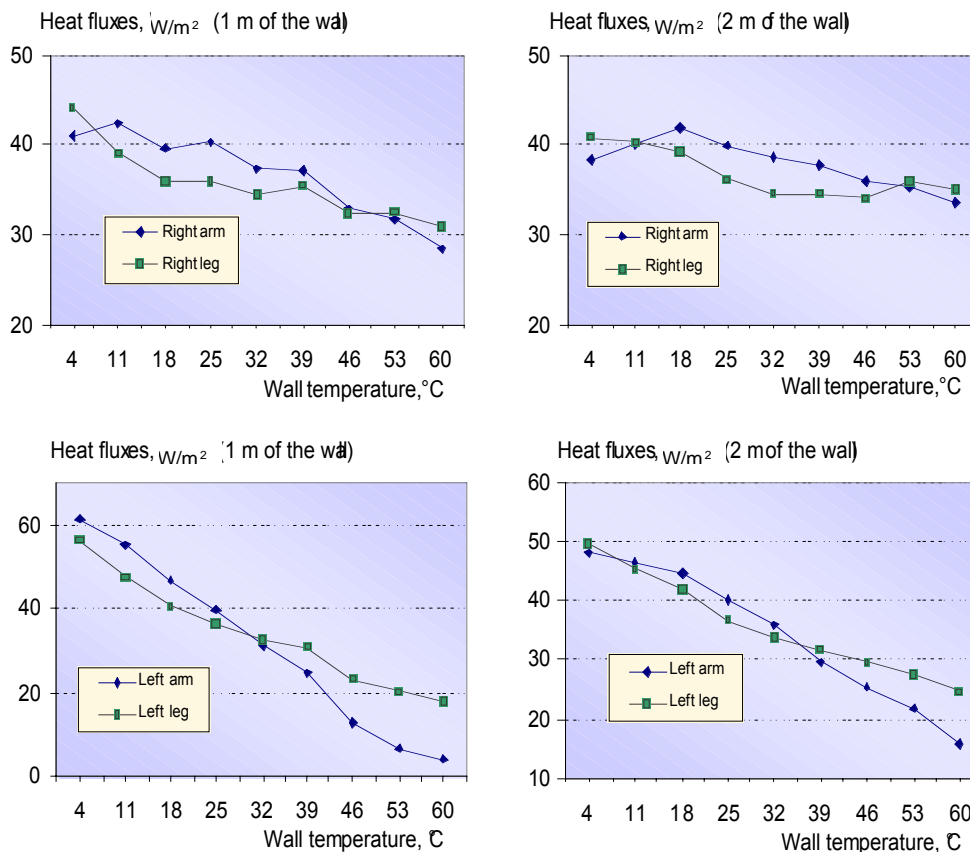

Figure 3.

The results showed (Figure 3) that of course the left side of the manikin was much more affected at 1 m than at 2 m, and more than the right side. An interesting

result is the heat loss from the arm was more reduced than that of the leg. This was verified in another experiment in which the difference between left and right walls (symmetrically to 25 °C) was increased from 0 °C to 6, 12 and 18 °C (Figure 4). The heat flux asymmetry was larger in arms than in legs. Such effects might have also important consequences on discomfort occurrence.

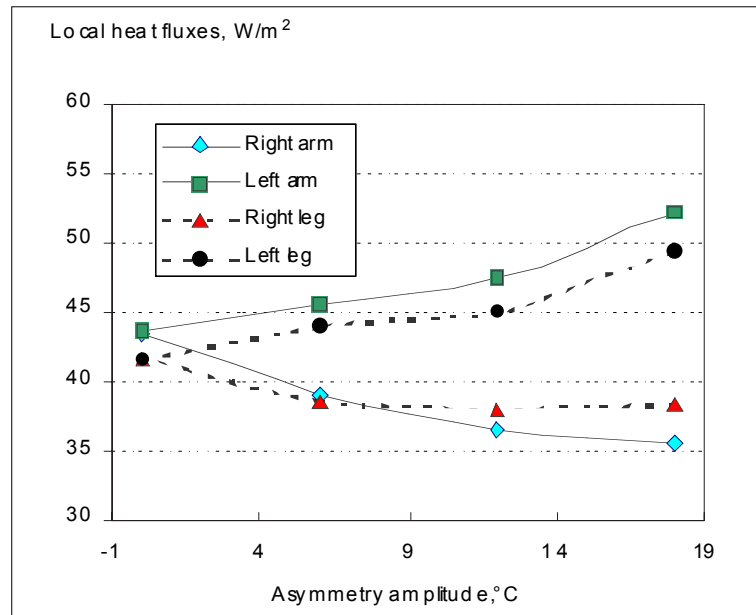

Figure 4.

Warm floor or warm walls: effect on clothed manikin

We tried here (Figure 5) to keep operative temperature as close as possible to 25 °C by warming either the floor at 34 °C (all other parameters being equal: 23,6 °C) or by warming left and right walls and ceiling, 43 °C, air and floor temperatures being kept at 19 °C.

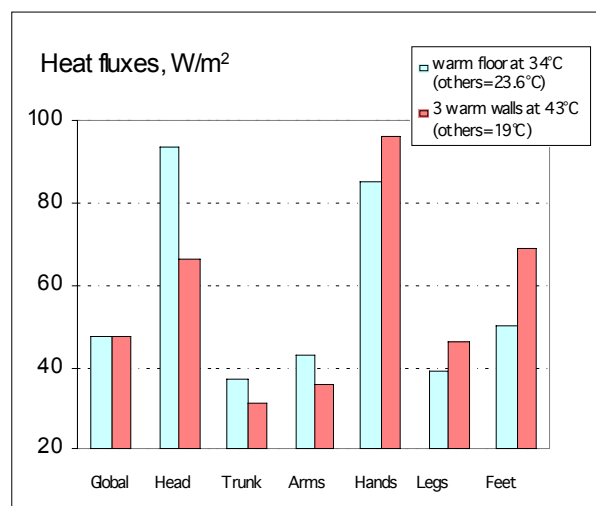

Figure 5.

The same global heat flux was obtained as wanted (47 W/m^2). Here obviously the climate effects were different on the extremities: inverted heat losses were found on head, hands and feet. Knowing the importance of the extremity thermal sensation in the genesis of discomfort points out the impact that could have such thermal changes in human.

Conclusions

It must be first recalled that the use of a thermal manikin is essential for the assessment of the clothing insulation. It is the only tool allowing a clear estimation of the heat fluxes of the various body parts of the clothed individuals.

But it is also absolutely necessary for assessing the environmental effects of non uniform climates. Even though it could be argued that local measures without a manikin can be done, carrying out all the required measurements would be time consuming, could be expensive, and even not accurate for three reasons:

- it does not reproduce the real situation, the human does interact with the environment,
- it does not make it possible to obtain all data at the same time,
- it cannot give a global result for the whole body.

Non uniformity of the climate implies that local heat losses will (or may) differ from those found in an homogeneous condition. The use of a thermal manikin will allow a good estimation of the local as well as the global heat losses as a consequence of the various thermal influences. In addition, due to the fact that it has the human shape, some specific effects will be more adequately assessed with a manikin than with any other device, namely the radiant influences and the convective influences of the air velocity.

An other field of investigation remains to be explored by using a manikin, it concerns the convective and radiative properties of garments and ensembles.

References

- Candas V, Bothorel B, Gartner M, Hinkel F. Globe operative temperature is not a good index for describing the effects of air and radiant temperatures on man.
In: *ICEE 94*, Montebello, Canada, September 25-30, 1994
- Fanger P.O.(1970), *Thermal comfort*, Danish Technical Press, Copenhagen, 1970.
Published by McGraw-Hill Book Company, 1973, New York.
- Olesen B.W., Fanger P.O.(1973). The skin temperature distribution for resting man in comfort. *Arch. Sci. Physiol.*, 1973, 27, A 385-A 393.

Assessment of the physiological wear comfort of garments via a thermal manikin

Volkmar T. Bartels and Karl-H. Umbach
Hohenstein Institutes,
Boennigheim, Germany

Introduction

Tests with thermal manikins are frequently used to determine the thermal insulation of clothing ensembles. However, in assessing the thermophysiological impact and wear comfort of garments, it is insufficient just to measure their insulation value. In contrary, it is necessary to find a predictive model, which translates the laboratory measurement data into the wear comfort experienced in practice, as it is shown in Figure 1. In fact, in assessing wear comfort, this second step is usually much more difficult to achieve than the measuring data, because the predictive model requires a broad experience, which can only be obtained by numerous trials with test persons, either in a climatic chamber or in the field.

In this article we present an empirical predictive model, which has been validated to assess the thermophysiological impact and wear comfort of garments by thousands of wearer trials. The clothing's main input parameters are its effective thermal insulation and water vapour resistance. It is also shown, how the water vapour resistance of a complete garment system can be obtained accurately by a combination of manikin and Skin Model tests, without needing a sweating manikin.

Methods

A scheme of the predictive model is given in Figure 2: Firstly, the model can predict the so called "range of utility" of a clothing system, i. e. the temperature and humidity range in between which the wearer does not feel either uncomfortably cold or warm. In this case, the required input parameters are personal characteristics of the wearer (like his body weight and surface area), the metabolic

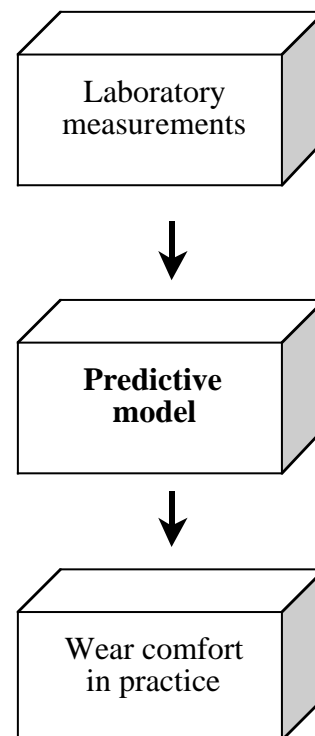

Figure 1. The necessity of a predictive model for assessing the wear comfort

rate, and the thermal insulation and water vapour resistance of the garment ensemble. Secondly, including the climatic conditions like temperature, humidity, and wind speed into the model, one can predict the overall wear comfort a wearer would perceive in practice.

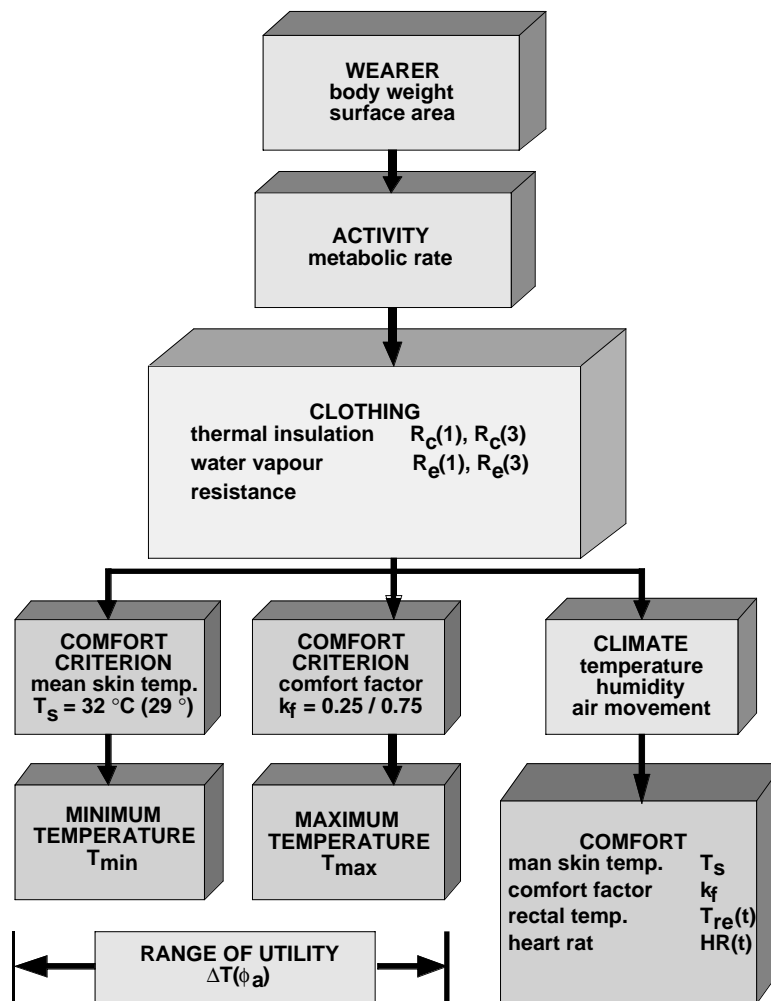

Figure 2. Scheme of the predictive model

As mentioned above, the predictive model requires the thermal insulation R_c and water vapour resistance R_e of the garment system. A thermal manikin is designed to determine R_c , but, in combination with Skin Model measurements according to ISO 11092 (ISO 11092, 1993), also the water vapour resistance can be obtained accurately by the following procedure: Firstly, the thermal insulation of the clothing system is determined by the thermal manikin, and the insulation of each textile used in the garment by the Skin Model. Combining both allows to calculate the amount of trapped and adhered air layers of the clothing system, which influence both, the thermal insulation as well as the water vapour resistance. With a given thermal insulation, also the water vapour resistance of air is known, therefore one can calculate the water vapour resistance of the trapped and adhered air of the clothing system. To obtain the water vapour resistance of the whole garment, one has to add the area weighted water vapour resistances of the textiles, which are determined by the Skin Model (ISO 11092, 1993).

Using this technique, the measurement of the thermal insulation and water vapour resistance of a garment system is very accurate. In this case the meaning of "accuracy" is, how good laboratory measurements correlate with results obtained by wearer trials with real test persons. In Figure 3 the data of wearer trials are compared to those measured by the thermal manikin "Charlie" (B Bilger, 1993) of the Hohenstein Institutes and the Skin Model. In the given example a typical 2-piece-suit has been investigated. The difference is 7.3 % in thermal insulation and 5.5 % in water vapour resistance. This has to be referred as a high accuracy.

The accuracy of 5–7 % obtained by a thermal manikin plus Skin Model is a direct challenge for the construction of a sweating manikin. To be favoured to a thermal manikin, its accuracy in comparison with real wearer trials has to be significantly better than these 5–7 %.

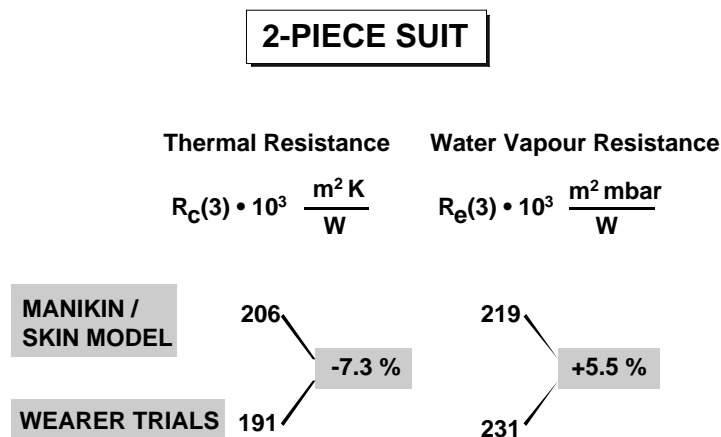

Figure 3. Via the thermal manikin "Charlie" and the Skin Model [1, 2] the effective thermal insulation as well as the water vapour resistance of a garment system can be measured accurately

However, even the most accurate measurement of thermal insulation and water vapour resistance is still insufficient for the assessment of wear comfort. As already mentioned above, it is necessary to translate these laboratory data into real comfort perception. For this a predictive model like that in Figure 2 is required, which is based on the results of wearer trials with real test persons, and whose accuracy is assessed also by a comparison with wearer trials.

As an example, in Figure 4 the prediction of the time pattern of the rectal temperature calculated by the model shown in Figure 2 is presented together with physiological data obtained by wearer trials in a climatic chamber. The wear situation corresponds to a significant heat load (ambient temperature 32.6 °C) and a "normal" clothing ensemble consisting of jeans and shirt. Obviously, prediction and physiological data coincide very well.

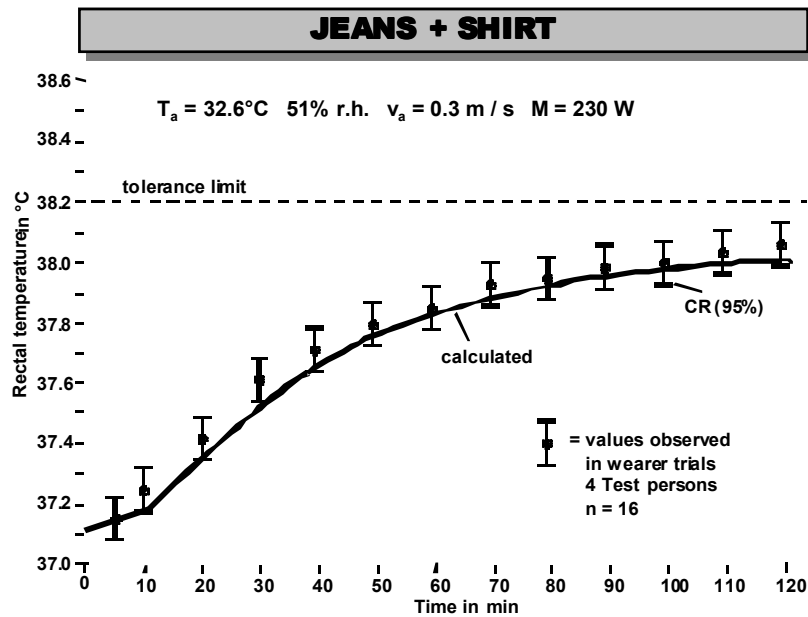

Figure 4. Prediction of the wearer's rectal temperature using the model of fig. 2, based on data measured with the thermal manikin and the Skin Model

The technique presented and using the thermal manikin, the Skin Model, and the predictive calculation is mainly used in the assessment of the thermophysiological impact and comfort of garment ensembles. However, it can also be applied to related topics, e. g. for determining the range of utility of sleeping bags, as it is specified in the German standard DIN 7943-2 [3].

Conclusion

We have shown, how a combination of a thermal manikin and the Skin Model can be used to determine the effective thermal insulation and the water vapour resistance of garment ensembles with an accuracy of approximately 7 % in comparison to wearer trials. It has also been shown that it is a prerequisite to translate these laboratory data into real wear comfort by a predictive model. The model presented here gives an accurate prediction of the physiological impact of clothing on the wearer, as well as of the wear comfort perceived in practical use of the garments.

References

- ISO 11092 (1993). *Measurement of thermal and water-vapour resistance under steady-state conditions (sweating guarded-hotplate test)*, 1993.
- B Bilger (1993). Charlie 4—a new thermoregulatory model of man for a more accurate physiological assessment of clothing. *Hohenstein Research Report*, May 1993 (in German).
- DIN 7943-2 (1995). *Sleeping bags—Part 2: Thermophysiological testing*, 1995.

Research of human non-evaporative heat diffusion pattern and mathematical model at low temperatures

Yang Tingxing
The Quartermaster Research Institute
Beijing, China

Introduction

The skin of human body is a heat exchange surface between human body and environment. The influences of environmental conditions, clothing insulation, human sense of cold and heat are first sensitively reflected in the change of skin temperature. Under comfortable conditions the energy generated by human body and the energy dissipated by clothing can reach a balance state with steady body temperature. At this time the skin temperature is about 33 °C. In 1941, Gagge.A.P established a formula to calculate the clothing insulation with unit clo according to this characteristic (Gagge.A.P Burton.A.C, 1994), which is:

$$I = \frac{\bar{T}_s - T_a}{0.75 \cdot M / A} \quad \text{Formula 1.}$$

In formula:

- I — clothing insulation (clo);
- \bar{T}_s — mean skin temperature under comfortable condition (°C);
- T_a — air temperature (°C);
- A — heat diffusion area (m²);
- M — diffused heat energy(W);
- 0.76 — non-evaporative heat diffusion coefficient.

According to the physical concept of this formula, a variety of thermal manikins have been developed in order to simulate the heat exchange process between human body and environment and use them to measure clothing insulation accurately.

However, people do not always live in an entirely comfortable condition. It is common to live in some uncomfortable conditions (Jia Siguang, 1987). As long as the condition does not go beyond a limit that the human body can stand, it has no influence to human health and exercise ability. Thus, it is of significance to guide clothes-wearing scientifically for us to study this kind of change pattern of human body skin temperature at low temperature.

Testing Methods

The subjects are healthy young men chosen at random. Each group is composed of 15 to 24 persons (the groups of more than 24 persons are merged ones for

repeated experiments). Testing environment (no wind, no heat radiator), lasting time (four hours), sitting posture, monitoring indexes (cold sense degree, the skin temperature of chest, arm, thigh and leg) can be planned according to testing conditions stipulated by GJB (National Military Standard) 58 - 85, the mean skin temperature can be calculated by weighted method. The testing clothing ensembles show at Table 1.

Table 1. Testing clothing ensembles and their insulation

No.	Ensembles	I(clo)
I	Unlined garment and trousers, fiber pile sweater and pants, long-sleeved shirt and pants	2.8
II	Overall, cotton-padded clothes and trousers (wadded amount 600g), long-sleeved shirt and pants	4.0
III	Overall, cotton-padded clothes and trousers (wadded amount 1000g), long-sleeved shirt and pants	4.6
IV	Overall, cotton-padded clothes and trousers (wadded amount 1000g), fiber pile sweater and pants, long-sleeved shirt and pants	4.9
V	Overall, cotton-padded clothes and trousers (wadded amount 1500g), fiber pile sweater and pants, long-sleeved shirt and pants	5.2
VI	Overall, fat cotton-padded clothes and trousers (wadded amount 1500g), cotton-padded clothes and trousers (wadded amount 600g), fiber pile sweater and pants, long-sleeved shirt and pants	6.0
VII	Overcoat, overall, cotton-padded clothes (wadded amount 550g), cotton-padded trousers(wadded amount 670g), fiber pile sweater and pants, long-sleeved shirt and pants	6.6

Note: The insulations (clothing + surface air layer) shown at Table 1 are measured by 78 - 1 thermal manikin developed by Quartermaster Research Institute.

Testing Results

The testing results show at Table 2 (17 groups).

Table 2. Experiment results

Group	I (clo)	Ta (°C)	Moment weighted mean skin temperature (°C)					'Uncold' ratio of entire process	Subjects
			Begin	At 1h	At 2h	At 3h	At 4h		
1	2.8	13.91	34.01	33.58	33.29	33.14	32.90	100.0	48
2	2.8	7.60	33.07	32.26	31.95	31.73	31.65	75.3	48
3	2.8	4.21	32.70	31.93	31.51	31.33	30.98	-	24
4	2.8	1.37	32.96	31.75	31.05	30.68	30.58	54.5	48
5	4.0	7.63	33.73	33.38	33.21	33.08	32.99	100.0	48
6	4.0	4.21	33.47	32.91	32.74	32.52	32.43	86.5	24
7	4.0	1.39	33.46	32.82	32.48	32.02	31.87	-	48
8	4.0	-3.93	33.15	32.13	31.84	31.67	31.55	78.6	24
9	4.6	-10.25	-	32.84	31.98	31.58	31.13	-	15
10	4.6	-15.20	34.78	32.68	31.84	31.29	30.92	59.0	18
11	4.6	-19.92	-	31.48	30.72	30.30	30.00	37.5	15
12	4.9	-15.25	-	32.79	32.02	31.57	31.23	-	33
13	4.9	-20.21	-	32.16	31.42	31.02	30.72	62.8	33
14	5.2	-20.19	-	32.48	31.93	31.48	31.22	-	33
15	5.2	-24.90	33.93	32.33	31.20	30.72	30.42	-	18
16	6.0	-24.90	34.53	32.11	32.03	31.59	31.11	-	18
17	6.6	-29.50	34.36	32.52	32.11	32.06	31.86	86.1	18

Discussion of skin temperature change

From Table 2, it is clear that in mass experiments the change process of moment mean skin temperature with time is a curve whose down slope decreases continuously. In order to reveal this process quantitatively, we once used a variety of models to describe this process, but the following model is the best one:

$$T_{st} = f(t) = T_{sk} + B e^{-t} \quad \text{Formula 2.}$$

In formula:

t — time(h);

T_{st} — moment mean skin temperature (°C);

T_{sk} — balanced skin temperature (°C);

B — change coefficient of skin temperature against time

By applying this model, we have conducted a correlation regress analysis on the experiment results one by one. The results show at Table 3. From Table 3, it is clear that the correlation coefficient between moment mean skin temperature T_{st} with time function (e^{-t}) is $0.99805 \geq r \geq 0.94990$.

Table 3. Change analysis of moment mean skin temperature (T_{sk}) against time (e^{-t})

Group	T_{sk}	B	r
1	33.07	1.0025	0.95331
2	31.69	1.4058	0.99486
3	31.19	1.5739	0.97027
4	30.65	2.3907	0.98837
5	33.05	0.7020	0.97791
6	32.50	0.9954	0.98343
7	32.05	1.4976	0.94990
8	31.57	1.5764	0.99805
9	31.24	4.4960	0.97742
10	31.12	3.7047	0.99150
11	30.05	4.0041	0.98533
12	31.30	4.1878	0.98102
13	30.77	3.8858	0.98497
14	31.29	3.3934	0.97010
15	30.63	3.4564	0.98158
16	31.41	3.2447	0.98108
17	31.80	2.4913	0.99247

After significant test, all the values are in the range of 0.05 and 90 % of them is in the range of 0.01. Obviously it reflects an inevitable trend, showing that within the scope of experiment the decline of moment mean skin temperature T_{sk} is a time function and the slope reduces continuously. While the slope approaches 0 in the end, the mean skin temperature approaches a fixed value i.e. T_{sk} .

Such a result provides reference for research on how to illustrate and predict quantitatively the adaptability of human body to cold environment. The modern physiology says that human body is of very strong temperature adjustment capability through sense, analysis, sifting and reflection of the central nerve system (Cao Junzhou, 1979). In cold temperature a series of physiological reaction of increasing heat production and decreasing heat diffusion may appear in human body, when clothing insulation is low and the dynamic heat balance of human body has been broken to some extent. For example, on the one hand heat production may be increased by muscle straining and shivering in cold. It may also be increased through endocrine system releasing some kinds of hormone such as thyroxine and adrenaline (except increasing exercise intentionally). On the other hand, when the blood vessel shrinks and the blood flow reduces, the surface skin temperature goes down in order to reduce the temperature difference between the skin and environment. In this way, the heat diffusion decreases. Heat production increases while heat diffusion decreases, so the broken dynamic heat balance is recovering gradually in low temperature if the coldness does not exceed the extreme (Human in cold environment, 1980). The distribution of skin temperature change in all parts of human body in low temperature may be used as a proof for such an inference. The experimental data at Table 4 are cited as examples.

Table 4. Change of skin temperature of a few parts with time

Group	Ta (°C)	I (clo)	Position	Experiment dates					Skin temperature in balance (°C)
				Moment skin temperature(°C)					
				Begin	At 1h	At 2h	At 3h	At 4h	
1	13.91	2.8	Weighted mean	34.01	33.58	33.29	33.14	32.90	33.07
			Chest	34.99	35.51	35.57	35.50	35.34	
			Arm	34.05	33.46	33.15	33.06	32.60	
			Thigh	32.90	32.05	31.54	31.27	30.95	
			Leg	33.58	32.36	31.80	31.63	31.17	
2	7.60	2.8	Weighted mean	33.07	32.26	31.95	31.73	31.65	31.69
			Chest	34.16	34.61	34.60	34.63	34.66	
			Arm	33.16	32.05	31.78	31.38	31.22	
			Thigh	31.81	30.38	29.75	29.31	29.27	
			Leg	32.57	30.96	30.55	30.00	30.16	
3	4.21	2.8	Weighted Mean	32.70	31.93	31.51	31.33	30.98	31.19
			Chest	33.98	34.21	34.27	34.49	34.46	
			Arm	32.70	31.76	31.00	30.58	29.98	
			Thigh	31.55	30.08	29.44	29.16	28.83	
			Leg	31.93	30.60	30.20	29.87	29.41	
4	1.37	2.8	Weighted Mean	32.96	31.75	31.05	30.68	30.58	30.65
			Chest	34.05	34.36	34.29	34.30	34.37	
			Arm	33.23	31.59	30.50	29.89	29.79	
			Thigh	31.44	29.48	28.54	28.08	27.87	
			Leg	32.42	30.33	29.50	29.06	28.80	

It is known from the data at Table 4 that the change of skin temperature on limbs (arms, thighs, legs) is more than that on torso (chest). This is the objective reflection of self-adapting process of human body to cold environment and the result of dynamic heat balance reestablishment of human body in low temperature. Certainly, such a balance is different from the balance in comfort. It is achieved at the cost of consuming more human internal energy and experiencing more discomfort in cold.

Heat balance analysis in cold condition

The recovered dynamic heat balance of human body in low temperature has made it possible for us to analyze human body heat balance.

Formula 1 can be rewritten as follows:

$$I = K \cdot \frac{\bar{T}_s - T_a}{H} = \frac{\bar{T}_s - T_a}{0.155 \cdot H} \quad \text{Formula 3.}$$

In Formula 3: H – non-evaporative heat flux (W/m²)
 0.155 — clo unit exchange coefficient

Because the clothing insulation is known in the experiment, Formula 4 can be inferred from Formula 3.

$$H = \frac{\bar{T}_s - T_a}{0.155 \cdot I} \quad \text{Formula 4.}$$

So the non-evaporative heat flux can be calculated with Formula 4. The results show at Table 5.

Table 5. Non-evaporative heat flux

Group	T _{sk} (°C)	T _a (°C)	I (clo)	H (W/m ²)	"uncold" rate(%)
1	33.07	13.91	2.8	44.15	100.0
2	31.69	7.60	2.8	55.51	75.3
3	31.19	40.21	2.8	62.17	-
4	30.65	1.37	2.8	67.47	54.5
5	33.05	7.63	4.0	41.00	100.0
6	32.50	4.21	4.0	45.63	86.5
7	32.05	1.39	4.0	49.45	-
8	31.57	-3.93	4.0	57.26	78.6
9	31.24	-10.25	4.6	58.19	-
10	31.12	-15.20	4.6	64.96	59.0
11	30.05	-19.92	4.6	70.08	37.5
12	31.30	-15.25	4.9	61.29	-
13	30.77	-20.21	4.9	67.12	62.8
14	31.29	-20.10	5.2	63.87	-
15	30.63	-24.90	5.2	68.90	-
16	31.41	-24.90	6.0	60.55	-
17	31.80	-29.50	6.6	59.92	86.1

It is known from Table 5 that the relation between T_{sk} and H is negative, i.e. the higher the mean skin temperature, the lower the heat flux. After correlation analysis for the data at Table 5, the result is:

$$r = -0.96480 > r_{0.01} (n=17)$$

It shows that the lower the steady weighted mean skin temperature, the lower the 'uncold' ratio¹. It has been proved that the reestablishment of human body's dynamic heat balance is at the cost of human body experiencing cold discomfort. The stronger the reflection, the deeper the discomfort degree.

¹ The ratio between the number persons of feeling uncold and the all subjects in experiment, checked every half an hour, 'uncold' degree is divided into comfort, a little cool and cool.

Conclusions

In this paper, the skin temperature change pattern of human body in low temperature has been explored by studying and analyzing the non-evaporative heat diffusion of human body and reestablishment process of heat balance according to the testing results of clothing insulation (17 groups, total 513 person-times). The conclusions are as follows:

1. In low temperature, when clothing insulation meets the comfortable need of human body, the continuous declining process of mean skin temperature against time can be described by a time function, its slope continues decreasing and finally achieve a steady value. It reflects the self-adaptable process of reestablishing dynamic heat balance in low temperature. Its function equation is $T_{st} = T_{sk} + B e^{-t}$.

2. The H value in balance state is related to T_{sk} after reestablishment of human body's dynamic heat balance in low temperature. When T_{sk} is in the range of 33 °C to 30 °C, H value can be evaluated by the formula: $H = 387.4 - 10.4 T_{sk}$.

References

- Cao Junzhou (1979) Survey of thermal manikin research abroad *Research on Quartermaster Equipment* 1979, vol 2, p1-10
Gagge.A.P Burton.A.C (1994). *Science* 1994, p428
Human in cold environment (1980) Translated by Ling Tiande *Research on Quartermaster Equipment* 1980, vol 4, p13-15
Jia Siguang (1987). Physiological effect of compound environment factor on flight and its application on engineering design. 1987.

Factors affecting the equivalent temperature measured with thermal manikins

Mats Bohm ¹, Olle Norén ¹, Ingvar Holmér ², Håkan O. Nilsson ²

¹ Swedish Institute of Agricultural Engineering, Uppsala, Sweden

² National Institute for Working Life, Solna, Sweden

Introduction

The results presented in this paper are derived from work package 3 of the EU-project EQUIV (SMT4-CT95-2017). The objective in this work package was to compare methods to measure equivalent temperature under realistic conditions in vehicle cabs. For this purpose different types of instruments were used. In this paper the results from manikins are presented.

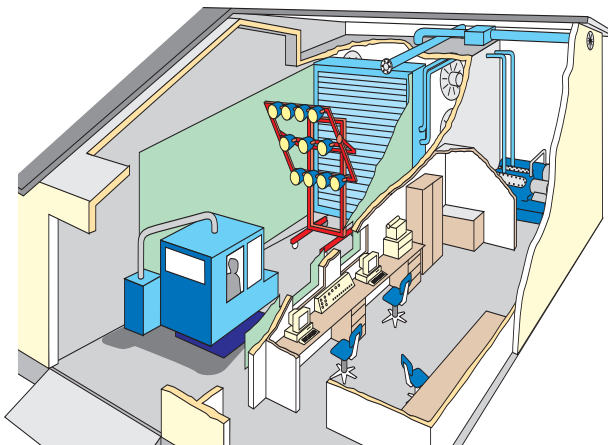

Figure 1. The experimental cab in the climatic chamber with the sun simulating lamps. The cab has its own temperature controlled HVAC. Most of the adjustment can be made without opening the door. The cab is designed so that it is easy to change material in walls to glass, type of glazing, position and design of air-inlets etc.

Experiments were carried out in an experimental cab in a climatic chamber during summer as well as winter conditions. Simulated sun load was used in summer conditions.

The purpose of part of the project was to compare the equivalent temperature (t_{eq}) determined with the different methods in more realistic and complex thermal situations than in a climatic chamber designed for human subjects, but still in a controlled environment.

This part of the project was carried out by Swedish Institute of Agricultural Engineering and the Swedish National Institute for Working Life.

The thermal manikins

A man-sized and shaped sensor with the surface covered with numerous individually controlled zones makes a useful instrument for measurement of whole body as well as local heat fluxes. The independent zones of the manikin are heated to a controlled and measured temperature. Low-voltage power is pulsed to each zone

at a rate that allows the maintenance of a chosen constant or variable surface temperature. It is also possible to maintain a constant power supply to the surface. The power consumption under steady-state conditions is then a measure of the convective, radiative and conductive heat losses (dry heat loss). Measurements and regulation are taken care of by a computer system. Typically, the quantity measured for each zone is the power consumption or heat loss, Q (in W/m^2), and the surface temperature, t_{sk} (in $^{\circ}C$). The direct measurement of Q and t_{sk} eliminates the need for determining the other components. By normation to a climate according the definition of equivalent temperature is this heat loss converted to equivalent temperature, preferably presented in a comfort diagram. The tests were performed with three thermal manikins named AIMAN, HEATMAN and NILLE, Figure 2. The technical data about the manikins are presented in Table 1.

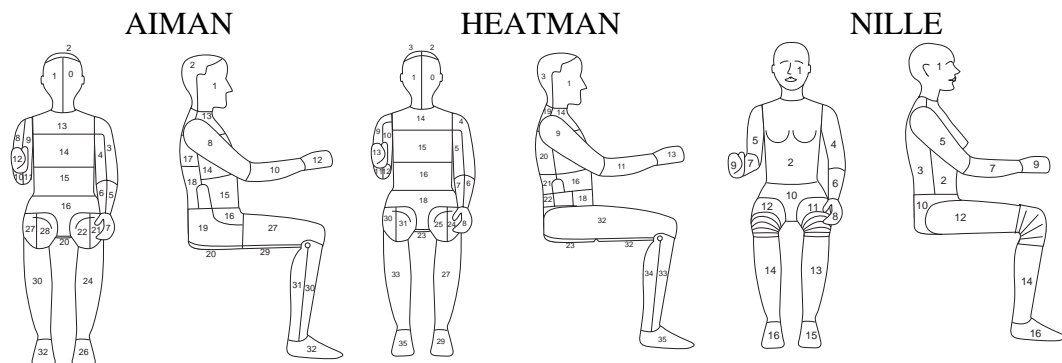

Figure 2. This figure shows schematic pictures of the three heated manikins AIMAN, HEATMAN and NILLE. The figure also shows the division into different zones on the manikin. The result is not presented for all of these zones, but only for 16 zones that will be shown later in this report.

Table 1. Technical data about the thermal manikins Aiman, Heatman and Nille

Manikin	AIMAN	HEATMAN	NILLE
Size	C50	Eur 42 – 44	
Length	Sitting	173 cm	166 cm
Weight	16 kg	16 kg	31 kg
Number of zones	33 + 3 t_a	35 + 1	16
Regulation principle possible () not used in <i>EQUIV</i>	Const. t_{sk} (Const. Q) (Comf.eq.)	Const. t_{sk} (Const. Q) (Comf.eq.)	Comf.eq. Const. t_{sk} (Const. Q)
Clothing () not used in <i>EQUIV</i>	Dressed 0.6 Clo Undressed	Undressed (Dressed)	Nude Dressed 0.51 Clo

Equivalent temperature – t_{eq}

To make the measurement values clear and easy to understand, they are converted from heat-loss into the normalised unit equivalent temperature, t_{eq} , which is calculated from the heat loss. t_{eq} is defined as the temperature in a room where the

temperature of the air and the surrounding walls are the same and the air is standing still (i.e. a homogeneous climate), in which the dry heat-loss from a person is the same as in the actual cab climate (Figure 3). Somewhat simplified t_{eq} can be described as the temperature in a normal room that gives the same thermal sensation as the actual cab climate. It is important to notice that t_{eq} is not a temperature that can be measured by a thermometer and that t_{eq} cannot be translated to an air temperature in a complex climate.

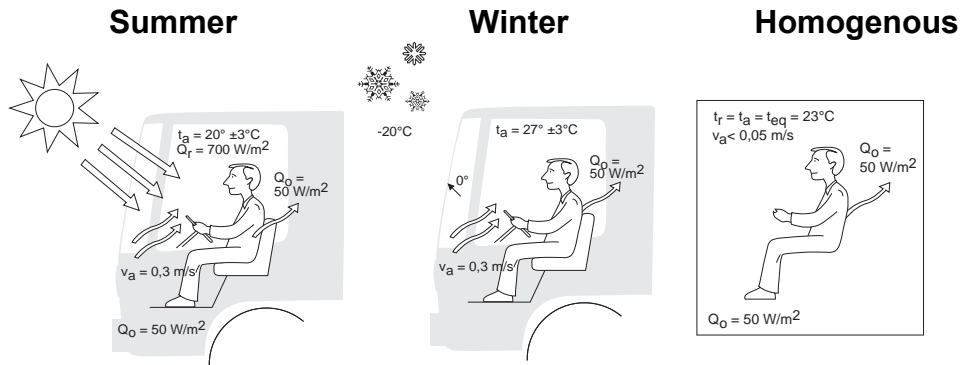

Figure 3. Equivalent temperature, t_{eq} , is the temperature in a room with homogenous climate in which the driver has the same dry heat loss as in the actual climate. The relation between heat loss and t_{eq} is established with a calibration in homogenous climate where the heat transfer coefficient is established. The equivalent temperature for zone n for actual cab climate can then be calculated as: $t_{eq,n} = t_{sk,n} - Q_n / h_{hom,n}$ where $t_{sk,n}$ = surface temperature on zone n , Q_n = heat loss from zone n , and $h_{hom,n}$ = the heat transfer coefficient for zone n .

Results

The results show significant differences between equivalent temperatures determined with the different manikins. However, the differences can be explained with principal and physical differences between the manikins used.

Although the methods could not determine equal t_{eq} in the same thermal situation, they are still useful to measure the thermal environment. They all integrate the important thermal factors, e.g. they could all measure thermal effects of radiant load or detect draft. However, to be able to compare results they must be measured with the same type of manikin.

In the following sections the factors that influence the determination of t_{eq} will be presented as well as why and how they have an impact on the results. What differences can be seen in the results and which factors are causing them?

Size and posture

The size and posture of a manikin will have an impact of the measured t_{eq} . The thermal conditions in vehicle cabs are often inhomogeneous. The ambient air temperature, as well as the radiant temperature can vary several °C between locations only a few centimetres apart. In addition, strong air jets from the nozzles creates an inhomogeneous air velocity field. Therefore differences in location for corresponding zones may give significant differences. In worst case, a change of

position with only few cm:s may cause the zone to be affected by an air jet from a nozzle with up to 2 m/s air velocity and a temperature that is 10 - 15°C lower in summer, or 25 - 35°C higher in winter than the cab temperature. The effects of size and posture can be seen in the results from most of the experiments, but it is more obvious in conditions with high fan speed.

In a small compartment like a vehicle cab there will also be another effect of size. The volume of a human sized body will have an impact on the cab climate itself. The air streams will be forced in other directions with a person in the seat compared to an empty seat. Hence, a manikin and a small sensor will in fact measure in different thermal conditions in identical cabs under identical conditions, and the results will of course be different. The manikins, like a real human being, will also add heat to the cab, which creates convection around the body. However, it is reasonable to believe that the added heat will have a minor impact on the result compared to the effect of the volume of the body. The effect of the size of the body can also be seen in the results. With exactly the same settings in the cab and the climatic chamber it has not been possible to recreate the same temperature and air velocity fields around the driver's position with manikins as with smaller sensors.

Number of sensors/zones

The number of zones of a manikin has an impact on the results in two ways. The first also applies to other types of sensors than manikins. The resolution of an instrument will of course be better the more zones or sensors it has. However, It is not practical to present results from too many zones. However, if there are too few zones the resolution may not be adequate.

What is the best number of zones will be decided by the situation. When assessing the thermal comfort of a cab, the number of zones must be sufficient. Figure 4 shows t_{eq} -values measured in a sunny summer condition with the same manikins but calculated for 16 and 6 zones respectively. As can be seen it is not possible to detect the full impact of the radiant heat load with 6 zones.

Impact of division or size of zones

The other, and maybe more important, way that the number of zones will have an impact on the results on manikins is more related to the way the zones are divided from each other. A low number of zones imply that each zone must be larger than if there are many zones. With large zones there is an apparent risk that there will be great differences in thermal conditions over the surface within the zone due to draft, local sun load or different insulation etc. This will lead to errors in the calculation of t_{eq} . Below it is explained why.

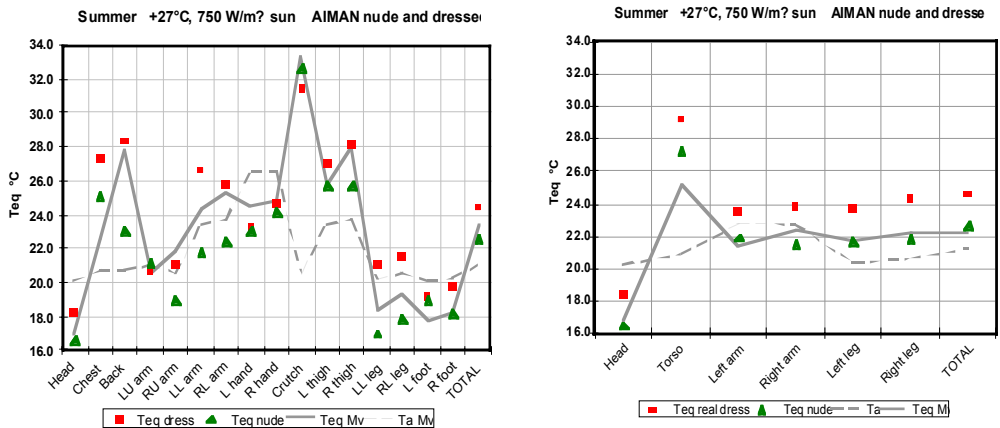

Figure 4. The graphs at the left show results from the same measurement with AIMAAN, but calculated for 16 and 6 zones respectively. As can be seen, the result loses all resolution when it is calculated for too few zones. It is difficult to see any impact of the sun load with 6 zones, while it is easy to see which zones are affected by the sun load with 16 zones.

It is important that the zones of a manikin are divided in such a way that the thermal conditions are similar within each separate zone, otherwise the t_{eq} will be overestimated. This can be shown by simple calculations.

Imagine for example the body part "thigh". The rear side is in contact with a seat that adds heavy insulation (heat transfer coefficient, H_i , assumed to $0.53 \text{ W/m}^2, \text{ K}$), and the front side is exposed to ambient air (heat transfer coefficient, H_z , assumed to $8 \text{ W/m}^2, \text{ K}$). Now imagine two manikins. The first, **manikin A**, with two zones, one on the front side completely exposed to the ambient air (**zone 1**) and the other on the rear side completely in contact with the seat (**zone 2**). The second, **manikin B**, with only one zone (**zone 3**), of which 50% is in contact with the seat and 50% is exposed to the ambient air.

The characteristics of the heat exchanging surfaces are such that the heat loss ideally is uniform within a zone (because the resistance wire gives the same heating power per length). However, the temperature will vary over the surface if the thermal condition varies. The average temperature over the surface is kept at a constant level of 34°C but there are often local divergences.

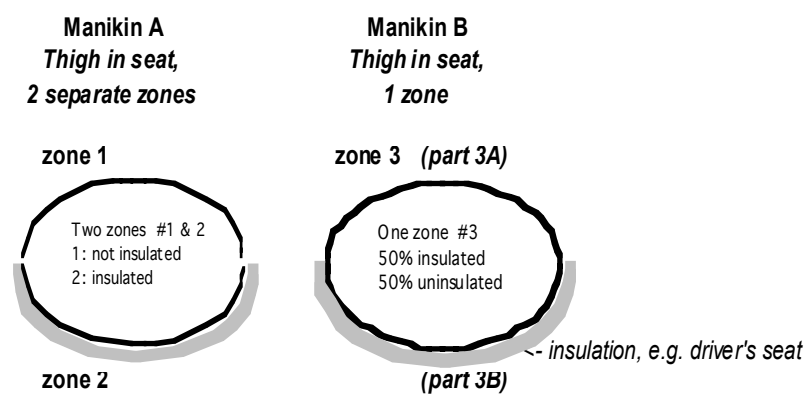

Figure 5. The figure shows imaginary sections of thigh zones of two different thermal manikins. On the first manikin the thigh consists of two zones, one completely in contact with the seat and the other completely exposed to ambient air.

The equivalent temperatures “measured” with the different manikins are calculated:

$$t_{eq.,M,n} = t_{sk,n} - Q_n / H_{tot,n}$$

Table 1 shows the results calculated for the different types of manikins. The measured t_{eq} for the whole thigh will be 28.7 °C for manikin A and 32.8 °C for manikin B. Manikin B overestimates the t_{eq} with 4.1°C! Because of the evenly distributed heating (= heat-loss), the real temperatures will be higher than the regulated 34°C on the surface that is exposed to the warmest thermal condition, regardless if it is caused by insulation, as in this case, radiant heat load or high air temperature. Therefore the part of the zone with the colder thermal conditions will have a lower surface temperature. This implies that the heat loss from the zone will be lower than it would be if the surface temperature were the intended (and measured) 34°C. Because the real surface temperatures of the parts are unknown and the mean value of the whole zone is used in the calculation, the calculated t_{eq} will always be overestimated on a zone with different thermal conditions over the surface!

Table 2. A theoretical calculation of surface temperatures, heat-fluxes and equivalent temperatures for two similar segments of a manikin. One segment consists of two zones, one entirely in contact with insulation and the other entirely exposed to air. The other consists of only one zone of which 50% is exposed to air and 50% is in contact with the insulation. The fictive segment can e.g. be a thigh of a manikin that is sitting in a driver’s seat.

Zone	Manikin A			Manikin B			
	1 front	2 rear	Mv	3A front	3B rear	3	
<i>Environment (=condition) used for calculation</i>							
$t_{eq,r}$	24	24	24	24	24	24	°C
H _z	8	8	---	8	8	8	W/m ² ,K
H _i	---	0.53	---	---	0.53	0.53	W/m ² ,K
H _{tot}	8	0.50	4.25	8	0.50	---	W/m ² ,K
<i>Surface temperature calculated for manikin</i>							
t_{sk} measured	34	34	34	---	---	34	°C
$t_{sk,r}$ "real"	34	34	34	25.2	42.8	34	°C
<i>Calculated Heat-loss</i>							
Q	80	5	42.5	9.4	9.4	9.4	W/m ²
<i>Calculated t_{eq}</i>							
$t_{eq,M}$	24	33.4	28.7	---	---	32.8	°C

The error becomes even worse if we want to assess only the thermal comfort of the part exposed to air in the cab regardless of the seat. With manikin A it is possible to get a value for the part of the thigh exposed only to the ambient air. With manikin B it is only possible to get a value for the total zone, which is already too high. The difference between manikin A and B in this case is 8.8°C! The impact of division of zones can be seen in all of the experiments. It is especially obvious when the manikin’s thighs are compared in conditions without

sun load. Sun load makes the front side warmer, which reduces the asymmetry between the rear and the front side. The manikin NILLE, on which the thighs consist of only one zone, always measure higher t_{eq} than AIMAN, on which the thigh consists of three zones.

Impact of different regulation principle

There are basically three different principles of regulation of surface temperature and heat loss from the heated sensors tested in the project, namely;

- 1 - Constant surface temperature (with resultant heat loss).
- 2 - Constant heat flux (with resultant surface temperature).
- 3 - Comfort equation (surface temperature is dependant on the heat flux).

Constant surface temperature is either used with the same temperature on all zones, or with different, but constant, temperature for different zones, e.g. reduced temperature on limbs.

The main advantage with the constant surface temperature principle is that the response time is short. Because the surface temperature, and therewith the "body" temperature is constant, there is no change in heat stored in the manikin. If the same temperature is chosen on all zones there will be no internal heat flow between neighbouring zones.

The main disadvantage is that it is more or less unstable because of the regulation. The range in which the principle works is also limited. If the t_{eq} is higher than 34°C it will have no heat loss and therefore become a passive sensor showing the operative temperature. The surface temperature is normally similar to that of a human being. In these experiments 34°C has been used on all zones on the AIMAN and HEATMAN manikins.

Constant heat flux can, like constant surface temperature, be used with the same value on all zones or chosen individually for the zones. A constant heating power is supplied to the surface and the resultant surface temperature is measured.

The advantages with this method are the "unlimited" measuring range, the stability (no regulation) and that it can measure a transient without disturbance of a regulating system.

The disadvantages are that the surface temperatures can be unrealistic and that it is slow in comparison with a regulated system. There may also occur internal heat flow if zones have different temperature. A constant heat flux of 85 W/m² is used by artificial surface in these experiments, while the surface temperature varies several °C between different conditions.

The surface temperature of a manikin or sensor controlled with the **comfort equation** will vary with the heat loss in the same way as on a human being. Depending on the theoretical insulation of the instruments, the equation may be different. In the experiments with NILLE two equations were tested:

- 1: $t_{sk} = 36.4 - 0.0540 \cdot Q$ corresponding to a nude surface, and
- 2: $t_{sk} = 36.4 - 0.2245 \cdot Q$ corresponding to a clothed surface (1 Clo).

The *advantages* of this principle are that the surfaces will have realistic temperatures compared to human surface and that the range of use is wider than with constant surface temperature. The experiments showed that the impact of clothed versus nude manikin is much lower, and that the heat transfer coefficient is constant in the interval 19°C to 29°C. The principle also makes it possible to simulate clothing.

The *main disadvantage* is that it is slow compared to constant surface temperature. Another disadvantage is that, because of the fact that the surface temperatures varies in time as well as between zones, there will be internal heat flow. The temperature difference between neighbouring zones may be several °C, e.g. because of seat contact.

A manikin, or a sensor, will have different surface temperatures in the same thermal conditions depending on the principle used. Below it will be shown that it does in fact have an impact on the results. To see if different regulating principles etc. result in deviations of measured t_{eq} theoretical calculations has been made.

To begin with, the heat transfer coefficient for homogenous climate was calculated in a "theoretical calibration" in a 24 °C homogenous environment. For the comparison in Figure 6 the constant heat flux, 100 W/m², was chosen so that the surface temperature was 34 °C during the calibration, the same as for constant temperature.

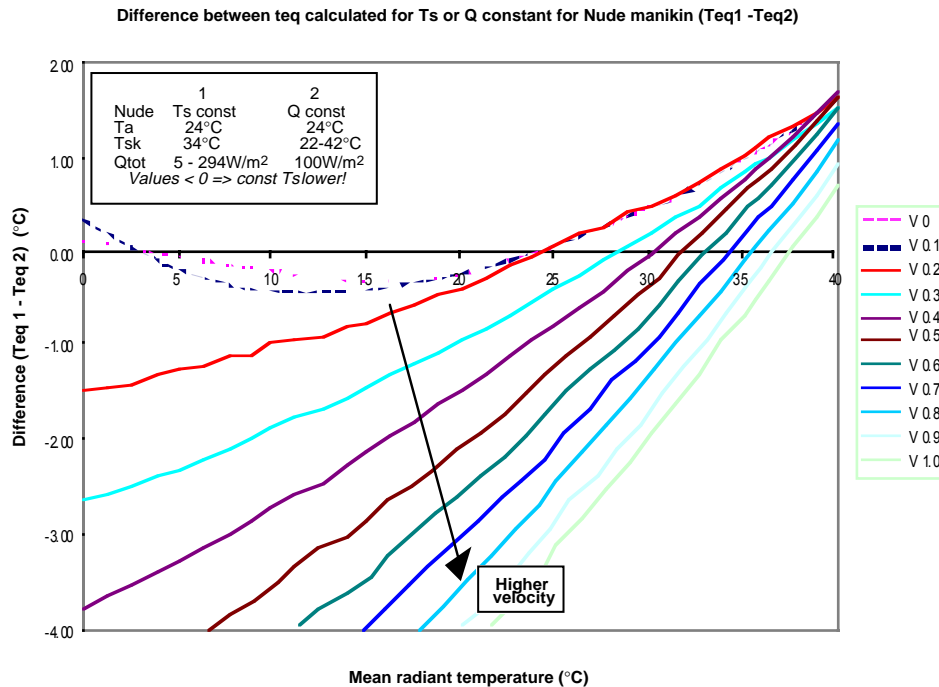

Figure 6. This figure shows the difference between t_{eq} calculated for a nude manikin with constant surface temperature of 34 °C, and t_{eq} calculated for a nude manikin with constant heat flux of 100 W/m². Negative values imply that t_{eq} for constant heat flux is higher.

When the "calibration" is done, the difference between t_{eq} for the different methods can be calculated for different climates, using the same equations as above and $t_{eq} = t_{sk} - Q / H_{cal}$.

Figure 6 shows that a manikin with constant surface temperature will measure higher t_{eq} compared to a manikin with constant heat flux when the radiant temperature is high and the air velocity is low. These are conditions in which the manikin with constant heat flux will have higher surface temperature than the one with constant temperature. Hence, a surface with higher temperature is more sensitive to forced convection (draft) and therefore measures lower t_{eq} compared to a surface with lower temperature. A surface with higher temperature is also less sensitive to radiant temperatures higher than the air temperature (e.g. sun load) and measure lower t_{eq} than a surface with lower temperature. The difference between t_{eq} measured with a sensor with constant surface temperature and a sensor with constant heat flux can be seen in the results.

Impact of clothed versus nude surfaces

The fact that different temperature on the heat exchanging surface has an impact on the measured t_{eq} will also be showed in the following section where nude and dressed manikins are compared.

Which method that gives the correct t_{eq} can be discussed, but the definition of t_{eq} states a human being with the same metabolism and clothing as in the real climate. Therefore a surface temperature similar to that of the heat-exchanging surface of a human being, normally the clothing surface, should give the best value. From that aspect the constant surface temperature mode should give better t_{eq} than the constant heat flux mode, and the comfort equation mode should give the best t_{eq} .

Manikins can be used nude or dressed. There are several advantages and disadvantages with both. A dressed manikin is closer to reality, but it has lower resolution and is more difficult to move without changing the clothing insulation and therewith the calibration. A nude manikin is more sensitive, at least to draft, and is easier to calibrate. However, the temperature of the heat-exchanging surface will be different from that of an insulated surface, and it will therefore measure different t_{eq} . In the same way as the control mode has an impact on the surface temperature on the sensors and therewith the measured t_{eq} , also clothing has an impact. With clothing on the sensor (or human) the surface exchanging heat with the "room" is not the skin, it is the surface of the clothing. The surface of the clothing has a temperature that is dependent on the heat flow and the temperature of the sensor. The difference between sensor surface temperature and clothing surface temperature will increase with the heat flow. Figure 7 the results of theoretical calculations, made in the same way as above, comparing t_{eq} determined with a dressed and a nude surface are presented.

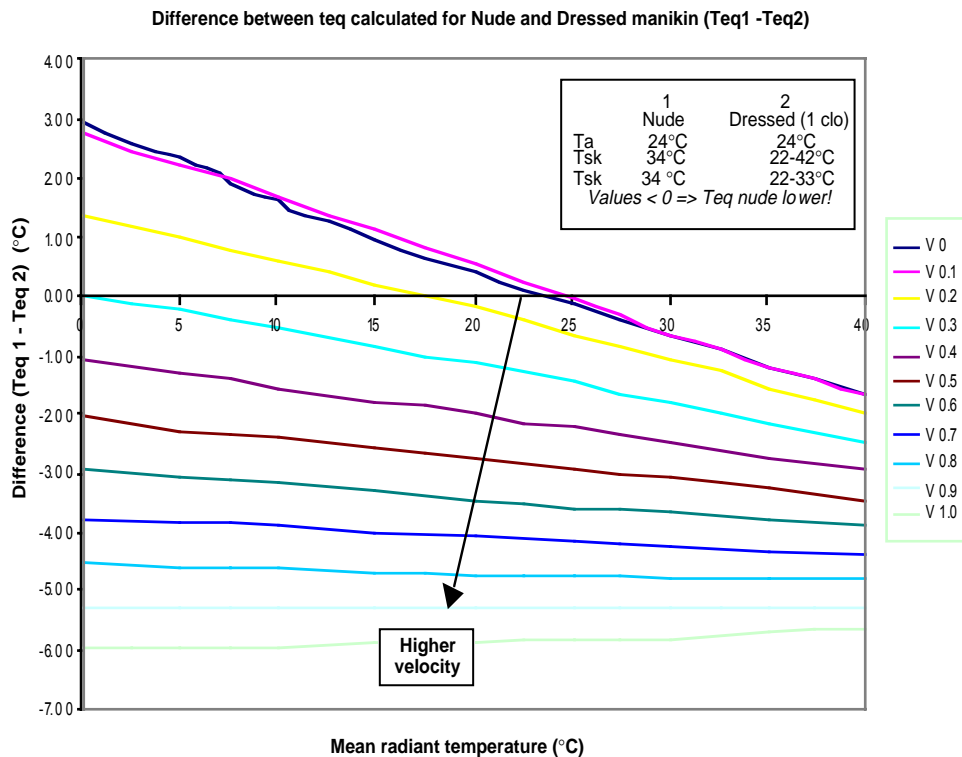

Figure 7. This figure shows the difference between t_{eq} calculated for a nude manikin and t_{eq} calculated for a dressed manikin, both with constant surface temperature of 34°C. Negative values implies that t_{eq} for a dressed manikin is higher. Also in this case a lower temperature of the heat-exchanging surface will lead to higher measured t_{eq} .

The results show that the differences between t_{eq} measured with a nude and dressed manikin will increase when the thermal asymmetries increase. The nude manikin is more sensitive to draft, because of higher temperature on the heat-exchanging surface, and will measure lower t_{eq} when the air velocities increase. The nude manikin is less sensitive to divergent radiant temperatures, e.g. low from glazing in winter climate or high from sun load.

This can also be seen in the results on several occasions, especially in the sunny summer conditions where the nude manikins show considerably lower t_{eq} , see Figure 8. To get further proof that the clothing will affect the results, calibrations and experiments were carried out with NILLE and AIMAN both with and without clothing. The results from these comparisons confirm what is said above. Figure 8 shows the result for AIMAN in sunny summer condition, both with and without clothing.

On the basis of the results from this project it is only possible to conclude that clothing will affect the result. But the definition of t_{eq} states, as said above, that it applies for a human being with the same metabolism and clothing. Therefore it is reasonable to believe that a dressed manikin will give more accurate results.

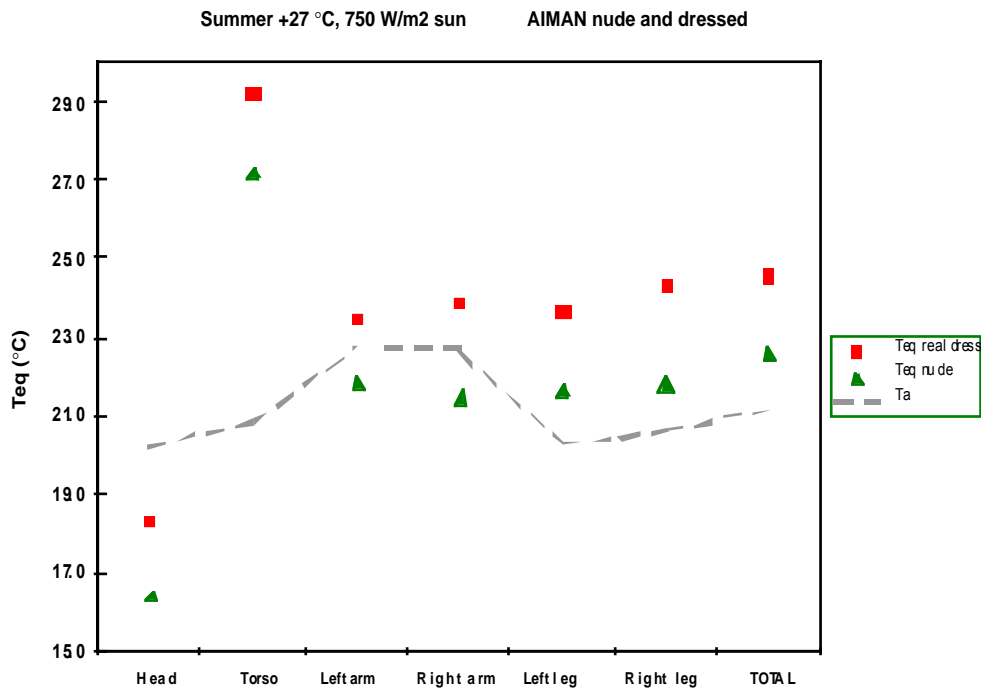

Figure 8. This Figure shows the results from measurements in the same thermal conditions, "sunny summer", with AIMAN dressed and with AIMAN nude. Calibrations were made before with nude as well as dressed manikin. The results clearly show the difference between t_{eq} measured with a nude and a dressed manikin. T_a is the ambient air temperature.

Conclusions

There are significant differences between the t_{eq} measured with the different manikins. The differences can be explained and the factors that are causing them can be controlled or regulated.

It is possible to use thermal manikins to evaluate climate. Relative comparisons of results measured with the same manikin can be done with the present configuration, whereas the manikins need to meet certain specifications to be used in absolute measurements. One major source of the differences between manikins is different temperature of the surface exchanging heat with the surrounding room. These differences can be caused by different insulation, regulation mode and dividing of zones. Other sources of deviations are size and posture. A vehicle cab is a small space with asymmetric climate. Thus size and posture will influence in two ways:

- 1 - a body will have an impact on the climate itself, and
- 2 - a small change in position may put sensor in other climatic conditions.

The number of zones may have great impact on the results. Of course a high number of zones gives better resolution. Another aspect is that large zones exposed to different thermal conditions may have deviations in temperature over the surface. This will cause the t_{eq} to be overestimated. It is reasonable to believe

that the best t_{eq} , according to the definition, will be obtained with a sensor that is influenced by the climate in the same way as a human being. This sensor would have to be of the same size and shape as a human being, with realistic clothing and with realistic surface temperatures for the normal activity level in the cab.

With the constant temperature principle the range of thermal conditions in which the instrument can be used will be limited. If the climate becomes warmer than the surface temperature, normally 34°C, the heat flux will be 0 W/m² or the surface may even gain heat. It will thus be out of range concerning t_{eq} measurements, because the definition states “in which a person will exchange the same dry heat loss”, which no instrument can do. However, it will still measure the thermal conditions as a passive sensor since the surface temperature is measured.

Also the comfort equation principle has problems with the range of use for the same reasons as constant surface temperature. But with the comfort equation the range of use is larger because the surface will be heated up to 36.4 °C.

With constant heat flux the only limitation of the range of use is the risk of overheating. On the other hand, the surface temperatures may be unrealistic compared to that of a human being, and the method will not measure the correct t_{eq} according to the definition. To be able to compare results from different measurements, e.g. to compare climate in two cabs, they must be carried out with the same type of manikin and methodology. Standardisation of the manikins and methodologies are necessary.

Further research is needed regarding the methods abilities to predict human thermal sensation, although there are indications that this is possible.

Acknowledgement

The EQUIV project was funded by the European Commission. Work package 3 was also funded by the Swedish Council for Work Life Research and the Swedish National Board for Industrial and Technical Development (NUTEK).

Literature

- Bohm, M, Holmér, I, Nilsson, H, Norén, O. *Use of a thermal manikin to improve the cab climate*. Report N. 94-D-041, Int. conf. on AgEng. Milano, 1994.
- Cisternino M. EVA manikin - *Operating Instruction Manual-Rev.2.0*. Fiat Reserach Centre Internal Document-June 1996.
- Holmér, I.; Nilsson, Bohm, M.; H.; Norén, O. *Evaluation of thermal environment in automotive vehicles*. 2:nd International Conference on Vehicle Comfort. Bologna, 1992.
- ISO/WD 13731, *Ergonomics of the thermal environment – Definitions, symbols and units*. ISO/TC 159/SC 5/WG 1. 1995.
- Madsen T.L., Olesen B., Reid K. New methods for evaluation of the thermal environment in automotive vehicles. *ASHRAE Transactions* 1986.
- Madsen T.L., Popiolek Z., Wiechula I. *A local discomfort meter*. 2:nd world congress on heating, ventilating refrigeration and air conditioning – Clima 2000. Sarajevo, 1989.

- Madsen T.L., Soehrich E., Popiolek Z. *Measurement of draught sensation by a new skin element*. Room vent '90. Oslo, 1990.
- Matsanuga K., Sudo F., Tanabe S., Madsen T.L. *Evaluation and measurement of thermal comfort in the vehicles with a new thermal manikin*. SAE technical paper series 931958. 7:th International pacific conference and exposition on automotive engineering. Phoenix, 1993.
- Mayer E. *Thermische Behaglichkeit in Räumen - Neue Beurteilungs- und Messmöglichkeiten*. Sonderdruck aus Gesundheits-Ingenieur – gi 110. 1989.
- Mayer E., Ifrim C. *Mässung der feuchten Wärmeabgabe mit einer trockenen künstlichen haut*. Sonderdruck aus Luft- und Kältetechnik 33. 1997.
- Melikov, A., Zhou, H. *Measurements of thermal comfort for well-defined conditions in a climatic chamber*. EQUIV Report No 2. Technical University of Denmark, Copenhagen, 1999.
- Nilsson H., Holmér I., Bohm M., Norén O. *Equivalent temperature and thermal sensation – Comparison with subjective responses*. 4:th International Conference on Comfort in the Automotive Industry, Bologna, 1997.
- Nilsson, H. *Field tests of instruments used to measure equivalent temperature*. EQUIV Report No 5. National Institute for Working Life. Solna. 1999.
- Nilsson, H., Holmér, I. *Definition and measurements of equivalent temperature*. EQUIV Report No 1. National Institute for Working Life, Solna, 1999.
- Olesen B.W. *Measurement of thermal comfort in vehicles*. Brüel & Kjaer application notes.
- SAE J2234 Issued Jan93. *Equivalent temperature*. SAE technical reports.
- Schwab, R, Conrad, W., Mayer, E. *Correlation between objective and subjective measurements of thermal comfort*. EQUIV Report No 4.1. Fraunhofer Gesellschaft, Institut für bauphysik. Holzkirchen. 1998.
- Wyon, D., Norin, F. *The effects of moderate heat on driver vigilance in a moving vehicle. Strategic highway research program, traffic safety on two continents*. Gothenburg, 1991.
- Zimny, K., Dömök, S. *Comparison of measured t_{eq} with t_{eq} calculated by a computer program*. BMW – AG. München. 1998.

The use of thermal manikin in the field

Håkan O. Nilsson

Climate Research Group, National Institute for Working Life
Solna, Sweden

Objectives

In this study road and rail tests have been carried out. Tests have been made under both summer and winter conditions. The objectives were to study the various methods used in the previous work packages in order to compare and compare them under field conditions. Very important is to evaluate the practical usability, robustness, sensitivity, etc. under active service conditions.



Figure 1. Map over Europe with test locations.

Equipment and experimental conditions

The first field tests were carried out in Zaragoza, Spain, in the summer of 1997. The Scania Corporation provided two Scania trucks, drivers and technical support during the tests. The trucks were driven on the highway from Zaragoza to Barcelona, both before and after sunset. The climatic parameters, trucks and conditions and equivalent temperature determined by the different methods were recorded during the field tests.

The road tests in winter climate has been carried out by Volvo Truck Corporation. They performed the tests in their own trucks at their own test

facilities outside Jokkmokk in January 1998. Ventilated seats from Be-Ge Industries was mounted at both driver and passenger position in the trucks. The truck corporation provided the project with vehicles and drivers. They also collected data concerning the weather and cabin conditions during the tests.

The rail tests in Paris were carried out during the February and July 1998 in “Metro de Paris”. RATP provided trains and drivers. The RER test wagon was positioned in the middle of the train with the instruments in driver position. For technical reasons both cabins could not be used in the same time on the METRO train. Consequently one test was made with the presence of a driver and the other without.

In the summer and winter tests with trucks ventilated seats from Be-Ge Industries was mounted at both driver and passenger position in the trucks. The corporations provided the project with vehicles and drivers. They also collected data concerning the weather and cabin conditions during the tests. The owners of the instruments tested has been responsible for preparing the instruments for the tests, installing them in the trucks and for collecting data. During the tests documentation by photo and video has been made by the companies. They also collected data concerning the weather conditions during the tests. They supplied electrical power of 220 volt, 500 VA. Calibration of the instruments had been made in the laboratories before delivery to the test site. Calibration control was made in a ordinary room at the place for the tests, with a temperature close to 24°C and as low an airspeed as possible.



Figure 2. Measurements with the Artificial Skin inside a Scania truck in Zaragoza.

Equipment:

Zaragoza

Vehicles: 2 Identical Scania 144L 450 trucks
Instruments: NILLE dressed/undressed, 6 Comfort meters, Artificial skin, Discomfort meter, Physical instruments (temperatures)
Time used: 28/6-3/7, 1997, Zaragoza, Spain
1 day for preparation, 4 consecutive days for measurements
Outside temp: before sunset, 17 to 25°C
after sunset, 15 to 19°C

Jokkmokk

Vehicles: 2 Identical Volvo F12 trucks
Instruments: AIMAN dressed, 6 Comfort meters, Artificial skin, Discomfort meter, Physical instruments (temperatures)
Time used: 27/1-30/1, 1998, Jokkmokk, Sweden
1 day for preparation, 3 consecutive days for measurements (two for each instrument)
Outside temp: -10 to -23 °C

Paris

Vehicles: RER line A. MI 84 engine 8406 (Torcy-Chessy-Torcy), METRO (Vincennes-La Défense-Vincennes)
Instruments: HEATMAN dressed, EVA Hot film sensors, 6 Comfort meters, Artificial skin, Discomfort meter, Physical instruments (temperatures)
Time used: 16/2-20/2 and 6/7-10/7, 1998, Paris, France
4+4 days for measurements
Outside temp: in winter, 7 to 14°C in open air and 16 to 20°C underground
in summer, 14 to 21°C in open air and 22 to 27°C underground

The HVAC-system was adjusted for best comfort at the start of the project. All instruments was tested with the same settings of the HVAC-system. The tests were made at as steady conditions as possible. Tests were made with and without ventilation of the seat when available.



Figure 3. The thermal manikin AIMAN inside the Volvo truck in Jokkmokk.

Experimental plans

Measurements by the manikin were recorded. The installation in the field was assessed and documented. A video film was produced and photos were taken during the tests.



Figure 4. The EVA III sensors inside a RER train in Paris.

Abbreviations:

TMN Thermal manikin (NILLE dressed/undressed)

TMA Thermal manikin (AIMAN dressed)

TMH Thermal manikin (HEATMAN undressed)

HFS Hot film sensor (positioned on EVA dummy)

PI Physical instruments

V Ventilation

H Heating

C Cooling

Table 1. Field experiments

Day	With/Without	Before sunset					After sunset				
		TMN	CM	SE	LD	PI	TMN	CM	SE	LD	PI
	Ventilated seat										
28/jun			<i>P</i>	<i>R</i>	<i>E</i>	<i>T</i>	<i>E</i>	<i>S</i>	<i>T</i>	<i>S</i>	
30/jun	without	T1		T2	T2	T1					T1
	with	T1		T2	T2		T1		T2	T2	
01/jul	without		T1	T2	T2	T1		T1	T2	T2	T1
02/jul	without	T1	T2			T2	T1	T2			T2
	with	T1					T1	T2			T2
03/jul	without	T1	T2			T2					
	with	T1	T2			T2					

Day	With/Without	Jokkmokk to Boden					Boden to Jokkmokk				
		TM	CM	SE	LD	PI	TM	CM	SE	LD	PI
	Ventilated seat										
27/jan			<i>P</i>	<i>R</i>	<i>E</i>	<i>T</i>	<i>E</i>	<i>S</i>	<i>T</i>	<i>S</i>	
28/jan	without	T1		T2	T2	T1					T1
	with						T1		T2	T2	
29/jan	without		T1	T2	T2	T2		T1	T2	T2	T2
30/jan	without	T1	T2				T1	T2			

Day	With/Without	RER					Metro				
		TMH	CM	SE	LD	HFS	TMH	CM	SE	LD	HFS
	Ventilated seat										
17/feb	without			V/H	V/H						
18/feb	without		V/H			V/H					
19/feb	without								V/H	V/H	V/H
20/feb	without						V/H	V/H			
08/jul	without	C/V	C			C/V					
09/jul	without							C		C	C/V
10/jul	without						C/V				

Results

Different vehicles have different ventilation systems and their performance is not identical. The objective of this study was to gain field experience with methods for evaluation of the thermal environment in vehicles. It means that the different methods must be able to assess the performances of various ventilation systems in

vehicles. Only evaluating the steady state condition is not enough for practical use. In real life, some HVAC systems in vehicles, do not run under steady state conditions. Fluctuations of air temperature, air movement and radiation often exists. Methods for determination of equivalent temperature under transient conditions need to be developed and studied.

A very important task of these field tests was to evaluate the practical usability, robustness, sensitivity of different instruments under active service conditions. Some of the experiences from these field tests were: TM (Thermal Manikin, NILLE, AIMAN, HEATMAN), HFS (Hot Film Sensors, EVA) Gives a lot of information whit many zones simultaneously measuring. The only instrument that detects the seat zones that obviously affects the drivers environmental feeling of the climate. The manikin regulation parameters can be changed to make a slower and more stable measurement.

Conclusions and experiences during field measurements

Vehicle designers need evaluation systems for steady state as well as dynamic conditions. Measurements in the field can substantially contribute to the knowledge and understanding of the parameters that have an impact on climate comfort inside a vehicle. Some of the instruments are not to day designed to register dynamic measurements as in field tests. Testing on the road, with direction changes and changes in cloudiness etc., have to be handled with care and knowledge about the different system properties. Furthermore is durability an important factor when using the different measurement systems in the field.

It is clear that more work have to be carried out concerning filed measurements of equivalent temperature. Areas that has to be explored are; reflecting and/or absorbing glazing, air flow inside the cabin, HVAC evaluation, ventilated seats, dynamic measurements and correlation to subjective evaluation.

Below are some of the conclusions and experiences that was gathered during the field tests in this project.

Not manual reading

Computer should be used to store data, not manual reading. This is not convenient in field tests

Difficult to measure while driving

Difficult to measure on the driver side while driving.

Easy handling

In general, both CM and the TMs are rather easy to handle in the field. It took between 10 to 20 minutes to install a manikin and it's controls in the cabin.

Difficulties reading the displays

Some difficulties reading the displays was experienced during the sunny conditions, as the sun at this time of the year goes low in northern Sweden.

Time to position instruments

The time to position the different instruments in the passenger seat, was all within 5 to 10 minutes and could be performed by a single person. They are all documented with video camera.

Single/continuous measurements

The TM did continuous measurements an 6 and 33 sites during the entire measurement runs.

Observations of conditions

Observations about weather, temperatures and climatic situations could only be done with TM.

Ventilated seats

The ventilated seats was only tested once since the only instrument detecting them, TM, did not have enough power to make measurements. It was noticed that, specially when coming in to the cabin from the cold, it was very unpleasant to use the ventilated seat in dry winter conditions. According to driver experience the ventilated seats could only be used during short periods of long driving. If you got in from the ambience at -20°C the cooling power very quickly got intolerable.

Possible seat solution

A possible solution to the problem should be to regulate the fan speed and heating of the seat from a temperature sensor in the seat. The regulation should be made so that in warm conditions only the fan worked and in cold conditions only the heater. In long driving periods the fan would go on shortly to lower the temperature slightly.

Different regulation constants

Experiments with different regulation constants for the manikin were made. With different constants it's obvious that the manikin can be either very fast or very slow. We believe that in sunny and transient conditions it's better to have a fast regulation to be able to detect quick changes. These constants differ from ordinary laboratory constants, where a very stable continuity is desired.

Radio transmission

Radio transmission could influence the instruments in the vehicle that is transmitting the radio message. Filtering for this can be made in the same fashion as filters for net frequencies already exists.

Power requirements

The TM with equipment took around 250 W in stable conditions during measurements. During the start-up phase the instruments could need up to double power. These requirements are minimised with preheating of the instruments. Normal power output without instruments are around 100 W in these conditions.

One person runs both CM and TM

One person can mount and run these instruments in two trucks simultaneously.

Acknowledgement

The EQUIV project was funded by the European Commission. Work package 5 was also funded by the Swedish Council for Work Life Research and the Swedish National Board for Industrial and Technical Development (NUTEK).

Literature

- Bohm, M, Holmér, I, Nilsson, H, Norén, O. *Use of a thermal manikin to improve the cab climate*. Report N. 94-D-041, Int. conf. on AgEng. Milano, 1994.
- Cisternino M. *EVA manikin - Operating Instruction Manual-Rev.2.0*. Fiat Research Centre Internal Document-June 1996.
- Holmér, I.; Nilsson, Bohm, M.; H.; Norén, O. *Evaluation of thermal environment in automotive vehicles*. 2:nd International Conference on Vehicle Comfort. Bologna, 1992.
- ISO/WD 13731, *Ergonomics of the thermal environment – Definitions, symbols and units*. ISO/TC 159/SC 5/WG 1. 1995.
- Madsen T.L., Olesen B., Reid K. New methods for evaluation of the thermal environment in automotive vehicles. *ASHRAE Transactions* 1986.
- Melikov, A., Zhou, H. *Measurements of thermal comfort for well-defined conditions in a climatic chamber*. EQUIV Report No 2. Technical University of Denmark, Copenhagen, 1999.
- Nilsson H., Holmér I., Bohm M., Norén O. *Equivalent temperature and thermal sensation – Comparison with subjective responses*. 4:th International Conference on Comfort in the Automotive Industry, Bologna, 1997.
- Nilsson, H. *Field tests of instruments used to measure equivalent temperature*. EQUIV Report No 5. National Institute for Working Life. Solna. 1999.
- Nilsson, H., Holmér, I. *Definition and measurements of equivalent temperature*. EQUIV Report No 1. National Institute for Working Life, Solna, 1999.
- SAE J2234 Issued Jan93. *Equivalent temperature*. SAE technical reports.
- Schwab, R, Conrad, W., Mayer, E. *Correlation between objective and subjective measurements of thermal comfort*. EQUIV Report No 4.1. Fraunhofer Gesellschaft, Institut für bauphysik. Holzkirchen. 1998.
- Wyon, D., Norin, F. *The effects of moderate heat on driver vigilance in a moving vehicle*. Strategic highway research program, traffic safety on two continents. Gothenburg, 1991.

Presentation of a Dummy REpresenting Suit for Simulation of huMAN heatloss (DRESSMAN)

Erhard Mayer
Fraunhofer-Institut für Bauphysik,
Holzkirchen, Germany

Physiological basis

Physiologists have proven that for sensing thermal discomfort we do not have any heat flux sensors but only so-called thermal sensors or receptors (Benzinger, 1979). These are nerve ends sensitive to temperature or change of temperature, located in the skin as well as in the brain (hypothalamus). Here a difference is made between cold-receptors and warm-receptors. Cold-receptors react stronger the lower temperatures are, beginning at a certain threshold-temperature, and warm-receptors react stronger the higher temperatures are, beginning at another certain threshold-temperature. Simplified sensation of thermal comfort (discomfort) can be explained objectively as follows. "Too cold" is sensed when skin temperature falls below a certain threshold-temperature. This can on the whole, be combined with freezing, or locally, e.g. by draught. Then cold-receptors in the skin react. "Too warm" is sensed centrally, non-directionally, when a certain threshold-temperature in the brain is surpassed and warm-receptors react combined with sweating. Warm-sensors in the skin and cold-sensors in the brain exist too, but don't contribute to the discomfort sensation.

Figure 1 elucidates this objective definition of thermal comfort. A healthy young man at rest, wearing only trunks was exposed to different environmental temperatures.

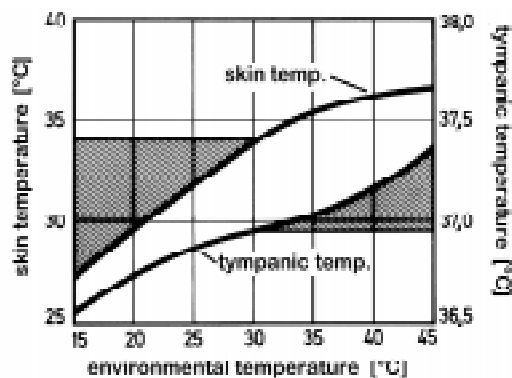

Figure 1. Skin and tympanic temperatures of a young man at rest, wearing only trunks exposed to different environmental temperatures. The shaded areas represent the uncomfortable conditions. Out of Benzing, 1979.

Average skin temperatures and central temperatures measured at the tympanic membrane were plotted against the environmental temperatures. In this case the threshold-temperatures were 34 °C for the skin and 37 °C for the brain. The

shaded areas represent the uncomfortable environmental temperatures: below 30 °C feeling too cold and beyond 30 °C feeling too warm, that means perfect thermal comfort at 30 °C.

Of course the temperature setpoints are not the same for every person, and time-dependent changes exist too.

Physical consequences

The above mentioned physiological principles especially the significance of skin temperature lead to practical physical consequences which are described as follows.

Heat balance equation

The heat loss from man in thermal comfort essentially consists of convection and radiation. Neglecting other heat losses for simplification e.g. by evaporation, heat balance e.g. for the forehead, can be formulated:

$$120\text{W/m}^2 = \underbrace{h_c \cdot (RST - t_a)}_{q_c} + \underbrace{\text{const} \cdot \left[\left(\frac{RST - 273.2}{100} \right)^4 - \left(\frac{t_{sf} - 273.2}{100} \right)^4 \right]}_{q_r} \text{W/m}^2$$

where

120 W/m ²	=	forehead heat flow resulting form normal metabolism (body resting)
q _c	=	convective heat loss
q _r	=	radiant heat loss
h _c	=	convective surface-heat transfer coefficient
RST	=	Resultant Surface Temperature, the surface temperature of the skin resulting from the thermal conditions of the body and the surrounding room, which according to [1] is decisive for cold discomfort.
t _a	=	air temperature
t _{sf}	=	temperature of the surrounding surfaces.

The decisive influence of the convective surface-heat transfer coefficient on thermal comfort becomes obvious when representing the formula in a graph, see Figure 2.

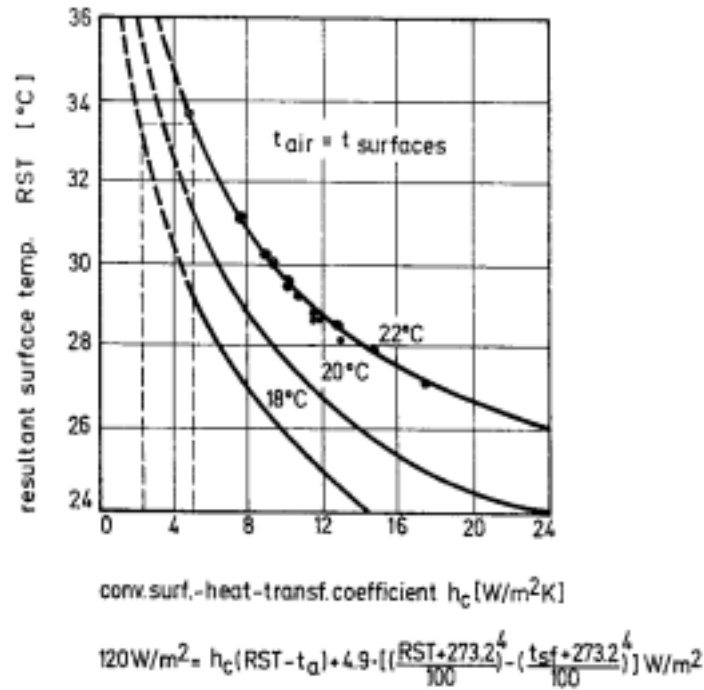

Figure 2. Resultant surface temperature RST as a function of the convective heat transfer coefficient h_c for ambient temperatures 18, 20 and 22 °C, according to the equation above (curves) and measured by the RST-meter (dots). In this case air temperatures t_a and temperatures of surrounding surfaces t_{sf} are the same. A similar figure can be drawn for differing air and surface temperatures.

Artificial skin, RST-meter

The heat balance can be simulated by an artificial skin as shown in Figure 3. It consists of an electrical surface resistor of defined area (middle), electrically heated at a constant rate of 120 W/m². To avoid unintended heat flows eight counter heaters and nine back counter heaters are installed. The value measured is the Resultant Surface Temperature (RST) which can be calculated from the measured electrical resistance and a calibration curve. The RST-meter is coated with a skin colour simulating the emission coefficient of the human skin. Results of the RST measurements at different air movements are plotted in Figure. 2 (dots).

To test the new indoor climate analyser it was used for investigations of thermal comfort conditions in cars correlating its results with the sensations of test persons.

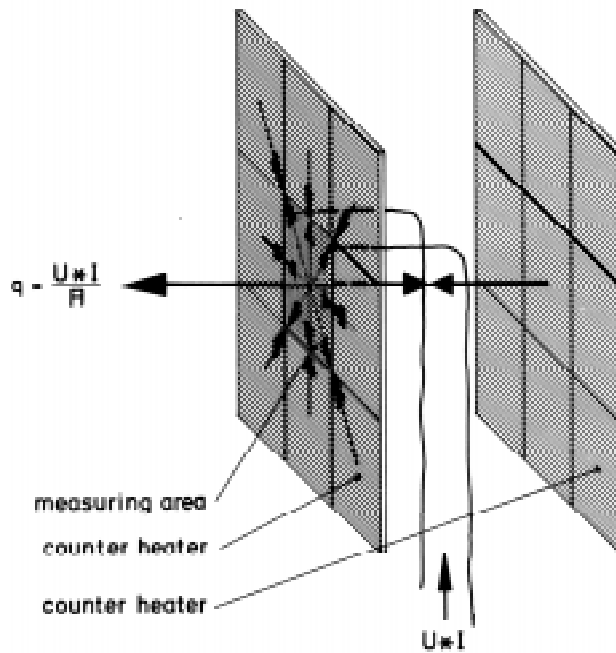

Figure 3. Schematic illustration of the artificial skin, RST-meter. Heating voltage U ; heating current I , size of measuring area A ; heat-flux density to the front, q .

In a simulated car the effect of solar radiation on thermal sensation was tested. Fifty test persons were exposed to typical thermal conditions in summer in Central Europe and asked for their thermal vote. Additionally, on seven parts of the body the artificial skin temperatures (RST) were measured. The correlation between the mean votes (MV) and the mean \bar{RST} values \bar{RST} are recorded in Figure 4. The following linear relation between mean vote and RST values can be stated:

$$MV = (0,184/^{\circ}\text{C}) \cdot (\bar{RST} - 30,6 \text{ }^{\circ}\text{C})$$

More details are published in (Mayer and Schwab, 1990).

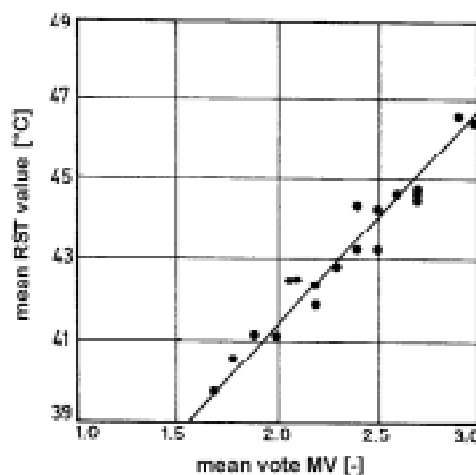

Figure 4. Mean artificial skin (RST)-values of seven parts of the body corresponding to mean votes of about 50 test persons, exposed to different thermal conditions in a car model (Mayer, E., Schwab, R., 1990).

Equivalent temperature

To get the equivalent temperature out of RST the heat balance equation of Figure 2 is needed. For a convective heat transfer coefficient h_c of resting air, which is about $2,5 \text{ W/m}^2\text{K}$, and equal temperatures of surrounding surfaces and air according to Figure 2, the equivalent temperature

$$t_{\text{equ}} = 1,1 \text{ RST} - 19,2 \text{ }^\circ\text{C}$$

Of course, this correlation (as well as Figure 2) will be different for another heat flux instead of 120 W/m^2 . For instance, at $22 \text{ }^\circ\text{C}$ room temperature and $h_c = 5 \text{ W/m}^2\text{K}$ the equivalent temperature is $18 \text{ }^\circ\text{C}$ (dashed line in Figure 2). Because t_{equ} includes all relevant physical quantities for thermal comfort under normal humidity conditions and because it easily can be calculated and measured as shown, this integral quantity should be used for standards in future.

Dressman

An application of these results is the development of a new type of thermal manikin. It consists of an overall – deliverable in different sizes which can be worn by a person or a manikin – on which up to 32 heated sensors can be fixed everywhere by velcro fastening, see Figure 5.



Figure 5. Dummy Representing Suit for Simulation of huMAN heatloss (DRESSMAN). Here six of the velcro fastened RST-meters can be seen. The white wires keep the air temperature sensors.

The heated sensors are matchbox-sized "artificial skins". These measure the Resultant Surface Temperatures (RST) resulting out of a constant heat flux and the thermal conditions. The local RST is linearly correlated to the local equivalent temperature and the human thermal sensation. More measurements to find out correlations between local RST/equivalent temperatures and local mean votes have to be done. The data transfer of the sensors to the PC is wireless.

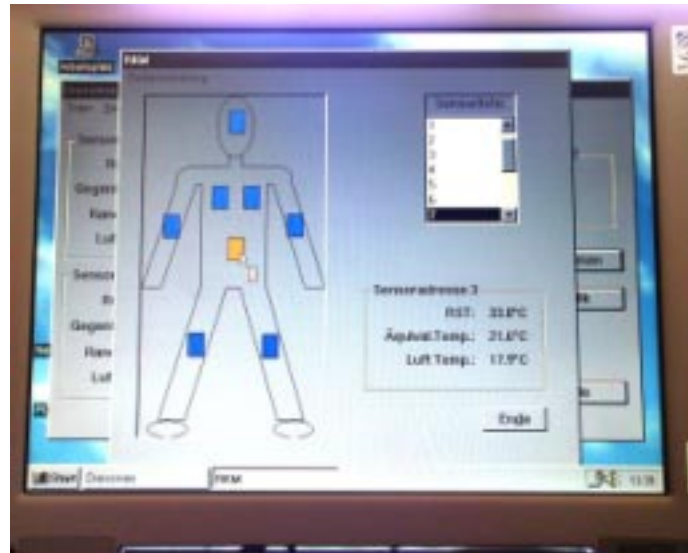

Figure 6. Display, window 1: available localisation of the sensors by mouse-click. For a quick view the RST-values are colour-coded.

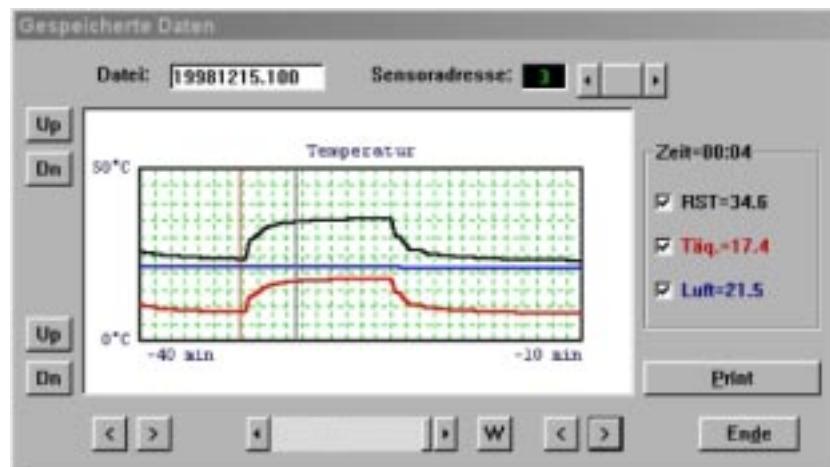

Figure 7. Display, window 2: RST, equivalent temperature and airtemperature curves of one sensor.

DRESSMAN should combine advantages of heated dummies (geometry) and of smaller sensors (small response time, local thermal conditions). It can be used in buildings as well as in transport vehicles. Two relevant PC-displays are presented in Figure 6 and 7.

References

- Benzinger, T.H. (1979). *The Physiological Basis for Thermal Comfort*. INDOOR CLIMATE, Danish Building Research Institute, Kopenhagen S. 441 – 474.
- Mayer, E., Schwab, R. (1990). *Raumklima in Kraftfahrzeugen bei Sonneneinstrahlung: Gegenüberstellung von physikalischer und subjektiver Bewertung*. DKV-Tagungsbericht 17, Band 4, S. 769 – 780.

Development of a breathing thermal manikin

Thomas Lund Madsen
Technical University of Denmark
Lyngby, Denmark

Introduction

In many years thermal manikins have been used to measure clothing insulation and to evaluate the thermal environment. In the recent years the interest for the indoor environment has been increased to involve not only the thermal, but also the air quality parameters. New units as olf and decipol has been developed, and is now used as often as the thermal parameters PMV and PPD (Fanger, 1988). This has increased the need for measurement of the air quality of the inhaled air to the human lung.

The Thermal Manikin

Thirty years experience with measurement of clothing insulation, and indoor thermal environment, is the background for construction of this thermal manikin (Olesen et al. 1983. Madsen et al. 1986. Tanabe et al. 1994).

The topic was to develop an instrument which is easy to use, and at the same time an instrument, which simulate as accurately as possible, the thermal reaction of a human being on the indoor environment.

The following parameters have been investigated:

A: Sex.

A female model has been chosen for the following reasons:

1. There is more variation in female than in male clothing. This gives more need for measurement of clo-values.
2. A female model is smaller and lighter and therefore easier to move in and out of for instance a car.
3. It is important for the measuring accuracy that the total heated surface is independent of the position of the manikin, seated or standing. This can most easily be obtained with a female model (Figure 1).

B: Mechanical Construction

The starting point has been an exhibition manikin made of fibre glass armed polystyrene. This material gives a light and mechanically strong construction with, a low thermal conductivity and a low thermal capacity. But these manikins are not made with normal human measures. There exist tables with measures for different sizes of women. They are used for design of female clothing. These measures are

means of measurements taken from several hundred typical Swedish women (Svenska Textilforskningsinstitutet, 1977).

From these tables is chosen the size 38, height 168 cm (a typical Scandinavian woman) and the exhibition manikin is changed to fulfill these measures. The manikin has movable junctions in neck, shoulder, hip and knee. The cut in the hip is made in a way so that the manikin is able both to stand and to be seated in natural position.

Experience from use of earlier thermal manikins has shown that the shoulder and hip were rather sensitive to movements perpendicular to the normal direction. If for instance the manikin was used by unexperienced people, they could very easily destroy especially the shoulder. Therefore in this new manikin a certain freedom is build in to move the arm and the thigh in all directions, (Figure 2). This seems to avoid the mentioned types of breakdowns.



Figure 1. The new generation thermal Manikin, showing the movability of the leg.



Figure 2. The arms are very movable to avoid destruction.

C: Physiological Simulation

It is extremely important that the manikin is able to react on the thermal environment in the same way as a human being in the same thermal situation. To be able to do this the manikin is divided in 16 thermally independent sections. Every section has its own control system designed to give the correct correlation between surface temperature and dry heat loss. This correlation is given in ASHRAE- as well as in ISO- standards. It is based on Fangers comfort equation.

D: Heating and Control System

A human being has thermal receptors all over the body for sensing warm as well as cold. For a correct simulation of that, the temperature sensing elements must be even distributed all over the manikin surface. This is obtained by a close winding of nickel wire on top of all 16 parts of the body shell. The distance between two wires is less than 2 mm. Measurement of the resistance of this wiring gives the mean surface temperature of the actual body part. The manikin is heated by the same wiring as used for measuring. This means that 100 times each second the computer changes between measuring and heating mode.

This heating and control system has several advantages

The use of the same wiring for measurement and heating, in connection with the position of wiring less than 0.5 mm below the surface, gives a very fast response on changes in the thermal environment.

If for instance a pair of trousers covers 50 % of the body surface, the other 50% is naked, then the “skin” temperature on the naked part will be lower and the heatloss higher, than on the part with trousers. This will give a more realistic clo-value than a measurement with constant surface temperature.

By means of a PID-controller the surface temperature can be set on an individually chosen, but fixed for each of the 16 parts.

Each of the 16 parts can also be set to a constant but individually chosen heat loss. These two settings (Bischof et. al., 1991, Tanabe et al. 1994) may further decrease the time constant.

E: The Artificial Lung (the Respirator)

In the recent years there has been an increasing interest for the air quality not only for health, but also for comfort reasons. A seated person creates, caused by her temperature field, an air movement up around the body. This air movement may transport pollution from the lower part of the room to the breathing zone. Dependant on the ventilation system, passive smoke in some places in a room can reach a concentration, which is unacceptable. In other words, there is a need to be able to measure the air quality exactly in the breathing zone.

In order to fulfill this goal, the new manikin can be connected to an artificial lung (Figure 3), which can create a normal breathing function through the nose and/or the mouth. The breathing intensity can be set from five to thirty l/min, and the breathing frequency can vary from six to thirty times per minute.

The inhailet air from the nose and/or the mouth can be transferred to any available analysing equipment for measurement of the air quality exactly in the breathing zone under realistic conditions.

In order to give a more realistic simulation of the exhailet air, the lung has recently been equipped with a small humidification and heating unit, so that the exhailet air leave the manikin with a correct temperature and humidity.



Figure 3. The rear side of the artificial lung, showing the six connectors. Two to inhaling and exhaling to and from the manikin. Two to and from the pump, one for inhalation of fresh air, and finally one to the analysing equipment. On top right is seen the connector to the computer from where the breathing volume and frequency are controlled.



Figure 4. The manikin inhale through the mouth and exhale through the nose.

References

- Bischof W., Madsen T.L. and Banhidi L. "*Physiological Adaptation of Thermal Manikins.*" ICHES'91. International Conference on Human – Environment System. December 1991. Tokyo, Japan.
- Fanger P.O. Introduction of the Olf and Decipol units to Quantify Air Pollution perceived by Humans Indoors and Outdoors. *Energy and Buildings, Vol 12, No 1 1988.* pp. 1-6
- Madsen T. L. and Olesen B. W. "A new Method for Evaluation of the Thermal Environment in Automotive Vehicles." *ASHRAE Transactions 1986, Vol.92, Part 1B* pp. 38-54.
- Olesen B. W. and Madsen T. L. "*Measurement of the Thermal Insulation of Clothings by a Movable thermal Manikin.*" Presented at the international Conference: Biophysical and Physiological Evaluation of Protective Clothing. L'Institute Textile de France, Lyon, France, July 1983.
- Svenska Textilforskningsinstitutet, TEFO, Konfektionindustriforeningen, KIF, Styrelsen for Teknisk Udvikling, STU's informationssektion, STU-udredning nr 70-1977. "*Storlekssystem for damkläder. Måttlistor och Marknadsandelstabeller.*"

Tanabe S., Arens E.A., Bauman F.S., Zhang H. and Madsen T.L. *"Evaluating Thermal Environments by Using a Thermal Manikin with Controlled Skin Surface Temperature"*. ASHRAE winter meeting, 1994, New Orleans, USA.

Simulation of human respiration with breathing thermal manikin

Erik Bjørn

Indoor Environmental Engineering, Aalborg University,
Aalborg, Denmark

Introduction

The human respiration contains carbon dioxide, bioeffluents, and perhaps virus or bacteria. People may also indulge in activities that produce contaminants, as for example tobacco smoking. For these reasons, the human respiration remains one of the main contributors to contamination of the indoor air. This paper describes the design of a new type of thermal manikin. In a number of experimental series, breathing thermal manikins have been used to investigate the role of the human respiration as a contaminant source in the indoor environment (Bjørn and Nielsen, 1996a, 1996b; Bjørn et.al., 1997). The same manikins were simultaneously used to assess personal exposure to exhaled contaminants. The design of these manikins has been used for air quality studies (Hatton and Awbi, 1998) with the consent of this author. The reason for using a thermal manikin for these purposes - rather than just adding contaminants through e.g. a simple jet - is that complicated interactions take place between respiration flow, thermal boundary layer flows, and thermal plumes. These may be studied in a realistic environment by using full-scale test rooms with life-sized breathing thermal manikins.

Design of breathing thermal manikin

The manikin is intended to simulate a Human Being in full-scale experiments in the sense of a flow obstacle, a heat source, and a contaminant source. Therefore, the following properties are made as realistic as possible, while still trying to keep down costs: External geometry, emissivity, total heat output, temperature distribution, exhalation flow. Since the manikin can inhale as well as exhale, it can also be used to measure contaminant exposure. The manikin consists of a hollow aluminum shell (thickness 1mm) covered with a coat of paint (to ensure correct transmission of radiative energy). The manikin is *not* intended for assessment of thermal comfort, as are some other thermal manikins.

Geometry

The manikin is composed entirely of simple geometrical shapes, thus making it relatively simple and cheap to produce, see Figure 1. The surface area is 1.44 m². For reasons of comparison, the external geometry of the manikin is designed to be as similar as possible to a thermal manikin from the Technical University of Denmark, which is also in the possession of the Indoor Environmental Engineering group at Aalborg University. The latter manikin is designed for

studies of thermal comfort. The geometry of both manikins are as close as possible to a size 38 woman as described in (STU, 1977).

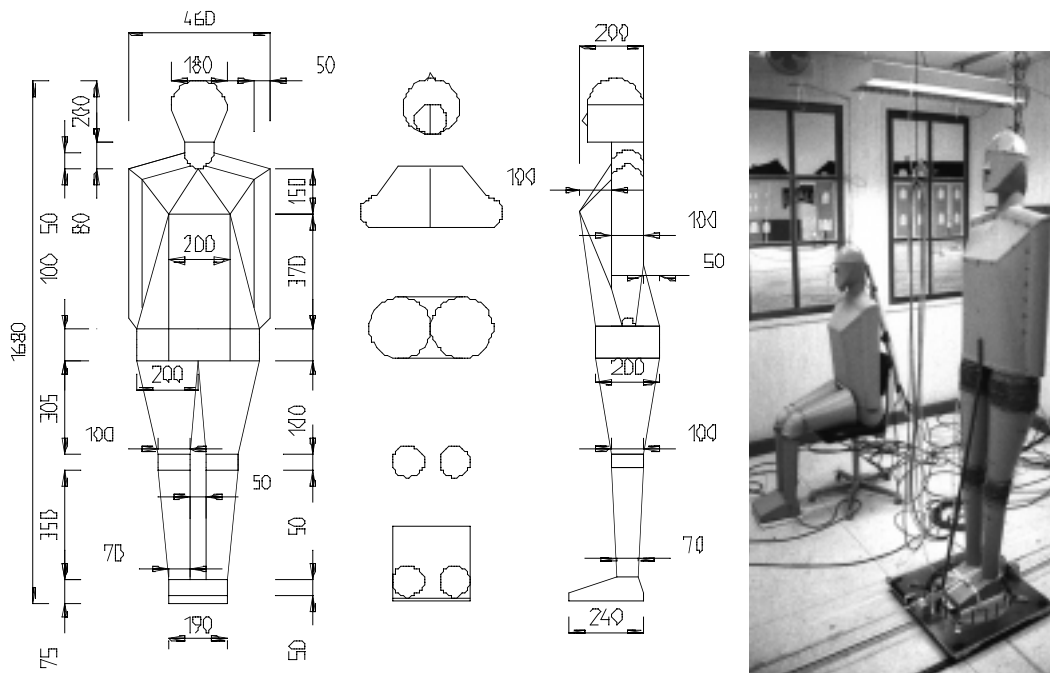

Figure 1. *Left:* Geometry of breathing thermal manikin. *Right:* Two breathing thermal manikins in full-scale test room. In this case, the upright standing manikin is attached to a trolley, which allows studies of the influence of movements.

Internal flow and temperature distribution

The torso of the manikin is divided by a vertical aluminum plate. The legs are separate. The arms are connected to the torso. In this way, the manikin is divided into two separate spaces or “ducts”, which are connected through the head and feet of the manikin. Inside it is equipped with two fans (one in each “duct”) forcing the air to circulate rapidly, and with 15 m of heating wire distributed evenly throughout the interior of the manikin, thus ensuring an even temperature distribution (approx. $\pm 1^\circ\text{C}$ at normal heat loads, with a tendency to have warmer head and torso, and colder legs). The convective heat transfer coefficient has been measured to be approx. $4.8 \text{ W}/^\circ\text{Cm}^2$, which is consistent with measurements of live persons.

Heat output

The total heat effect supplied to the manikin can be controlled between 0 - 400 W. In this way, one is not confined to realistic heat outputs, but can experiment with model conditions. The effect supplied to the fans and to the heating wire is measured separately.

Breathing function

The manikin is connected to an artificial “lung” that provides respiration through mouth and/or nose. The artificial lung consists simply of a cylinder with a piston driven by an electric motor. The pulmonary ventilation and respiration frequency

can be regulated in a wide range. Pulmonary ventilation for an adult at rest is approx. 6 liters pr. minute, at a respiration frequency of 10 - 12 breaths pr. minute. The air is exhaled from the nose of the manikin in two jets with direction ca. 45° below vertical, and with an intervening angle of ca. 30°. These are figures obtained from (Hyldgaard, 1994), who has measured this on his own exhalation. No studies have been found of larger populations. The nostrils consist of circular openings with diameter = 12 mm. This is close to the mean cross-sectional area of the nostrils of healthy adults according to (Grymer et.al., 1991). The mouth consists of a circular opening (diameter 12 mm). It is debatable what the cross-sectional area of the mouth should be, since this can obviously vary within a wide range. Some sensitivity studies of this parameter have been carried out by numerical methods in (Bjørn and Nielsen, 1998).

Density of exhaled air

A simple heating coil heats the air immediately before it enters the manikin. Due to the oscillating airflow, the exhalation temperature is not completely constant, but varies approx. $\pm 1^\circ\text{C}$. This oscillatory behavior is quite realistic. The mean exhalation temperature depends mainly on inhalation (i.e. ambient) temperature (P.Höppe, 1981). At an ambient temperature of 20, the mean temperature is approx. 32°C for exhalation through the nose, 34°C for exhalation through the mouth. Exhaled air has a different molecular composition compared to atmospheric air.

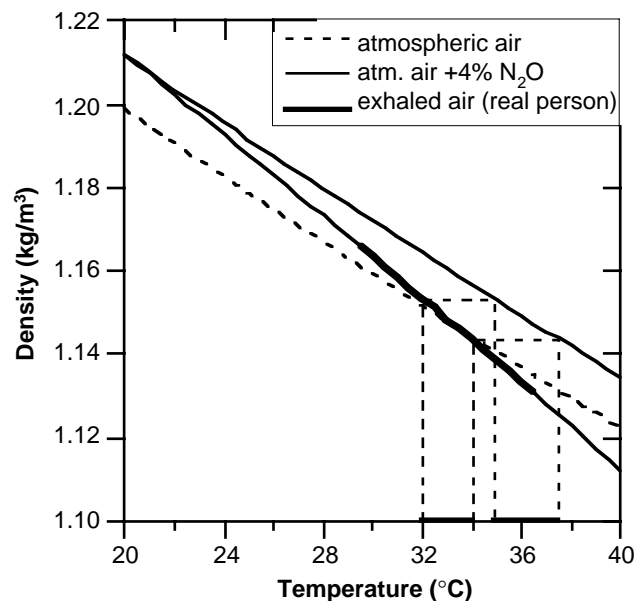

Figure 2. Influence of water vapour on density of exhaled air. Example: If one wishes to simulate exhaled air at 32°C using dry atmospheric air containing tracer gas N₂O, air temperature in experiments should be 35°C. (Pressure = 101325 Pa)

This has some consequences to the density of the air, which in turn will affect the buoyancy. In full-scale experiments, one will usually add a tracer gas to simulate contaminant (e.g. N₂O). Ideally, the exhaled air should also be saturated with water vapour. This may, however, have some unfortunate practical consequences,

as some gas analyzers (e.g. Binos 1.2, which was used in some experiments) are sensitive to changes in relative humidity. If the exhaled air is not saturated, the temperature should be corrected. An example is shown in Figure 2.

Discussion

A main problem in simulating respiration, and especially in simulating the exhalation flow, is the lack of empirical data from living persons. Extensive studies have been made by members of the medical profession, but almost without exception, the focus of these studies are on the internal workings of the respiratory system, often in connection with illnesses of some kind. This problem should be addressed in future research. In some instances – e.g. coughing and sneezing in hospital environments – it is probably important to simulate the movement of particles emitted from the exhalation. This subject also needs further attention. In most normal situations, people will move around more or less. Some preliminary studies have been made on this issue (Bjørn et.al, 1997). Much more can be done, however. A future objective of this worker is to include physical movements in manikin design: the breathing and moving thermal manikin.

Acknowledgement

This work has been supported financially by The Danish Technical Research Council (STVF) as part of the research programme of the International Centre for Indoor Environment and Energy.

References

- Bjørn, E. and Nielsen, P.V.: *Passive Smoking in a Displacement Ventilated Room*. Proceedings of Indoor Air '96, The 7th Int. Conf. on Indoor Air Quality and Climate, July 21 - 26, Nagoya, Japan, Vol. 1, pp. 887 - 892, 1996b.
- Bjørn, E. and Nielsen, P.V.: *Exposure Due to Interacting Air Flows between Two Persons*. Proceedings of Roomvent '96, 5th Int. Conf. on Air Distribution in Rooms, Yokohama, Japan, July 17 - 19, Vol. 1, pp. 107-114, 1996a.
- Bjørn, E., Mattsson, M., Sandberg, M., Nielsen, P.V.: *Displacement Ventilation - Effects of Movement and exhalation*. Proceedings of Healthy Buildings '96, 5th Int. Conf. on Healthy Buildings, 27 Sept- 3 Oct. 1997, Washington DC, USA, Vol. 2, pp. 163 - 168.
- Bjørn E, Nielsen P.V. (1998). "*CFD Simulations of Contaminant Transport between Two Breathing Persons*." Proc. ROOMVENT '98, 6th Int. Conf. on Air Distribution in Rooms, Stockholm, Sweden. Vol. 2, pp.133-140.
- Luisa F. Grymer et.al. (1991). "Acoustic rhinometry: Values from adults with subjective normal nasal patency".*Rhinology*, Vol. 29, 35-47.
- Hatton, A., Awbi, H.B.: *A Study of the Air quality in the Breathing Zone*. Proceedings of Roomvent '98, 6th Int. Conf. on Air Distribution in Rooms, Stockholm, Sweden, June 14-17 1998. Vol.2, pp.159-166.

- Haselton F.R., Sperandio P.G.N. (1988). "Convective Exchange between the Nose and the Atmosphere". *J.Appl.Physiol.* 64(6): 2575-2581.
- Hyldgaard C.E. (1994). "Humans as a source of heat and air pollution." Proceedings of Roomvent '94, 4th Int. Conference on Air Distribution in Rooms, Krakow, Poland.
- Höppe P. (1981). "Temperatures of Expired Air under Varying Climatic Conditions." *Int.J.Biometeor* vol.25, no.2, pp.127-132.
- STU-utredning nr 70-1977: *Storlekssystem för damkläder.* (In Swedish. "Size system for women's clothing")

Measurement of indoor air quality by means of a breathing thermal manikin

Henrik Brohus
Aalborg University, Sohngaardsholmsvej,
Aalborg, Denmark

Introduction

In order to assess the indoor air quality of a ventilated room it is necessary to know at least the pollution load and the air change rate. By means of a simple mass balance it is possible to determine the contaminant concentration of the return air. If the room air is completely mixed and possible concentration gradients are neglected the contaminant concentration throughout the room equals the return concentration. However, the assumption of complete mixing may cause erroneous assessment of the personal exposure if significant concentration gradients prevail for instance close to the pollution sources or in case of displacement ventilation (Brohus and Nielsen, 1996). Errors exceeding one order of magnitude are reported (Brohus, 1997).

When a person is located in a contaminant field with significant gradients the contaminant distribution is modified locally due to the entrainment and transport of room air in the human convective boundary layer as well as due to the effect of the person acting as an obstacle to the flow field, etc. The local modification of the concentration distribution may affect the personal exposure significantly and, thus, the indoor air quality actually experienced. In this paper measurements of indoor air quality by means of a Breathing Thermal Manikin (BTM) are presented.

Breathing thermal manikin

The BTM is shaped as a 1.7 m high average sized woman, developed from an anatomically correct female display manikin consisting of a fibreglass-armed polyester shell, See Figure 1. The shell is wound with nickel wire used sequentially both for the heating of the manikin and for measuring and controlling the skin temperature. The BTM is controlled to obtain a skin temperature and a heat output corresponding to people in thermal comfort (Tanabe et al., 1994). The BTM is wearing tight-fitting clothes with an insulation value of 0.8 clo. Respiration is simulated by means of an artificial lung.



Figure 1. Breathing Thermal Manikin (BTM) used to measure the indoor air quality.

Experimental set-up

Two different set-ups are examined in order to demonstrate the use of the BTM. CASE 1: Exposure to a point contaminant source in a uniform velocity field examined by means of the BTM located in a wind channel, see Figure 2. CASE 2: Personal exposure to emission from a “modelled carpet” located in a mock-up of a typical cell office, see Figure 3.

In both cases the contaminant source comprises nitrous oxide mixed with helium in order to obtain a density neutral tracer gas. In CASE 1 the tracer gas is supplied through a porous foam rubber ball, \varnothing 0,1 m. In CASE 2 the tracer gas is supplied through a perforated and branched plastic tube shaped as an H, located below a perforated plastic film covering the entire mock-up floor. The tracer gas concentration is measured by means of photoacoustic spectroscopy.

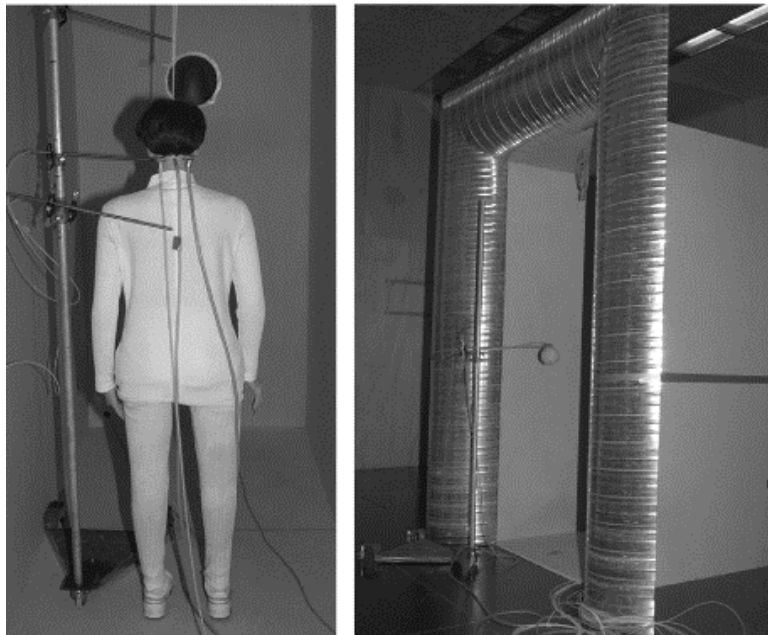

Figure 2. CASE 1. Personal exposure to a point contaminant source examined in the unidirectional flow field of a wind channel.

Results

The measurements performed in the wind channel on personal exposure to a passive point contaminant source in a uniform flow field are presented in Figure 4, showing the measured personal exposure for different vertical locations of the point contaminant source as a function of the velocity level when the source is located at a fixed horizontal distance of 0.5 m from the BTM. For more details see Brohus (1997).

Table 1 shows the results of indoor air quality measured by means of the BTM located in the office mock-up in case of the entire floor acting as a planar contaminant source. Apart from the personal exposure, c_e^* , the contaminant concentration at a neutral location in breathing zone height, c_p^* , is measured. Results from two different ventilation strategies are mentioned. During the old strategy the heating and the supply of fresh air are both provided by the ventilation system. The new strategy separates the heating and the supply of fresh air (isothermal ventilation and heating panels). For more details see Brohus and Hyldgaard, 1998 and Pejtersen et al., 1999.



Figure 3. CASE 2. Personal exposure to emission from a carpet in a typical cell office. *Left:* Mock-up seen from outside. *Right:* Mock-up seen from inside.

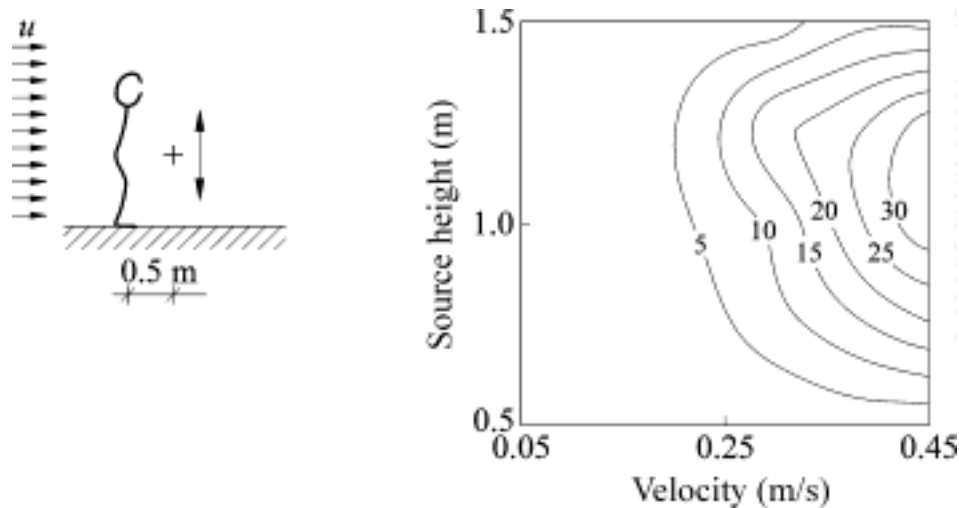

Figure 4. Results from CASE 1. Personal exposure, c_e^* , of the BTM standing in a uniform velocity field as a function of velocity level and vertical point source location above the floor. The results are made dimensionless by dividing by the contaminant concentration measured in the return opening of the wind channel.

Table 1. Results from CASE 2. c_e^* is measured by means of the BTM. c_p^* is measured in the centre of the office at a height of 1.1 m. The results are made dimensionless by dividing by the contaminant concentration measured in the return air.

Ventilation strategy	c_e^*	c_p^*
Old	2.37	1.17
New	1.18	1.06

Discussion

Figure 4 shows the results on personal exposure to a passive point contaminant source in a uniform flow field (CASE 1). The uniform flow field may also represent the local flow field around a person located in a mixing ventilated room. The contaminant source might represent for instance an ashtray. The case shows that the exposure depends strongly on both source location and velocity level. Dimensionless exposure levels exceeding 30 are found, i.e. the actual concentration of inhaled contaminant is 30 times higher than the concentration obtained if the assumption of complete mixing was applied. A distinct influence of the location relative to the wind direction and the contaminant source is reported by Brohus (1997).

The results from Table 1 (CASE 2) clearly show the importance of proper measuring equipment, here, in shape of the BTM. c_e^* and c_p^* are measured at the same height and the difference is due almost solely to the local influence of the person. In case of the old ventilation strategy, the personal exposure is twice as high as the return concentration and also twice as high as the corresponding concentration measured at a neutral location at breathing zone height. Obviously, the convection current along the thermal manikin entrains and transports contaminant from the floor area to the breathing zone.

The results of the full-scale exposure measurements by means of the Breathing Thermal Manikin show the importance of a proper tool for the assessment of indoor air quality in ventilated rooms where concentration gradients prevail. The human convective boundary layer is found to affect the local concentration distribution considerably together with the effect of the person acting as an obstacle to the general flow field.

Acknowledgement

This work has been supported financially by The Danish Technical Research Council (STVF) as part of the research programme of the International Centre for Indoor Environment and Energy.

References

- Brohus, H. (1997) Personal Exposure to Contaminant Sources in Ventilated Rooms, Ph.D.-thesis, ISSN 0902-7953 R9741, *Department of Building Technology and Structural Engineering*, Aalborg University, Denmark. Free download in pdf-format from http://iee.civil.auc.dk/i6/klima/publ-all.html#phd_diss
- Brohus, H. and Nielsen, P.V. (1996) Personal Exposure in Displacement Ventilated Rooms, *Indoor Air*, Vol. 6, No. 3, pp. 157 - 167.
- Brohus, H., Hyldgaard, C.E. (1998) The use of Tracer Gas Measurements in Detection and Solution of Indoor Air Quality Problems in a Danish Town Hall, *In: Moschandreas, D.J. (Ed.): Design, Construction, and Operation of Healthy Buildings: Solutions to Global and Regional Concerns*, ISBN 1-883413-66-4, pp. 57-66, *ASHRAE, Atlanta, GA, USA*.
- Pejtersen, J., Brohus, H., Hyldgaard, C.E., Nielsen, J.B., Valbjørn, O., Hauschildt, P., Kjærgaard, S.K., Wolkoff, P. (1999) *The Effect of Renovating an Office Building on Occupants' Comfort and Health*, Proceedings of Indoor Air 99, The 8th International Conference on Indoor Air Quality and Climate, Vol. 2, pp. 160-165, Edinburgh, Scotland.
- Tanabe, S., Arens, E.A., Bauman, F.S., Zhang, H., Madsen, T.L. (1994) Evaluating Thermal Environments by Using a Thermal Manikin with Controlled Skin Surface Temperature, *ASHRAE Transactions*, Vol. 100, Part 1, pp.39-48.

The importance of a thermal manikin as source and obstacle in full-scale experiments

Peter V. Nielsen
Aalborg University,
Aalborg, Denmark

Introduction

The thermal manikin is normally introduced at indoor environmental measurements to obtain detailed information on thermal comfort and air quality around a person. This paper deals with the opposite situation where manikins are introduced as sources and obstacles in order to obtain reasonable boundary conditions in experiments with the indoor environment. In other words, how will people influence the surroundings instead of how will the surroundings influence people? The use of thermal manikins in an experiment will of course take both situations into account, however, in some experiments the manikins are used mainly as sources and obstacles.

A person will influence the indoor environment due to heat transfer by conduction, free and forced convection, radiation and latent heat loss. The person is also an emission source of CO₂, water vapour, tobacco smoke and bioeffluent. Finally, a person will influence the room air movement due to flow resistance of the body and body movement, Brohus (1997). A manikin should be able to simulate those effects in situations where they are important for the final flow in the room.

The paper shows examples from displacement ventilation and mixing ventilation separately because the physical process in the two air distribution principles is different. Examples of the use of manikins in experiments with local ventilation will also be given in the last section of the paper.

Displacement ventilation

Thermal radiation plays an important role in the heat flow process in a room ventilated by displacement ventilation. Therefore, it is important to use heat sources similar to persons in experiments with this type of ventilation. Figure 1 shows the vertical temperature gradient for different heat sources. The point heat source is a small cylindrical heater with open heating elements, 0.3 m x 0.1^o m. The thermal manikin is a black painted cylinder with the dimensions 1.0 m x 0.4^o m.

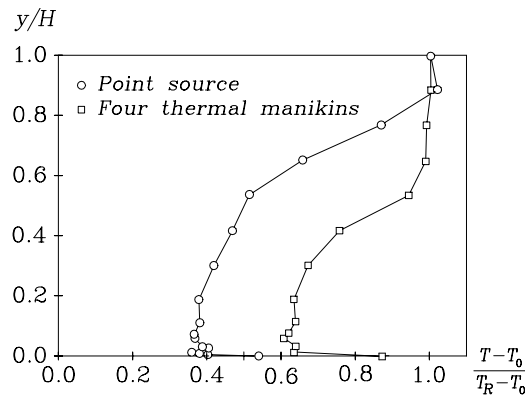

Figure 1. Vertical temperature gradients in a room with different heat sources. Nielsen (1993).

The location of the normalized temperature gradients in Figure 1 depends on the size and temperature of the heat source. A heat source as the point source will give a temperature distribution with relatively low temperatures in the occupied zone in comparison with the temperature in the return flow. Four thermal manikins generate a temperature distribution with a high level in the occupied zone and it is obvious from Figure 1 that it is impossible to use small point sources as person simulators in experiments with displacement ventilation.

The ratio of radiation to convection is an important parameter. A low ratio will displace the curves to the left because it will decrease the amount of heat supplied to the floor. Experiments with four thermal manikins (1.0 m x 0.4 m²) support this theory. Figure 2 shows how the vertical temperature profiles are displaced to the left-hand side of the figure when the emission is decreased. The low emission is obtained by covering the cylinders with aluminium foil, and the high emission (0.95) is obtained in the standard situation where the cylinders are painted black.

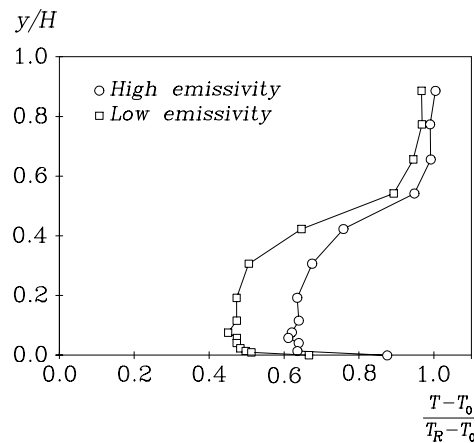

Figure 2. Vertical temperature gradients in a room with four thermal manikins which have a high and a low emissivity, Nielsen (1996).

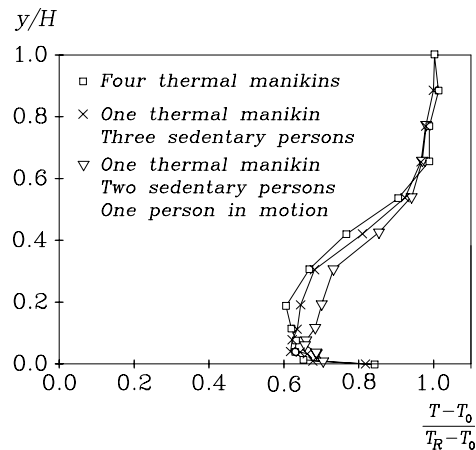

Figure 3. Vertical temperature gradients in a room with thermal manikins, sedentary persons and people in motion, Nielsen (1993).

Figure 3 shows the vertical temperature distribution in a room with thermal manikins and persons. The manikins seem to give a sufficiently thermal description of a person. It is especially important to notice that a moving person is unable to break the stratification and that the measurements show only a slight reduction in the effectiveness of the system. Other measurements made during great activity, and with an open door to the test room, do also confirm the stability of the stratified flow in the room.

Vertical concentration gradients in a room ventilated by displacement ventilation are influenced by people in motion as shown by Brohus and Nielsen (1994) and later in greater detail by Bjørn et al. (1997).

Exhalation is an important contaminant source when problems like passive smoking are considered. Bjørn and Nielsen (1996) have shown that the exhalation from a breathing thermal manikin will be concentrated in a horizontal layer with very high concentration, up to five times the fully mixed value for temperature gradients larger than 0.5 °C/m.

Mixing ventilation

Mixing ventilation is controlled by the momentum flow from the supply opening contrary to displacement ventilation where buoyancy and free convection are the main forces in the flow. The temperature distribution will therefore not be strongly influenced by the type of heat load, but the following experiments show that the velocity level and the maximum velocity in the room are influenced by people in the room.

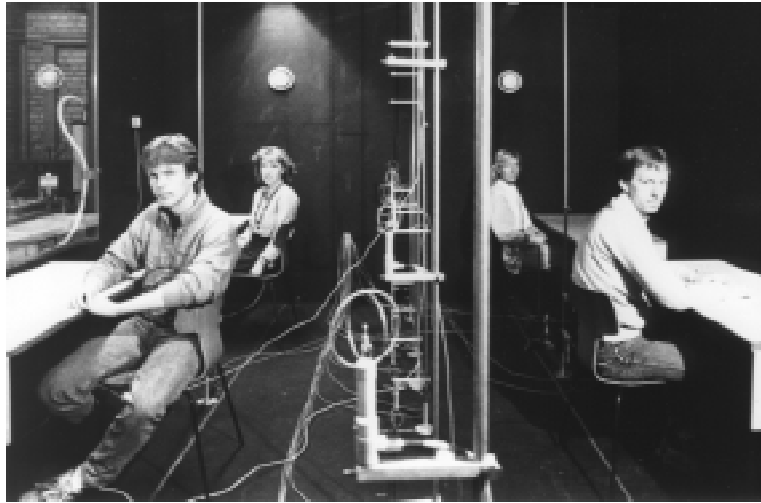

Figure 4. Full-scale room ventilated by mixing ventilation. Experiments with the influence of furniture, heat load and people.

Figure 4 shows a full-scale room installed with mixing ventilation. The maximum velocity in the occupied zone is measured at different air change rates in an empty room both without heat load and with a heat load of 600 W. The maximum velocity is also measured with furniture in the room and with furniture and people.

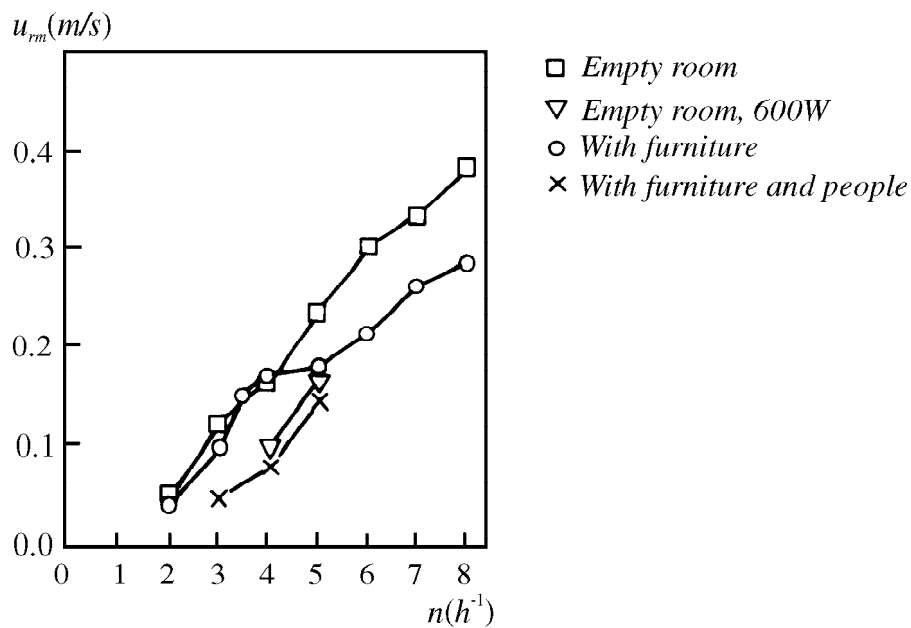

Figure 5. Maximum velocity in the occupied zone of a room versus air change rate.

The maximum velocity u_{rm} is linear proportional to the air change rate n for $n > 5$ due to the presence of a fully developed turbulence. Both the furniture and a heat load of 600 W will reduce the velocity level, see Figure 5, Heiselberg and Nielsen (1988). Four people in the room, as shown in Figure 4, will reduce the velocity to the level obtained in an empty room with a heat load, but it is not possible to decide if this effect mainly is due to heat emission from people in the room or if it

is due to restriction of the flow. Experiments by Nielsen et al. (1997 and 1998) show that obstacles as furniture and cold manikins will reduce the maximum velocity in the occupied zone of a room ventilated by mixing ventilation.

Local ventilation

It is often necessary to use thermal manikins in experiments with local ventilation because the size and heat emission from a person will be an important part of the whole process.

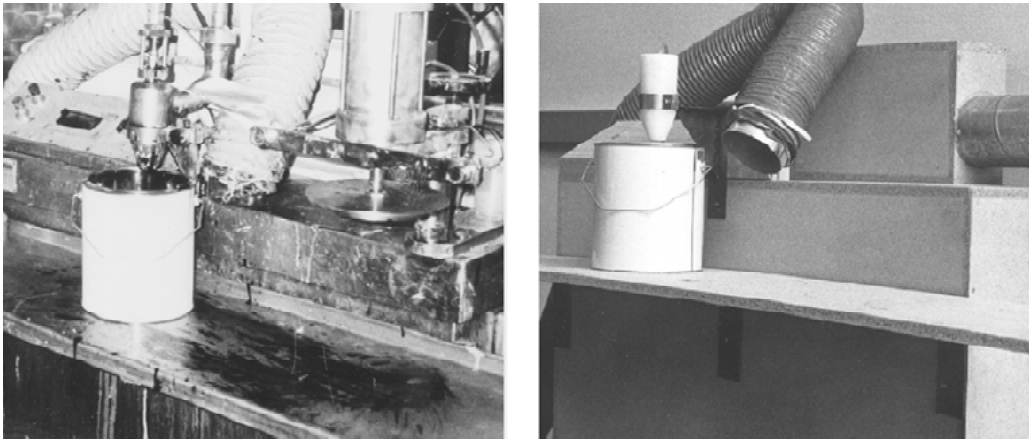

Figure 6. Filling machine from the paint industry and a full-scale model.

Experiments with an exhaust system on a full-scale model of a filling machine from the paint industry show that the use of a manikin has some significance. It was expected that the thermal boundary layer from the manikin would transport the contaminant away from the exhaust opening but the measurements show that the capture efficiency was slightly increased, probably due to a reduction of the flow area in front of the exhaust opening which causes an increase in the velocity level.

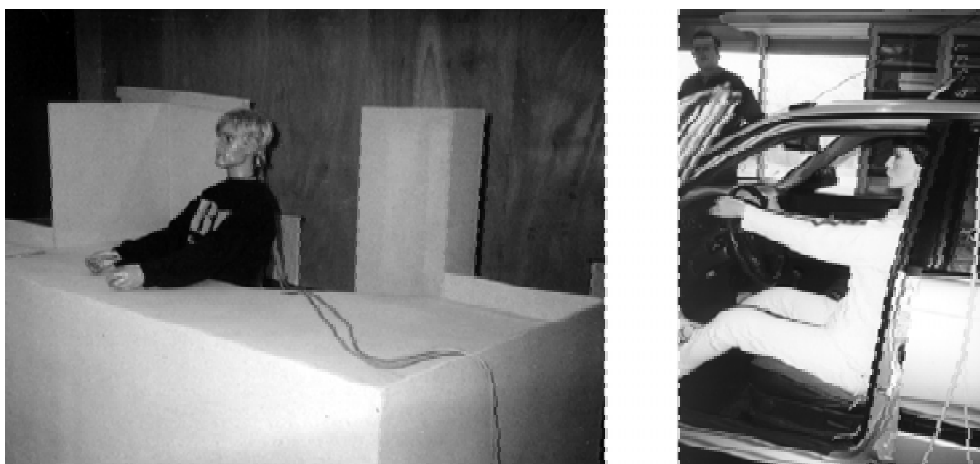

Figure 7. Determination of the comfort level at a checkout assistant's working area and in a car.

The experiment does not include the registration of personal exposure. However, new types of manikins with breathing functions are able to register these data.

Figure 7 shows two examples of experiments where thermal manikins are a necessary part of the set-up. The manikins are both used for measuring the comfort level and they do also serve as thermal load on the surroundings because in those situations the heat output from a person will influence the local temperature distribution.

Conclusion

The paper shows several examples where thermal manikins are important as necessary boundary conditions in the experiments. The flux of thermal radiation and free convection, exhalation and body movement are important in displacement ventilation, while thermal plumes and flow resistance are important in mixing ventilation. The geometry of the manikins and the heat output will always be important when experiments are performed within limited spaces, and the use of thermal manikins should be considered in all types of experiments.

Acknowledgement

This work has been supported financially by The Danish Technical Research Council (STVF) as part of the research programme of the International Centre for Indoor Environment and Energy.

Home page

Research work with breathing thermal manikins at Aalborg University is presented at: <http://iee.civil.auc.dk>

References

- Bjørn, E., Nielsen, P.V., 1996, *Passive Smoking in a Displacement Ventilated Room*, Proc. INDOOR AIR '96, Nagoya, Japan.
- Bjørn, E., Mattsson, M., Sandberg, M., Nielsen, P.V., 1997, *Displacement Ventilation - Effects of Movement and Exhalation*, Proc. Healthy Buildings '97, Washington DC, USA.
- Brohus, H. and Nielsen, P.V., 1994, *Contaminant Distribution Around Persons in Rooms Ventilated by Displacement Ventilation*, Proc. of ROOMVENT '94, Cracow, Poland.
- Brohus, H., 1997, *Personal Exposure to Contaminant Sources in Ventilated Rooms*, Ph.D. Thesis, ISSN 0902-7953 R9741, *Department of Building Technology and Structural Engineering, Aalborg University, Denmark*. Free download in pdf-format from http://iee.civil.auc.dk/i6/klima/publ-all.html#phd_diss

- Heiselberg, P., Nielsen, P.V., 1988, *Flow Conditions in a Mechanically Ventilated Room with a Convective Heat Source*, Proc. of the 9th AIVC Conference on Effective Ventilation, Gent, Belgium.
- Nielsen, J.R., Nielsen, P.V., Svidt, K., 1997, *Air Distribution in a Furnished Room Ventilated by Mixing Ventilation*, Proc. of Ventilation '97, Ottawa, Canada.
- Nielsen, J.R., Nielsen, P.V., Svidt, K., 1998, *The Influence of Furniture on Air Velocity in a Room - An Isothermal Case*, Proc. of ROOMVENT '98, Vol. 2, pp. 281-286, Stockholm, Sweden.
- Nielsen, P.V., 1993, *Air Distribution Systems - Room Air Movement and Ventilation Effectiveness*, Proc. of the ISRACVE Conference, ASHRAE.
- Nielsen, P.V., 1996, *Temperature Distribution in a Displacement Ventilated Room*, Proc. of ROOMVENT '96, Yokohama, Japan.

Extraction of data from sweating manikin tests

Harriet Meinander
VTT Chemical Technology,
Tampere, Finland

Introduction

The sweating thermal manikin Coppelius was developed in the 1980's within a Nordic project. The primary objective was to construct an instrument for the objective measurement of simultaneous heat and water vapour transmission through clothing systems. It has been in use at VTT in Tampere, Finland, for nearly 10 years, and is still the only known, truly and continuously evaporating thermal manikin in the world.

The measurements can be performed under different conditions, which have a great influence on the test results. The ambient temperature and humidity are more important in sweating than in dry tests. The absorption of moisture is generally a dynamic phenomena, and therefore the duration of the test influences the results. Infrared images during the tests might give additional information, which cannot be noticed in the measured values.

Basic construction of the sweating thermal manikin

The manikin construction is based on the Swedish dry manikin Tore, to which the sweating mechanism has been introduced. A number of sweat glands on the manikin surface supplies a controlled amount of water to the surface. Figure 1 shows the cross section of one sweat gland.

Water in liquid form is supplied to the skin material, which consists of two layers. The inner layer is highly wicking and spreads the water to a larger surface. The outer layer is a microporous membrane, which transmits water in vapour but not in liquid form. The heating underneath the skin evaporates the water, and heat and water vapour is thus produced from the manikin surface.

The manikin is suspended from a balance in the climatic chamber during the test, Figure 2. Thus the evaporation of moisture can be recorded as the difference between the supplied water and the weight increase of the manikin + clothing. Each item of the clothing is also weighed before and immediately after the test, to determine in which clothing layers the moisture is condensing.

Test procedure and examples of results

The test conditions are chosen to match the conditions where the clothing system is intended to be used, e.g. cold protective clothing in low temperatures and rain wear in high humidities.

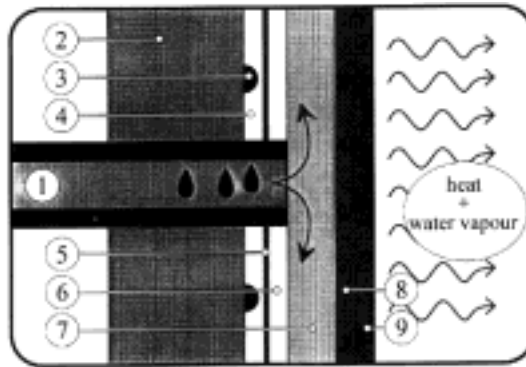

Figure 1. Cross section of a sweat gland (water supply 1, shell 2, heating wire 3, protective layers 4, 5, 6, 9, wicking layer 7, microporous layer 8).

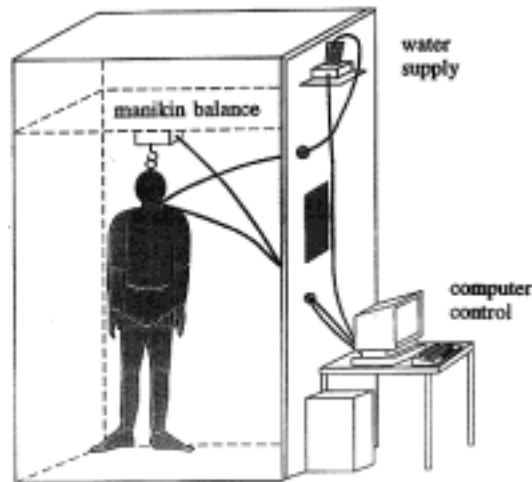

Figure 2. The sweating manikin in the climatic chamber, with water supply from the control room

A typical test procedure is as follows:

- weighing of the individual garments (dry weight)
- dry test, 2 hours (=> thermal insulation)
- sweating test, 3 hours
- weighing of the individual garments (wet weight).

During the test the following parameters are recorded: water supply, condensation and evaporation; surface temperature of all manikin body sections; temperatures at selected points; heat supply to all body sections; thermal insulation of all body sections. At the end of the test the following values are recorded or calculated: heat supply (sectional and mean) in W/m^2 ; thermal insulation (sectional and mean) in $m^2 \cdot ^\circ C/W$; moisture evaporation in $g/m^2 \cdot h$ or % of moisture supply; heat of evaporation in W/m^2 ; corrected thermal insulation in $m^2 \cdot ^\circ C/W$ and the moisture condensation in the individual garments. Figure 3 shows an example of the recorded moisture and thermal insulation values during the sweating test of a turnout suit for firefighters, and appendix 1 the corresponding final result sheet of the same test.

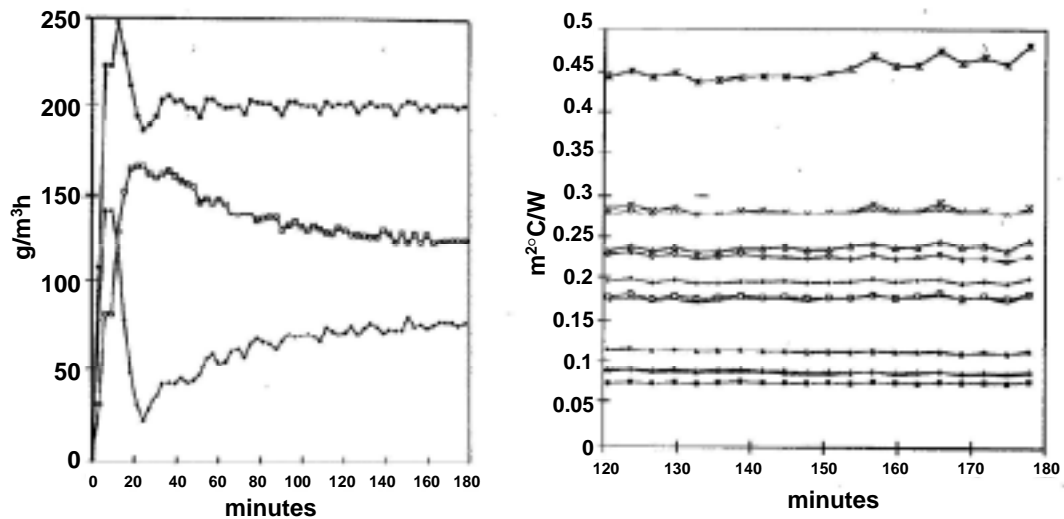

Figure 3. Recorded measurement values during a 180 min test: moisture supply, condensation and evaporation, and thermal insulation of the different body sections.

Tests performed on the same clothing system under different environment or sweating conditions give different results, due to differences in the moisture condensation. Figure 4 shows as an example the heat supply, thermal insulation and water vapour permeability values obtained from measurements of one clothing system for loggers.

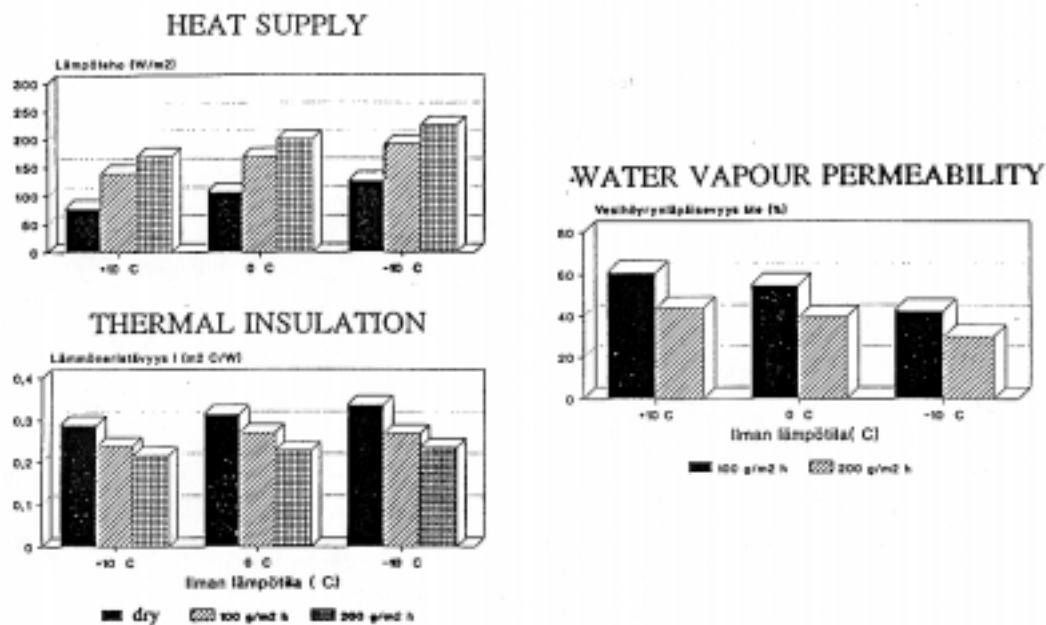

Figure 4. Heat supply, thermal insulation and water vapour transmission values for one clothing system measured under different temperature and sweating conditions.

The measurements were done in ambient temperatures of +10, 0 and -10 °C and with sweating levels of 0, 100 and 200 $\text{g/m}^3\text{h}$. The same general tendency can be seen in other results: when the temperature drops the values for heat supply and thermal insulation increase whereas the water vapour transmission decreases, and when the sweating level rises the values for heat supply increases and the thermal

insulation and water vapour transmission decrease. The difference in the results depending on the test conditions is however also depending on the type of clothing systems and the material combinations.

Presentation of the results

The large amount of data that can be used to show the properties for one clothing system is hard to be digested by customers. Generally one figure would be preferred, to show if the product is better or worse than that of the competitors. The development of mathematical models for the estimation of the performance of the clothing in different conditions, based on measured values in a basic set of conditions would be helpful and reduce the need for repeated tests.

Result sheet example on next page.

COPPELIUS

Description: Sammutuspuku 2R, +20C / 40%
Date: 15.6.95 **Signature:** al

Experiment file: E:\LW\MCS\HAAMA.MCE

	Set	Meas
Ambient temperature (°C)		20.7
Water Supply (g/m ² h)	200.0	
Test Time (h)	3.00	
Expired time (h)		3.00
Feeded water (g)		839.2
Condensed water (g)		585.0
Heat supply (W/m ²)		74.8

Results

Thermal insulation, all (m ² °C/W)	0.213
Thermal insulation, sweating (m ² °C/W)	0.221
Average evaporation (g/hm ²)	74.5
Heat of evaporation (W/m ²)	51.0
Corr. Thermal insulation (m ² °C/W)	0.645

Results from sections

	A (m ²)	t _s	H	I _t
1 HeadUpper	0.051	33.0	160.8	0.077
2 Chest	0.173	32.9	68.7	0.178
3 Back	0.179	32.8	61.9	0.196
4 UpperarmLeft	0.104	33.0	54.4	0.227
5 LowerarmLeft	0.047	32.9	110.9	0.110
6 HandLeft	0.048	67.5	0.0	0.000
7 UpperarmRight	0.104	32.9	50.7	0.240
8 LowerarmRight	0.047	33.0	110.2	0.111
9 HandRight	0.048	67.3	0.0	0.000
10 Standing	0.040	33.0	43.3	0.285
11 LowerTorso	0.181	32.9	42.9	0.284
12 ThighRight	0.153	32.9	25.5	0.480
13 LegRight	0.117	33.0	139.8	0.088
14 FootRight	0.041	22.4	0.0	0.000
15 ThighLeft	0.153	33.0	68.9	0.178
16 LegLeft	0.118	33.0	143.6	0.086
17 FootLeft	0.041	22.3	0.0	0.000
18 HeadLower	0.074	67.5	0.0	0.000

Weighed mean, sweating	1.417
Weighed mean, heated	1.466
Weighed mean, all	1.718

Use sweating articulated manikin SAM for thermophysiological assessment of complete garments

Niklaus Mattle

Swiss Federal Laboratories for Materials Testing and Research, EMPA,
St. Gallen, Switzerland

Like many others, EMPA also uses a sweating guarded hot plate for the assessment of water vapour and thermal resistance of material samples. In the last years some new test equipment has been developed to allow the measurement of protective and comfort properties of clothing under more realistic conditions.

With JAMES, our manikin in the raintower, we assess the rainproofness of complete garments. The rain is falling either from 3m height with 40 and 100 l/m²h or from 10m height with 450 l/m²h. 22 sensors on the manikin show where and when water goes through the garment.

With the sweating and moving arm we test jacket sleeves influenced by air layers and body movement. Each of the five sections is separately heated and temperature controlled. 20 sweating nozzles distribute water to a cotton fabric, which can be covered by a cellophane foil, if only water vapour is desired to pass through. The forearm can be moved up and down.

Our sweating torso with the dimensions of a human trunk and also similar thermal properties enables analysing of transient processes on clothing, sleeping bags, beddings and encasings. The measuring part of the torso is a cylinder of 300 mm in diameter. Distributed over it there are 36 sweating nozzles, each of them can be activated separately. Last year, EMPA has manufactured two more torsi with some modifications and already put them in operation. They each have 54 sweating nozzles and 13 temperature sensors. The torsi can be run at constant temperature or at constant heating power.

With our new sweating head, named ALEX, we will measure the comfort properties of helmets for cyclists and motorbikers. The head is divided in three sections with separate heating and temperature measurement winding. There are 25 sweating nozzles distributed over the head. We can place it in a new wind tunnel, which allows wind speeds of up to 40 m/s.

As a consequent continuation, EMPA decided to develop a sweating and moving manikin to measure complete garments and clothing systems. This development is carried out and financed by an international cooperation of material producers, garment manufacturers and end users.

The manikin will have the size and shape of an average human being. On an inner metal skeleton 26 shellparts will be mounted. Each of this plastic shells is molded with embedded connection flanges for fixing it onto the skeleton. They will have a heating wiring on the inner and a measuring wiring on the outer surface. Also a certain numbers of sweating nozzles are mounted, depending of the surface area and the sweat rate for this bodypart. A combination of two fabrics spreads the water very quickly, but no drops can leave the water outlet unless the inner fabric is wetted thoroughly. All over the body of SAM there will be a total of 128 sweating nozzles to produce evaporated or liquid sweating of up to 1 l/m²h.

Joints at shoulders, elbows, hips and knees make SAM movable. Arms and legs are driven by an external mechanism, which allows simulation of various human-like walking-profiles with a variable speed of up to 8 km/h. By this the influence of microclimate ventilation, openings and other manufacturing details of the clothing can be studied.

Validation tests with test persons are absolutely necessary but very time-consuming. In order to cover most of the future applications of SAM we have selected three clothing categories with three different clothing systems in each. These nine systems will represent a high, medium and low physiological stress to the test person.

In the category 'firefighters clothing' we have chosen a clothing with a compact PVC-coating, a clothing with a water vapour permeable material and a station wear with a high comfort but low protection. The second category includes cold protection clothing and workwear: There is a system for working at temperature below -20°C , one for temperature at around 0°C (this could be a postman's winter uniform) and a normal workwear for room temperature. In the third category we use military combat clothing, one with AC protection, one with rain protection and a camouflage suit with T-shirt.

For the first category the tests have already been done: Six male students were engaged to test the three different fireman's clothing systems. Each test person had to carry out 3 tests with each of the 3 clothings. All tests were performed in a climatic chamber at 30°C , 50% relative humidity and with a wind speed of 2 m/s. After a rest period for the accommodation to the climatic conditions followed two exercise periods of 25 minutes each with walking on a treadmill at 5 km/h on a slope of 4%. For the last 15 minutes of each exercise period the subjects were exposed to an infrared radiation of 0.5 kW/m^2 . During the tests the rectal and nine skin temperatures along with heart and respiratory rates were assessed. Additionally the microclimate temperature and humidity were measured between underwear and the clothing at four defined points. The clothing items and subjects were weighed separately before and after each test and the subjects weight and various subjective perceptions were recorded seven times during the test. All the tests were performed during the morning. The interval of time between two tests with the same person lasted one week.

The averaged tests results will be used to help define the control of SAM for such clothings and climates. The same clothing systems used in the practice tests will later be measured with SAM.

At the time the manufacturing and assembling of SAM is under way. Programming, putting into operation, more validation tests and measurements with SAM will follow. We hope the complete equipment will be operable by the end of year 2000.

CYBOR sweating concept

Wolfgang Uedelhoven¹ and Bernhard Kurz²

¹ Bundeswehr Institute for Materials, Explosives, (WIWEB), Erding, Germany

² Institute for Applied Ergonomics (IfaErg), München, Germany

Introduction

Besides the basic requirements for hand and footwear, i.e. protection of hands and feet against environmental influences like heat, cold, water, shock and mechanical attack the microclimate inside shoes and gloves has to be considered as an important criterium for the wearing comfort. The prevention of the formation of excessive humidity inside a shoe will considerably reduce the formation of blisters (Herring, and Richie Jr., 1990); in addition to that a good thermal insulation or sufficient heat exchange can considerably improve the overall performance in extreme cold or hot environments, respectively. It is important, though, to dispose of reliable means to measure and optimize the climatic wearing comfort of hand and footwear.

Although there are numerous concepts known for a rather precise judgement of the thermal insulation properties of shoes and gloves (Björgsen), the simulation of the physiological sweating behaviour of body segments as hands and feet still seems to be problematic. There is a lack of testing devices which allow a closely physiology related simulation of sweating as a function of additional metabolic rate. Recent investigations (Uedelhoven, 1994) show, that not only the water and heat transfer resistance values of materials used for the production of gloves and shoes or of gloves and shoes themselves are relevant for the prediction of the wearing comfort. Dynamic changes of temperature and humidity as they occur during walking, as well as buffering and heat and humidity exchange capabilities of the whole hand or footwear system have also to be taken into account. Particularly simultaneous dynamic changes of temperature and humidity in rather tight fitting garments are difficult to simulate.

Method

CYBOR (for Cybernetic Body Regulation) is a thermophysiological simulation device for the judgement of climatic wearing comfort of hand and footwear (Uedelhoven et al., 1998. Kurz et al., 1998). The basic functional elements of the device are shown in Figure. 1.

Conditioned (heated and humidified) air is guided into a hand- or foot phantom and leaves it through its perforated surface. There are temperature and humidity sensors inside the phantom as well as between phantom and garment under test to control the climate inside the phantom and to control and measure temperature and humidity levels inside the garment respectively. The dry or humid heatflows leaving the garment as well as the phantom can also be measured by additional temperature/humidity sensors. The most important control device for a simulation

of continuous changing humidity levels is a fast switching valve ("bypass" in Figure. 1) close to the input of the phantom. By switching between dry and humid airflow fast changes of relative humidity inside the phantom can be achieved (Figure. 2).

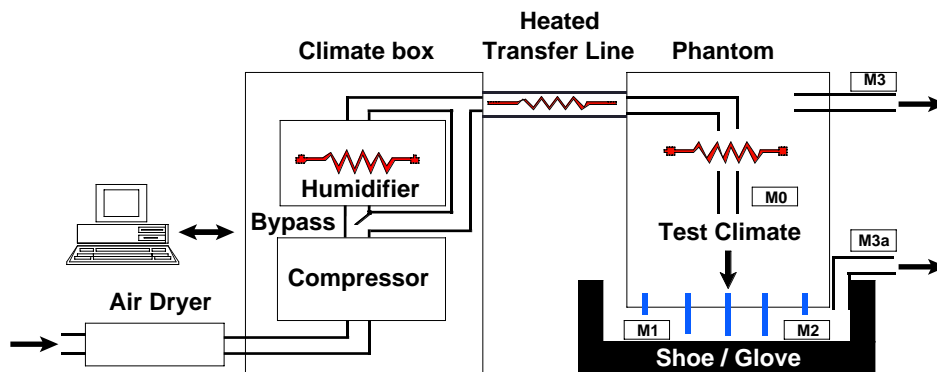

Figure 1. Simulation Device "CYBOR"; M0....3a: rh/T-sensors.

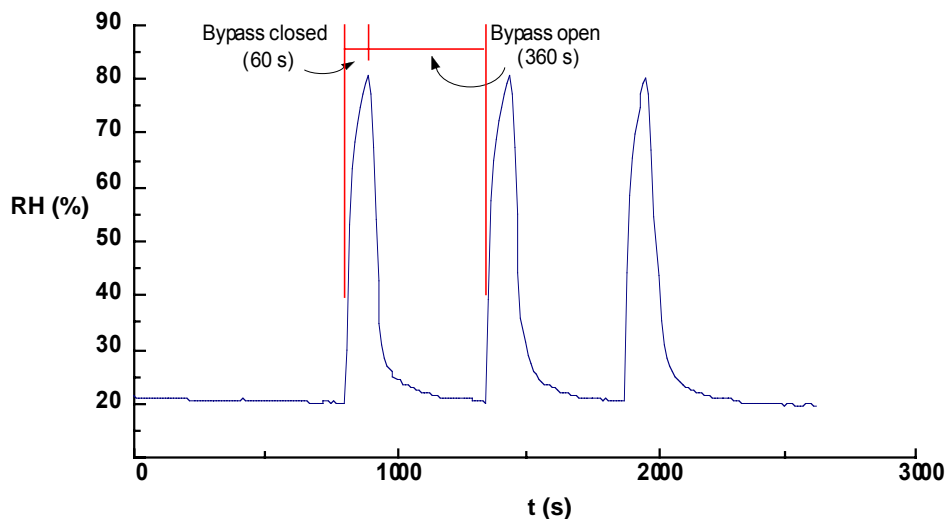

Figure 2. Changes of rel. humidity as a function of open/closed bypass valve

This control concept allows to follow predefined temperature/rel. humidity curves with a maximum deviation of ± 0.5 K for the temperature and ± 1 % r.h. for the relative humidity. This allows high precision measurements of the changing microclimate inside shoes and gloves during simulated walking/working tests. The effect of the footwear (handwear) system and all of its components on the climatic wearing comfort can be reliably estimated. An example of a comparative test of socks differing only in respect of the applied mixture of fibres is given in Figure. 3. The reference temperature and humidity curves for this simulation have been gained from T/r.h.-measurements during treadmill tests under defined varying workloads (Diebschlag et al., 1992).

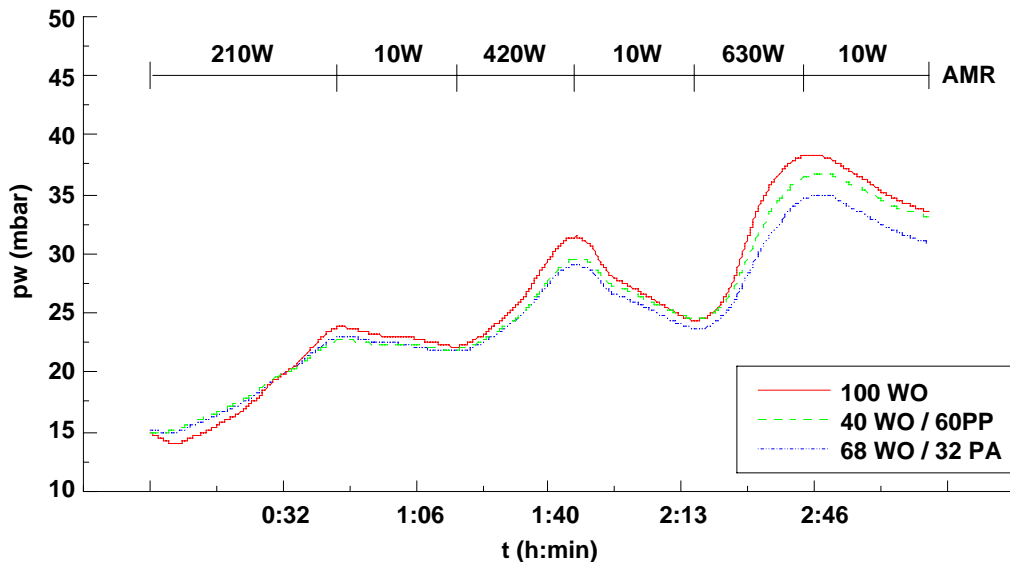

Figure 3. Comparative investigation of the microclimatic wearing comfort of socks. (WO = Wool, PP = Polypropylene, PA = Polyamide, AMR = additional metabolic rate, pw = water vapour partial pressure)

The measurement was carried out inside a regular combat boot at 16 °C outside temperature. The curves represent the water vapour partial pressure between the (phantom) foot and the sock in the medial section of the foot as a function of time and physiological workload. It can be seen that versus the end of the test there are obvious differences in the levels of the water vapour pressure.

Operating the testing device with humidified air instead of liquid water has a major advantage: When condensation inside the phantom can be avoided, there will be no heat loss caused by evaporation of liquid water within the system. Thus simple thermodynamic algorithms can be applied to calculate heat and water vapour resistance values of objects under test from the difference of in and outgoing dry and wet enthalpy streams (Kurz et al., 1998). Under the assumption, that humidified air is a mixture of two ideal gases (dry air and water vapour), enthalpies and mass flows can be calculated from the amounts of in and outgoing amounts of gas. The following parameters are needed for the calculation:

total enthalpy stream	h	[W]	(corresponds to total heat amount)
dry enthalpy stream	h_d	[W]	(corresponds to dry heat amount)
wet mass flow	m_h	[mg/s]	(corresponds to perspiration ratio).

The interaction with the clothing system can then be expressed as Δh , Δh_d and Δm_h .

There is no elevated air pressure within the system, because the excessive air leaves the phantom at the air outlet. It also has to be pointed out that no steam is used to produce the humidity inside the phantom; the humidification is done by guiding dried air through a waterbath with slightly elevated temperature.

Since all heaters and mass flows within the system are software controlled, it is relatively easy to add further features to the testing device. It is, for instance, possible to introduce defined heat and sweat rates into clothing systems. The idea behind this development was to only use one single setpoint for the simulation, the total heat amount Δh , which has to be discharged in the concerning body segment. The necessary amounts of dry and wet heatflows are determined by an adaptive fuzzy controller. Its algorithm is based on thermophysiological facts like the dependence of sweat gland activity to skin temperature or the influence of skin temperature on the possible amount of heat discharge. In order to consider the dependence of heat production and discharge of body segments from environmental temperature, physical workload, clothing insulation a.o., empirically found interdependencies can be established into a neuronal network (Kurz et al., 1998), thus making the simulation device a "learning system".

Conclusion

CYBOR has proved to be a powerful tool for a precise simulation and measurement of climatic conditions in hand and footwear systems and a reliable prediction of climatic wearing comfort. The system can easily be adapted to future medical knowledge and demands. The phantoms to be used with this testing device are, however, not limited to the shape of a hand or a foot. Other phantoms of body segments can be equipped with the same control concept. Thus CYBOR should become a helpful instrument for the judgement of climatic wearing comfort of underwear and top clothes as well.

References

- Björksen, Sweating foot, Sweating Thermal Hand System (STHS).
- Diebschlag, W., Heidinger F., Kurz B. & Droste R. 1992. Physiologic-experimental investigations on foot and handwear and construction of thermoregulative simulation devices. *Research Report No. BA V2 E/B52B/I0177/15944 Federal Office for Military Technology and Procurement.*
- Herring, K.M. & Richie Jr. D.H. 1990. Friction blisters and sock fibre composition, a double blind study. *Journal of the American Podiatric Medical Association*, 80, No. 2.
- Kurz, B., Uedelhoven, W.H. & Nocker, W. 1998. Cybor concept for thermophysiological simulation of dry and wet heatflow. *Proceedings of the Eighth International Conference on Environmental Ergonomics* (San Diego), 110.
- Uedelhoven, W.H. & Kurz, B. 1998. Reliable Prediction of wearing comfort using improved simulation techniques. *Proceedings of the Eighth International Conference on Environmental Ergonomics* (San Diego), 88.
- Uedelhoven, W.H. 1994. Quantitative judgement of wearing comfort of hand-/foot-wear using a hand-/foot-model. *Proceedings of the Sixth International Conference on Environmental Ergonomics* (Montebello), 154-155.

One week sweating simulation test with a thermal foot model

K Kuklane^{1,2}, I Holmér¹, G Giesbrecht³

¹National Institute for Working Life, Solna, Sweden

²Luleå University of Technology, Dept. of Industrial Ergonomics, Luleå, Sweden

³University of Manitoba, Lab. for Exercise and Env. Medicine, Winnipeg, Canada

Introduction

There are several thermal manikins available or under construction that allow the simulation of sweating (Giblo, Wajda, Avellini, & Burke 1998; Meinander 1992; Weder 1997). Similar thermal models are available also for particular body parts, for example, head, hand and foot (Burke 1998; Kuklane, Nilsson, Holmér, & Liu 1997; Liu & Holmér 1997; Uedelhoven & Kurz 1998).

Various sweating systems are in use. A thermal manikin Coppelius (Meinander 1992) uses a microporous membrane that transmits water only in vapour form. Liu & Holmér (1997) used cotton skin on model surface. The water is distributed in liquid form. It evaporates from the cotton surface or is transported further by clothing fibres. This method allows to simulate sweating also on ordinary thermal models when tubing is added to transport water and a material is added as skin for water distribution (Mahmoud 1997). The latest models are using heat pipe construction with a porous metallized skin (Giblo et al. 1998).

Quite a few studies have been carried out with thermal foot models (Bergquist & Holmér 1997; Santee & Endrusick 1988). Santee & Endrusick (1988) tested footwear insulation reduction due to the outside source (immersion). Some work has been done with the simulation of sweating (Kuklane & Holmér 1997; Kuklane & Holmér 1998; Uedelhoven & Kurz 1998).

Insulation reduction of footwear due to sweating has been shown to be relatively big (Kuklane & Holmér 1998; Kuklane, Holmér, & Giesbrecht 1999b). However, the length of most of the tests has been relatively short. (Kuklane et al. 1999b) tested the footwear over a whole day and looked at the change in insulation. The studies showed that the footwear did not dry out fully over night. A field test of military equipment has shown a big increase in weight of the footwear over 5-days period (Martini 1995).

This study aimed to find out how the insulation of the footwear changes over one week of use.

Methods

A thermal foot model with 8 measuring zones (1 - Toes; 2 - Mid-Sole; 3 - Heel; 4- Mid-Foot; 5 - Ankle; 6 - Lower Calf; 7 - Mid-Calf; 8 - Guard) and 5 "sweat glands" (3 built-in and 2 external made of PVC tubing) was used for tests. The "sweat glands" were located on toes, under sole and on medial ankle (built-in),

and on dorsal foot and lateral ankle (external tubing). A thin sock (70 % cotton and 30 % polyamid, weight ≈ 20 g) was donned on the model to allow better water distribution all over the foot surface. Simultaneously, additional insulation from that sock was relatively small (under 2 %). Each boot had its own sock.

Four boots were tested. WS was a warm boot of impregnated leather, with Thinsulate and nylon fur for insulation. WN was similar to WS, but it did not have a steel toe cap, and was made only for research purposes. SG and SM were extra warm footwear. SG consisted of 2 layers: outer shell of nylon with an insulation layer and a felt inner-boot. SM consisted of 3 layers: outer shell of nylon, and two layers of felt inner-boots. Some additional data on footwear is shown in Table 1. Boots similar to WS and WN are often used during work in winter time, and boots like SG and SM are used in very cold weather, often during hiking.

Table 1. Footwear.

Code	Model	Manufacturer	Weight (g)
WS	520	Stålex, Arbesko AB, Sweden	817
WN	520	Stålex, Arbesko AB, Sweden	817
SG	Glacier	Sorel, Kaufman, Canada	1285
SM	Mukluk	Sorel, Kaufman, Canada	1230



Figure 1. Measuring setup.

Each boot was tested for 5 days. Each day was divided into 9 hour measurement period and 15 hour conditioning period. Boots WS and WN were measured at -10.7 ± 0.9 °C and conditioned at room temperature (20.1 ± 0.5 °C, RH 39 ± 6 %). SG was measured at -20.8 ± 1.0 °C and conditioned in a refrigerator (simulating a temperature in a tent) at -5.0 ± 0.8 °C (RH 35 ± 6 %). Two series were carried out

with SM. In the first series it was conditioned in an insulated box in cold chamber and in the second series in the refrigerator. However, in the first series the cold chamber warmed up during night according to its working regime and the average conditioning temperature was 0.9 ± 4.1 °C (RH 78 ± 6 %). In here the tests with SM were carried out at -18.7 ± 0.8 °C. During second series it was measured at -20.8 ± 0.9 °C and conditioned at 2.8 ± 0.6 °C (RH 44 ± 9 %). The inner-boots and insoles of SG and SM were taken out over night. It should be noted that the refrigerator had a relatively good air circulation inside, and the air humidity reduced from about 70 % to 40 % within 2 -3 hours, while the relative humidity in the box increased and stayed for most of the time at about 80 %. In the end of the fifth measuring day the boots SG and SM were left at the room temperature (21.7 ± 0.5 °C, 48 ± 2 %).

The first measuring hour was without sweat simulation. During that time the heat losses stabilised and the start insulation of the day was calculated based on the last 10 minutes of that hour. During the following 8 hours the water was supplied with a peristaltic pump (Gilson Minipuls) at a rate of 5 g/h. It makes 1 g/h per "sweat gland" and 40 g of sweat per day in total, and 200 g of sweat per whole test period (5 days). The pump and water supply were located in an insulated box and water was transported in an insulated and heated tubing. On the fifth day of both SM tests only 4 "sweat glands" worked and thus was total water supply 32 g per day. Footwear was weighed in the beginning and end of each measurement day. The footwear insulation was calculated based on last 10 minutes of each half hour.

To simulate the real wear situation an up-down motion at 8 steps (with same foot) per minute was simulated with the help of a pneumatic system. Wind from front of 1.5 ± 0.5 m/s (measured at ankle level) was applied. The surface temperature of the foot was kept at 30 °C. The setup for measurements is shown in Figure 1.

Total insulation was calculated according to the following formula:

$$I_{t,r} = \frac{\bar{T}_s - T_a}{\sum P_i / \sum A_i}$$

where P_i - power to each zone, A_i - area of each zone; \bar{T}_s - mean surface temperature; T_a - ambient air temperature.

Results and discussion

The insulation change for each morning (start insulation of the day) is shown in Figure 2. The insulation change over one week (dry value in the morning of the first day and values for the end of each day) is shown in Figure 3. A typical change in insulation over one day is shown in Figure 4. Sweat collection in footwear is shown in Figures 5 and 6. Some water stayed in sock. The sock dried to start weight over night at room temperature and in the refrigerator. In boot SM, that was conditioned in a box with high humidity, the water from sock did not evaporate totally over night. Each next morning it was about 1-3 g heavier than in

the beginning. The moisture collection in the sock increased with days. SM, when conditioned at low humidity, dried practically to dry weight over the night and insulation reduction over each day was similar. There was no difference in insulation between the days.

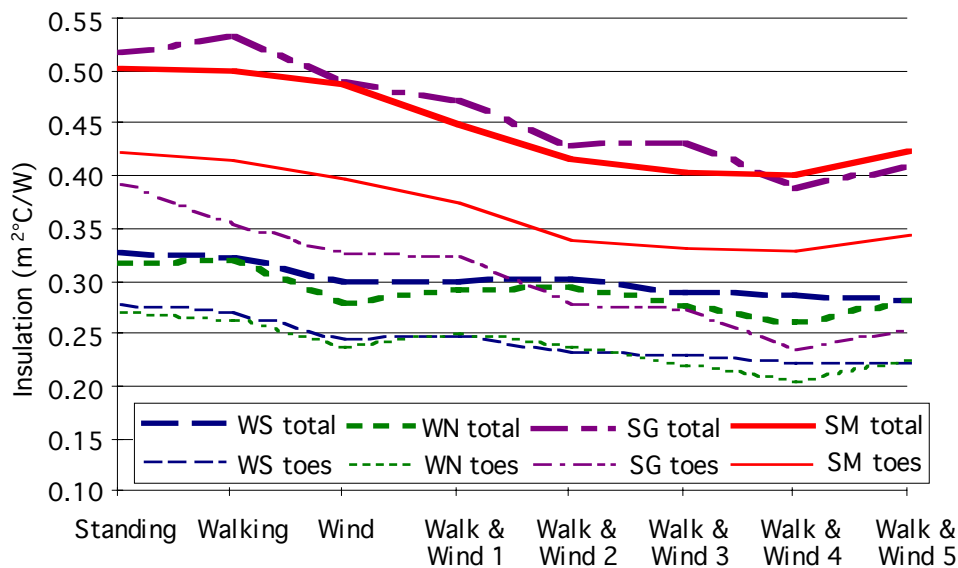

Figure 2. Insulation change. Condition description: Morning Day 1 - first hour of the first measuring day without sweating, wind 1.5 ± 0.5 m/s, up-down motion (8 steps/minute); Evening Day 1 to 5 - last measurement of the day, sweating 5 g/h, wind 1.5 ± 0.5 m/s, up-down motion (8 steps/minute).

In the end of the second day there was observed little frost between shell and inner-boot of SG and between outer and middle layer of SM, but not in SM conditioned at low humidity level. The amount of frost increased with each following day. In the end of the last day there was considerable amount of frost between middle layer and insole, between middle and outer layer and some frost between inner-boot and middle layer of SM. Middle and outer layer had frozen slightly together. After 5 days testing the boot was left at the room temperature and it dried almost to the initial weight within one night. SG dried better in the refrigerator and the amount of frost between layers did not increase as much. However, drying at room temperature to initial weight took longer time for SG than for SM. In a second series with SM at low humidity level the layers except middle layer dried totally out. Even in the middle layer the weight gain was under 10 g over the 5 day period.

The footwear insulation reduced considerably over 5 days period (Figure 3). The biggest reduction occurred during the first hours of the first day, and could be related to the onset of sweating. Similar, but somewhat smaller change was observed in the beginning of each day. During the first, dry measuring hour the results could be affected by the drying of the nearest footwear layers to the foot model, and pressing the moisture border more far from it. General trend was towards lower insulation both in the morning (reduction due to gained moisture left in footwear) and in the evening (reduction due to gained moisture and evaporation in footwear).

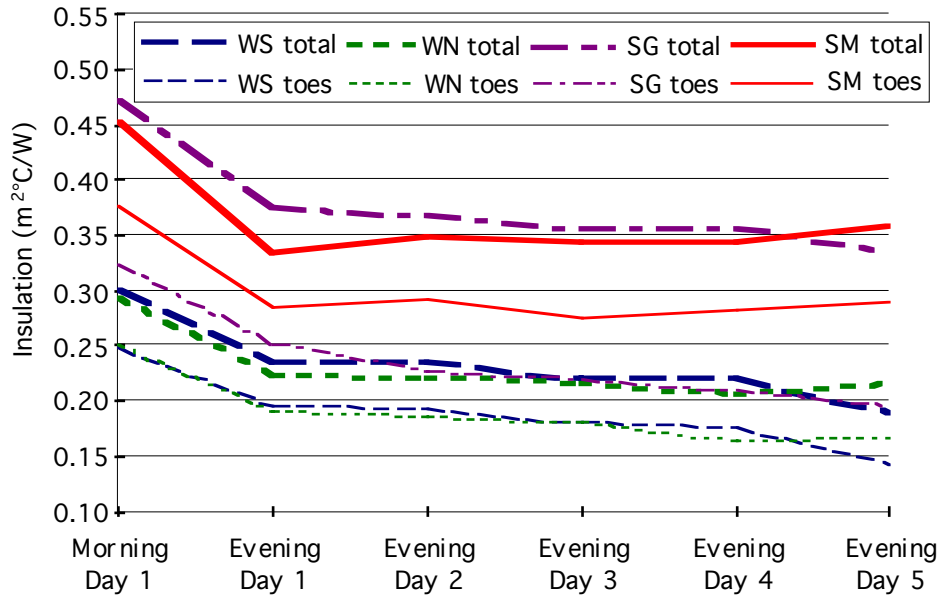

Figure 3. Insulation change. Condition description: Standing - no wind nor sweating; Walking - up-down motion (8 steps/minute), no wind, nor sweating; Wind - air velocity 1.5 ± 0.5 m/s, standing, no sweating; Walk & Wind 1 to 5 - first hour without sweating of each measurement day, wind 1.5 ± 0.5 m/s, up-down motion (8 steps/minute).

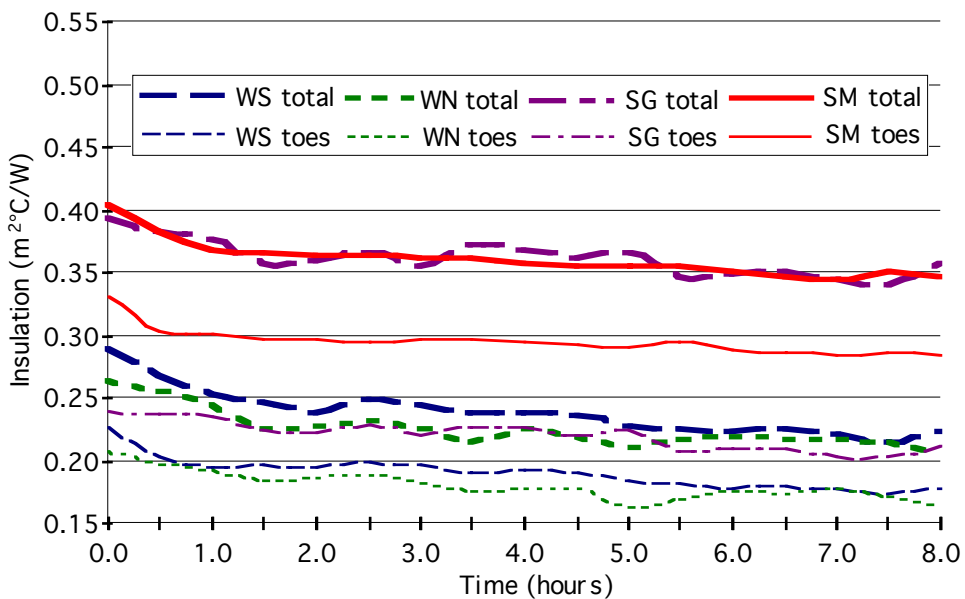

Figure 4. Insulation change over Day 4.

No any specific differences could be observed between footwear with (WS) and without steel toe cap (WN) due to the moisture collection in footwear. Thus the idea of possible differences due to variation in moisture concentration (Kuklane & Holmér 1998) did not find support. The big insulation reduction of boot WS over the last day (Figure 3) could be related to reaching the absorption capacity of the footwear material and not to the influence from the steel toe cap. The explanation to the complaints on the cooling effect of the steel toe cap could be just related to

the after-effect (Kuklane, Geng, & Holmér 1999a), that could depend on higher mass, and thus slower warm up of the steel toe capped feet.

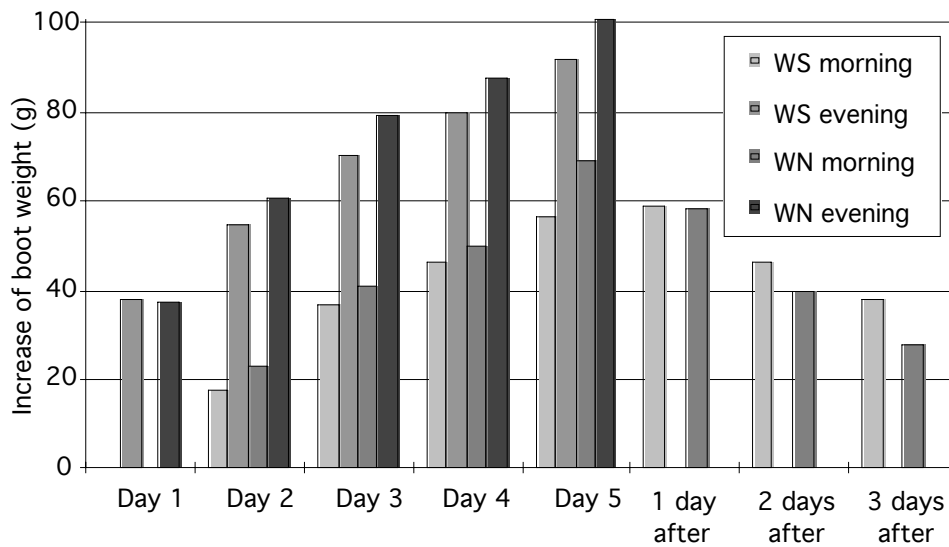

Figure 5. Weight gain in footwear WS and WN over the week.

Within a 5-days military exercise (Martini, 1995) it has been shown that foot-wear can gain totally more than 400 g (per pair) already within first 2 days of exercise even in relatively good weather, and then stayed at about that level. In the present study the boots gained about 100 g of moisture per boot by the end of the last day. The water did not evaporate from the boots WS and WN even at room temperature over night. These footwear dried relatively well around ankle, but the toe area felt soaked during manual examination in the beginning of the tests on last days. This explains also the low insulation values in the toes. The wet insulation layers probably made the sock wet enhancing the heat loss from the toes already in the beginning of the test.

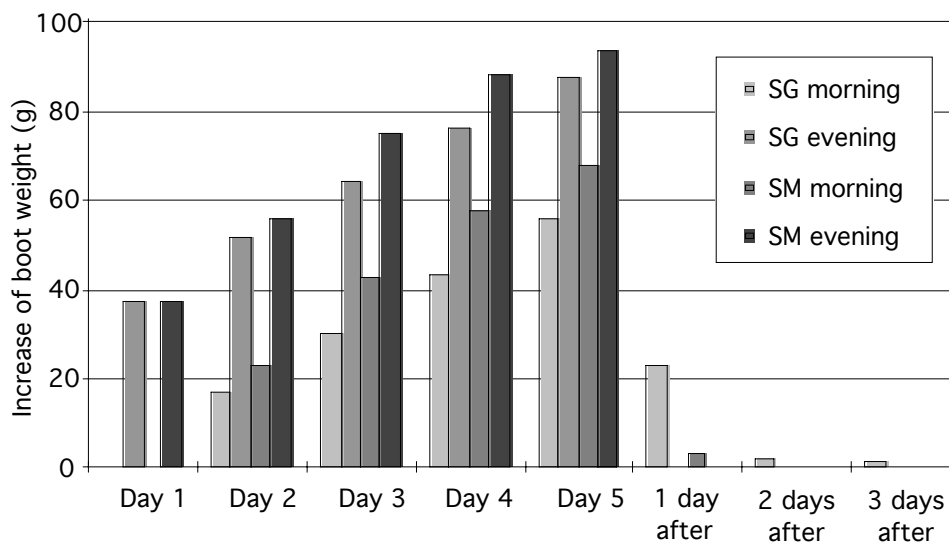

Figure 6. Weight gain in footwear SM and SG over the week.

During the tests there was practically no evaporation from the footwear due to low environmental temperature. Some evaporative heat exchange could be present inside the footwear, i.e. evaporation from the foot surface and condensation in boot layers. As the humidity concentration in footwear was high, the evaporative heat exchange could be driven mostly by temperature gradient. The main heat losses could be related to the increased heat conductivity of the wet footwear insulation.

It can be concluded that the footwear insulation reduces considerably over a week if no measures are taken to dry the footwear between use. The possibility to take out the insulation layers seemed to enhance the drying. It can be recommended to use special footwear dryers or warm air blowers to dry the footwear between work passes. Based on a long test carried out earlier (Kuklane et al. 1999b) the often change of socks can be recommended especially after heavy sweating. If the temperature in the bivouac is under 0 °C and relative humidity is high, the drying of footwear by evaporation can not be expected. The use of absorbing materials inside the footwear at once after doffing them can thus be recommended.

References

- Bergquist K & Holmér I (1997) A method for dynamic measurement of the resistance to dry heat exchange by footwear. *Applied Ergonomics* , 28, (5/6) 383-388
- Burke R A (1998, October 18-23, 1998). *Design and application of a sweating hand system*. Paper presented at the The 8th International Conference on Environmental Ergonomics, San Diego, California, USA
- Giblo J W, Wajda E, Avellini B & Burke R A (1998, October 18-23, 1998). *The next generation sweating thermal manikin test system*. Paper presented at the The 8th International Conference on Environmental Ergonomics, San Diego, California, USA
- Kuklane K, Geng Q & Holmér I (1999a) Thermal effects of steel toe caps in footgear. *International Journal of Industrial Ergonomics* , 23, (5-6) 431-438
- Kuklane K & Holmér I (1997, November 16-20, 1997). *Reduction of footwear insulation due to walking and sweating: a preliminary study*. Paper presented at the International Symposium on Problems with Cold Work, Grand Hôtel Saltsjöbaden, Stockholm, Sweden
- Kuklane K & Holmér I (1998) Effect of sweating on insulation of footwear. *International Journal of Occupational Safety and Ergonomics* , 4, (2) 123-136
- Kuklane K, Holmér I & Giesbrecht G (1999b) Change of footwear insulation at various sweating rates. *Applied Human Science* , accepted,
- Kuklane K, Nilsson H, Holmér I & Liu X (1997, February 12, 1997). *Methods for handwear, footwear and headgear evaluation*. Paper presented at the Proceedings of a European Seminar on Thermal Manikin Testing, Solna, Sweden
- Liu X & Holmér I (1997) Evaluation of evaporative heat transfer characteristics of helmets. *Applied Human Science* , 16, (3) 107-113
- Mahmoud M A (1997) *The effect of wet clothing in heat transfer*. Thesis:M.Sc. Project Report, Luleå University of Technology, Luleå
- Martini S (1995) *The defense in cold: Development of a tent stove and a sleeping bag for the Norwegian Defence Forces (Forsvar i kulde: Utveckling av teltovn og sovepose for*

Forsvaret) (FFI/RAPPORT-95/04239). Kjeller: Norwegian Defence Research Establishment

Meinander H (1992). *Coppelius - a sweating thermal manikin for the assessment of functional clothing*. Paper presented at the Nokobetef IV: Quality and usage of protective clothing, Kittilä, Finland

Santee W R & Endrusick T L (1988) Biophysical evaluation of footwear for cold-weather climates. *Aviat Space Environ Med* , 59, (February) 178-182

Uedelhoven W H & Kurz B (1998, October 18-23, 1998). *Reliable prediction of climatic wearing comfort using improved simulation techniques*. Paper presented at the The 8th International Conference on Environmental Ergonomics, San Diego, California, USA

Weder M (1997, February 12, 1997). *Sweating articulated manikin SAM for thermophysiological assessment of complete garments*. Paper presented at the Proceedings of a European Seminar on Thermal Manikin Testing, Solna, Sweden

Participant list 3IMM 1999

Bernard Redortier, W.L. Gore & Associates. UK
Bård Holand, SINTEF Unimed, Norway
Dan Carlsson, SRV, Sweden
Erhardt Mayer, IBP, Germany
Erik Bjørn, Aalborg University, Denmark
Fredrik Ohlsson, Volvo Car Co, Sweden
Hannu Anttonen, Oulu Reg. Inst., Finland
Harriet Meinander, VTT, Finland
Hayet Sari, Decathlon, France
Henrik Brohus, Aalborg University, Denmark
Håkan Nilsson, NIWL, Sweden
Ingvar Holmér, NIWL, Sweden
Jiang Zhihua, Quartermaster Res. Inst., China
Jonas Rydholm, Taiga AB, Sweden
Kalev Kuklane, NIWL, Sweden
Ken Iwamoto, Panasonic Matsushita Ltd., Japan
Krzysztof Soltynski, Central Inst. of Labour Prot., Poland
Mari Hellsten, VTT, Finland
Maria Konarska, Central Inst. of Labour Prot., Poland
Mats Bohm, SIAE, Sweden
Mike Wilson, SATRA, UK
Mo Hosni, KSU, USA
Morgan Henriksson, Cool Engineering, Sweden
Niklaus Mattle, EMPA, Switzerland
Olle Norén, SIAE, Sweden
Paul Potter, The Coord Goup Ltd, Canada
Peter Holmqvist, Cool Engineering, Sweden
Peter Trans, PT Teknik, Denmark
Peter V. Nielsen, Aalborg University, Denmark
Robert Farrington, National Ren. Energy Lab., USA
Shen Yuhong, Quartermaster Res. Inst., China
Stefan Axelsson, Volvo Truck Co, Sweden
Sven-Erik Hänel, IFP, Sweden
Thomas Lund Madsen, DTU, Denmark
Traugott Zimmerli, EMPA, Switzerland
Victor Candas, CEPA, France
Volkmar Bartels, Hohenstein Inst., Germany
Wolfgang Uedelhoven, Bundeswehr Inst. (WIWEB), Germany
Yang Tingxin, Quartermaster Res. Inst., China
Yutaka Tochihara, Kyushu Inst., Japan