

Androgen receptor signaling mechanisms in bone

Jianyao Wu

Department of Internal Medicine
and Clinical Nutrition,
Institute of Medicine at
Sahlgrenska Academy
University of Gothenburg

Gothenburg, Sweden, 2019



UNIVERSITY OF
GOTHENBURG

Cover illustration by Jianyao Wu.
Micro-CT image of distal femur from an adult male mouse.

Androgen receptor signaling mechanisms in bone
© 2019 Jianyao Wu
jianyao.wu@gu.se

ISBN 978-91-7833-247-2 (PRINT)
ISBN 978-91-7833-248-9 (PDF)
<http://hdl.handle.net/2077/57826>

Printed in Gothenburg, Sweden 2018
Printed by BrandFactory

悠悠漫漫其修远兮

屈原

To my beloved family

Abstract

Osteoporosis is a common age-related disease that increases the risk of fractures. Androgens are crucial for bone health in males. Although a substantial part of the effects of androgens on the skeleton is mediated via conversion of testosterone to estradiol, direct effects of androgens on the androgen receptor (AR) also contribute to male bone homeostasis. The aim of this thesis is to increase the knowledge about the significance of the AR for bone metabolism to potentially identify bone-specific AR signaling pathways.

The thesis is based on studies using several different mouse models with altered AR signaling. In **Paper I**, we demonstrated that inactivation of the AR in immature osteoblast-lineage cells reduces trabecular but not cortical bone mass. Since antiandrogens are frequently used in the treatment of men with prostate cancer, we investigated the possible skeletal side effects of the recently approved antiandrogen drug enzalutamide (**Paper II**). Although this drug effectively reduced the weights of androgen-sensitive reproductive tissues, bone mass was reduced moderately and only in the axial skeleton. To determine the importance of the AR for pubertal and adult bone metabolism, avoiding confounding developmental effects, we inactivated the AR in pre-pubertal as well as in young adult male mice (**Paper III**). We demonstrated that adult AR expression is crucial for trabecular and cortical bone mass maintenance while pubertal AR expression is crucial for normal fat mass homeostasis in adult male mice. The AR activity is regulated by post-translational modifications, including AR SUMOylation. In **Paper IV**, we demonstrated that AR SUMOylation regulates bone mass but not the weights of androgen-responsive reproductive tissues, suggesting that therapies targeting AR SUMOylation might result in bone-specific anabolic effects with minimal adverse effects in other tissues.

The findings in this thesis contribute with important knowledge for the development of new treatment options for men with osteoporosis and safer endocrine treatments, with minimal skeletal side effects, for men with prostate cancer.

Keywords: Androgen receptor, bone, osteoporosis, mouse

Sammanfattning på svenska

Osteoporos, benskörhet, är en åldersrelaterad folksjukdom som ökar risken för frakturer. Mäns skelett regleras av kroppens androgener där en väsentlig del av effekterna på skelettet sker via omvandling av testosteron till östradiol. Skelettet påverkas även av att androgener aktiverar androgenreceptorer (AR). Syftet med denna avhandling har varit att öka kunskapen kring ARs betydelse för benmetabolismen i relation till andra androgenkänsliga organ för att på sikt kunna identifiera skelettspecifika signaleringsvägar via AR.

Avhandlingen baseras på experiment med musmodeller som på olika sätt har förändrad möjlighet att signalera via AR. I **delarbete I** studerade vi skelettet hos möss vars alla celler som härstammar från omogna osteoblastceller saknar uttryck av AR. Resultaten visade att signalering via AR i osteoblaster är av betydelse för det trabekulära men inte för det kortikala benet. Eftersom män som drabbats av prostatacancer ofta behandlas med antiandrogener, undersökte vi i **delarbete II** hur ett nyligen godkänt antiandrogenläkemedel, enzalutamid, påverkar skelettet hos möss. Studien visade att behandling medförde en minskning av benmassan i det axiala men inte i det appendikulära skelettet. Genom en inducerbar knockoutmodell studerade vi därefter i **delarbete III** hur det vuxna djurets skelett påverkas då AR inaktiverats strax innan respektive direkt efter puberteten. Resultaten klargjorde att en bibehållen funktionell AR är nödvändig för att upprätthålla benmassan hos vuxna hanmöss. Aktiviteten av AR regleras av post-translationala modifieringar såsom SUMOylering. I **delarbete IV** undersökte vi betydelsen av SUMOylering av AR. Resultaten visade att möjlighet till SUMOylering av AR är nödvändig för reglering av benmassan medan andra androgenkänsliga reproduktiva organ inte påverkades. Läkemedel som riktar sig mot SUMOyleringsförmågan av AR kan därmed troligtvis resultera i benspecifika anabola effekter med minimala biverkningar i andra organ.

Resultaten från denna avhandling tillför värdefull kunskap till utvecklingen av nya behandlingsalternativ för patienter med osteoporos samt bidrar med information kring säkrare behandlingar, med minimala skelettbiverkningar, för män med prostatacancer.

List of papers

This thesis is based on the following studies, referred to in the text by their Roman numerals.

- I. Wilhelmson AS, Stubelius A, Börjesson AE, **Wu J**, Stern A, Malin S, Mårtensson IL, Ohlsson C, Carlsten H, Tivesten Å.
Androgens Regulate Bone Marrow B Lymphopoiesis in Male Mice by Targeting Osteoblast-Lineage Cells
Endocrinology 2015; 156(4): 1228–36

- II. **Wu J**^{*}, Movérare-Skrtic S^{*}, Börjesson AE, Lagerquist MK, Sjögren K, Windahl SH, Koskela A, Grahnemo L, Islander U, Wilhelmson AS, Tivesten Å, Tuukkanen J, Ohlsson C.
Enzalutamide Reduces the Bone Mass in the Axial But Not the Appendicular Skeleton in Male Mice
Endocrinology 2016; 157(2): 969–77

- III. **Wu J**, Henning P, Sjögren K, Koskela A, Tuukkanen J, Movérare-Skrtic S^{*}, Ohlsson C^{*}.
The Androgen Receptor is Required for Maintenance of Bone Mass in Adult Male Mice
Molecular and Cellular Endocrinology 2019; 479: 159–169

- IV. **Wu J**, Movérare-Skrtic S, Zhang FP, Koskela A, Tuukkanen J, Palvimo JJ, Sipilä P, Poutanen M^{*}, Ohlsson C^{*}.
Androgen Receptor SUMOylation Regulates Bone Mass in Male Mice
Molecular and Cellular Endocrinology 2019; 479: 117–122

*Contributed equally

Article reprints were used with permission from the publishers.

Contents

Abbreviations	XII
1. Introduction.....	1
1.1 Skeletal physiology	1
1.2 Bone cells	2
1.3 Bone modeling and remodeling.....	4
1.4 Osteoporosis.....	6
1.5 Male osteoporosis.....	6
1.6 Fracture risk assessment.....	7
1.7 Androgens.....	7
1.8 Androgen receptor (AR).....	8
1.9 SUMOylation of the AR.....	9
1.10 Androgens and bone.....	10
1.11 Androgens and bone - animal models.....	11
1.12 Prostate cancer.....	12
1.13 Androgen deprivation therapy (ADT) and AR antagonists.....	12
1.14 Selective androgen receptor modulators (SARMs).....	14
2. Aims.....	15
3. Methodological considerations	17
3.1 Animal models.....	17
3.1.1. Cre-loxP recombination system.....	18
3.1.2. The AR ^{SUM} - mouse model.....	19
3.2 Dual-energy X-ray absorptiometry (DXA).....	20
3.3 Micro-computed tomography (μ CT).....	20
3.4 Biomechanical testing.....	21
3.5 Histomorphometric analyses.....	22

3.6 Serum measurements.....	22
3.7 DNA and RNA quantification.....	23
3.8 Western blot.....	24
4. Results.....	25
4.1 Paper I.....	25
4.2 Paper II.....	26
4.3 Paper III.....	27
4.4 Paper IV.....	28
5. Discussion.....	29
5.1 AR expression in immature osteoprogenitor cells affects trabecular but not cortical bone.....	29
5.2 Effects of enzalutamide on bone.....	31
5.3 Presence of a functional AR in adult mice is required to maintain trabecular and cortical bone mass.....	33
5.4 Role of post-translational modification of the AR in bone.....	35
6. Conclusions.....	37
7. Future perspective	39
Related publications not included in the thesis	41
Acknowledgments.....	43
References.....	45

Abbreviations

aBMD	Areal bone mineral density
ADT	Androgen deprivation therapy
AF-1	Activation function-1
AF-2	Activation function-2
ALP	Alkaline phosphatase
AR	Androgen receptor
Arginine	R
B.Ar	Total bone area
BMD	Bone mineral density
BMPs	Bone morphogenetic proteins
BMU	Basic multicellular unit
BV/TV	Bone volume/total volume
Cbfa1	Core-binding factor alpha 1
CCD	Charge-coupled detector
cDNA	Complimentary DNA
Coll α 1	Collagen 1 α 1
CRPC	Castration-resistant prostate cancer
Ct.Ar	Cortical bone area
Ct.Po	Cortical porosity
Ct.Th	Cortical thickness
CTX	C-terminal telopeptide
CYP19A1	Cytochrome P450 family 19 subfamily A member 1
DBD	DNA binding domain
DHEA	Dehydroepiandrosterone
DHEA-S	Dehydroepiandrosterone sulfate
DHT	Dihydrotestosterone
DMP1	Dentin matrix acidic phosphoprotein 1
DNA	Deoxyribonucleic acid
DXA	Dual-energy X-ray absorptiometry
E1	Estrone
E2	17 β -Estradiol
EGF	Epidermal growth factor
ELISA	Enzyme-linked immunosorbent assay
EMA	European Medicines Agency
ER	Estrogen receptor
FDA	Food and Drug Administration

FSH	Follicle-stimulating hormone
GADPH	Glyceraldehyde-3-phosphate dehydrogenase
GC-MS/MS	Gas chromatography-tandem mass spectrometry
GnRH	Gonadotropin-releasing hormone
H	Hinge region
IGF-1	Insulin-like growth factor 1
IL	Interleukin
K	Lysine
KO	Knockout
LBD	Ligand binding domain
LH	Luteinizing hormone
Ma.Ar	Marrow cavity area
M-CSF	Macrophage colony-stimulating factor
mRNA	Messenger RNA
MSCs	Mesenchymal stem cells
MyoD	Myoblast determination protein
NFATc1	Nuclear factor of activated T-cells, cytoplasmic 1
NF- κ B	Nuclear factor kappa B
nmCRPC	Non-metastatic castration-resistant prostate cancer
NTD	N-terminal transactivation domain
Ocn	Osteocalcin
OPG	Osteoprotegerin
Orx	Orchiectomy
Osx	Osterix
PC	Prostate cancer
PCR	Polymerase chain reaction
PPAR γ	Peroxisome proliferator-activated receptor gamma
pQCT	Peripheral quantitative computerized tomography
Prx1	Paired related homeobox 1
PTHrP	Parathyroid hormone-related protein
PTMs	Post-translational modifications
RANKL	Receptor activator of nuclear factor kappa-B ligand
Runx2	Runt-related transcriptional factor 2
SARMs	Selective androgen receptor modulators
SENPs	Sentrin/SUMO-specific proteases
SERMs	Selective estrogen receptor modulators
SHBG	Sex hormone-binding globulin
Sox9	Sex determine region Y-box 9
Sp7	Specificity protein transcription factors 7
Srd5 α 1/2	5 α -reductase enzymes
SUMO	Small ubiquitin-related modifier

T	Testosterone
Tb.N	Trabecular number
Tb.Sp	Trabecular separation
Tb.Th	Trabecular thickness
Tfm	Testicular feminization
TRAP	Tartrate-resistant acid phosphatase
UV	Ultraviolet
vBMD	Volumetric bone mineral density
WHO	World Health Organization
WT	Wild type
μ CT	Micro-computed tomography
3D	Three-dimensional

1. Introduction

Osteoporosis is a common age-related disease that increases the risk of bone fractures, not only in women but also in men. Androgens, such as testosterone (T), have been identified as key determinants for male bone health. However, treatment with androgens may lead to side effects such as increased risk of cardiovascular diseases and increased risk of prostate cancer due to a stimulation of the prostate. Therefore, increased knowledge about the signaling mechanisms of androgens via the androgen receptor (AR) is needed for the development of new bone-specific selective androgen receptor modulators (SARMs) with minimal systemic side effects. There is also a need for more knowledge about the possible skeletal side effects of newly developed drugs for prostate cancer.

1.1 Skeletal physiology

The skeleton is a vital organ for vertebrates and it is made of bone cells and extracellular mineralized matrix. The adult human skeleton is composed of 206 bones and is usually categorized as the axial skeleton, including the skull, rib cage and vertebral column, and the appendicular skeleton, including the upper and lower limbs, shoulders, and pelvis.

The skeleton consists of two different types of bone, the cortical and trabecular (cancellous) bone. Cortical bone forms the compact outer shell of the bone, and contributes to 80% of the weight of the human skeleton^(1,2). It supports the whole body, provides localization for muscle and nerve growth, protects pivotal organs, such as brain and heart, and stores and releases chemical elements, mainly calcium and phosphate. Trabecular bone is located within the bones and has higher bone surface area per volume than cortical bone, which is suitable for metabolic activity, e.g. exchange of calcium ions. Trabecular bone is typically found within the ends of the long bones and accounts for more than 70% of the interior of vertebrae^(3,4).

The long bones have three distinct parts: epiphysis, metaphysis and diaphysis (Figure 1). The epiphysis is the wider section at each end of the long bone and it is composed of cortical bone on the outside and trabecular bone on the inside. The midsection shaft of the long bone is called diaphysis and is composed of cortical bone surrounding a central marrow cavity containing bone marrow and fat. The metaphysis, located between the epiphysis and diaphysis, contains the growth plate.

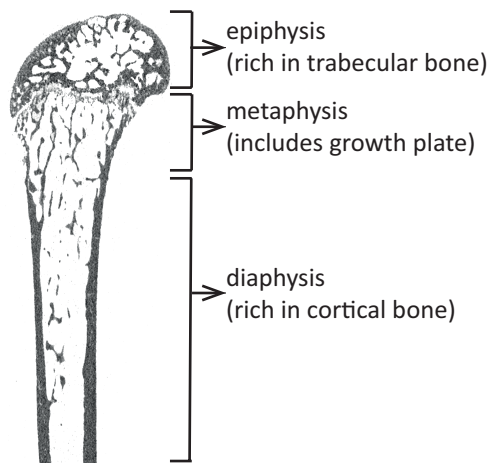

Figure 1 Longitudinal μ CT scan image of distal femur from an adult male mouse. Scanned by Jianyao Wu.

1.2 Bone cells

Osteoblasts are derived from mesenchymal stem cells (MSCs) and are responsible for the generation of new bone matrix. MSCs can be isolated from bone marrow and most connective tissues^(5,6). MSCs are capable of differentiating into diverse cell lineages (adipocytes, chondrocytes, myoblasts, fibroblasts, and osteoblasts) in a process controlled by various cytokines, growth factors, and transcription factors (Figure 2). For instance, PPAR γ is a key transcription factor for the differentiation of MSCs into adipocytes while Sox9 and MyoD are key transcription factors for the differentiation of MSCs into chondrocytes and myoblasts, respectively⁽⁷⁾. The osteoblast differentiation occurs through a multi-step molecular pathway regulated by different transcription factors and signaling proteins including Wnts, Notch and bone morphogenetic proteins (BMPs)^(8,9). Runx2 (also known as Cbfa1) is a transcription factor necessary for the progress of MSCs into osteoprogenitor cells whereas Osx1 (also known as Sp7) is required for the differentiation of pre-osteoblasts into mature osteoblasts. Mature osteoblasts express alkaline phosphatase (ALP) osteocalcin (OCN) and collagen 1 α 1 (Col1 α 1). Mature osteoblasts can further differentiate into bone-lining

cells or mechano-sensing osteocytes, which are embedded in the matrix and express DMP1 and sclerostin^(8,9).

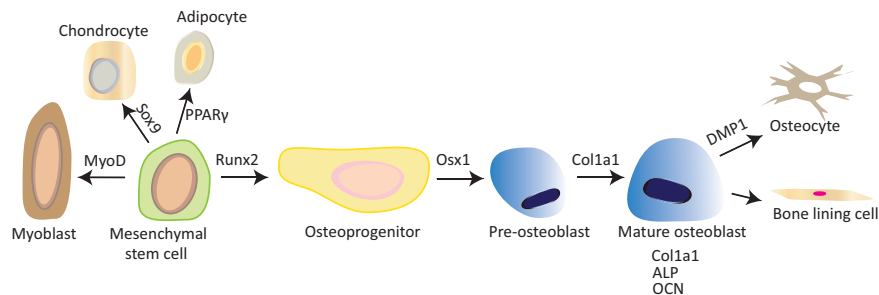

Figure 2 Osteoblast differentiation. Adapted from “Molecular mechanisms of mesenchymal stem cell differentiation towards osteoblasts” by Fakhry M et al, 2013, World Journal of Stem Cells, p136-148. CC BY-NC 4.0.

Osteoclasts are specialized bone resorbing multinuclear cells, derived from hematopoietic precursors and distributed on the bone surface^(10,11). Initially, bone marrow macrophages differentiate into tartrate-resistant acid phosphatase (TRAP)-positive preosteoclasts (Figure 3). The preosteoclasts fuse with each other to form multinucleated osteoclasts. Generation of osteoclasts require binding of two ligands: the macrophage colony-stimulating factor (M-CSF) to its receptor c-Fms and RANKL (the receptor activator of nuclear factor kappa B (NF- κ B) ligand), also known as TNFSF11, to its receptor RANK^(12,13). The RANKL-stimulated osteoclastogenesis is inhibited by the RANKL decoy receptor osteoprotegerin (OPG) expressed by osteoblast lineage cells. Furthermore, cytokines such as IL-1 and TNF- α also regulate osteoclastogenesis. The master transcription factor for osteoclast differentiation and function is NFATc1 (nuclear factor of activated T-cells, cytoplasmic 1) whereas the degradation of the organic component of bone matrix is accomplished by different enzymes including the lysosomal proteolytic enzyme cathepsin K.

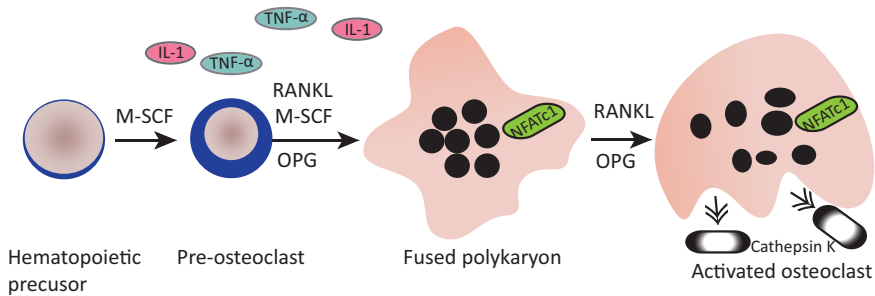

Figure 3 Osteoclast differentiation. Adapted from “Osteoclast differentiation and activation” by Boyle WJ, Simonet WS, and Lacey DL, 2003, *Nature*, p337-342. Reprint with permission from the publisher.

1.3 Bone modeling and remodeling

There are two modes of bone formation in mammals – endochondral and intramembranous ossification, both involving transformation of mesenchymal tissue or cartilage into bone tissue⁽¹⁴⁾. The main growth and development of the skeleton occurs until the end of sexual maturation⁽¹⁵⁾. This period is referred to as modeling phase. During the modeling phase, the activities of the osteoblasts and osteoclasts are mainly uncoupled and the bone formation rate exceeds bone resorption leading to a net increase in bone mass. In addition to this accrual of bone mass, substantial changes in the gross morphology of the bone can be observed. The morphologic changes include longitudinal growth of the long bones, which is achieved by bone formation at the epiphyseal growth plates, and radial growth due to bone formation on the outer surface of the cortex (periosteal apposition) and resorption on the inner surface (endosteal resorption). The epiphyseal growth plates gradually close in humans at the end of puberty and longitudinal growth is thereby completed^(16,17).

The size of the bones differs between the genders^(18,19). Men are on average 10% taller and have larger bone width than women. This observation is considered to be mainly due to the greater periosteal expansion during puberty and early adulthood in boys, whereas girls predominantly increase their cortical thickness by limiting endocortical expansion^(20,21).

Bone is an extremely dynamic organ. During lifetime, old bone tissue with micro-damages is continuously replaced by newly formed bone tissue so that it constantly adapts to mechanical load and strain⁽²²⁾. This process is called bone remodeling⁽²³⁾. Bone remodeling takes place in what Frost termed the basic multicellular unit (BMU), which comprises the osteoclasts, osteoblasts, and osteocytes within the bone-remodeling cavity (Figure 4). The remodeling cycle consists of four consecutive phases: activation, resorption, reversal, and formation⁽²⁴⁾. The remodeling begins with the migration of partially differentiated mononuclear preosteoclasts to the bone surface where they get activated and form large multinucleated osteoclasts. The osteoclasts bind to the bone surface with adhesive proteins, creating a closed microenvironment where acidic hydrogen ions and proteolytic enzymes are secreted to resorb bone tissue. After the completion of osteoclastic bone resorption, there is a reversal phase when mononuclear cells appear on the bone surface. These cells prepare the surface for new osteoblasts to begin bone formation and provide signals for osteoblast differentiation and migration. The formation phase follows with osteoblasts laying down bone until the resorbed bone is completely replaced by new. When this phase is complete, the surface is covered with flattened lining cells and a prolonged resting period begins until a new remodeling cycle is initiated.

In humans, the rate of bone remodeling is 5-10% per year; hence most of the skeleton will be replaced within 10 years⁽²⁵⁾. During normal bone remodeling, the resorbed bone is completely replaced by new bone. This is secured through tight coupling of bone resorption to bone formation⁽²⁶⁾. Although the mechanisms underlying the coupling process still remain largely unknown, the process is modulated by a wide variety of hormones and locally generated cytokines secreted in response to mechanical stimulation and microdamage⁽²⁶⁾.

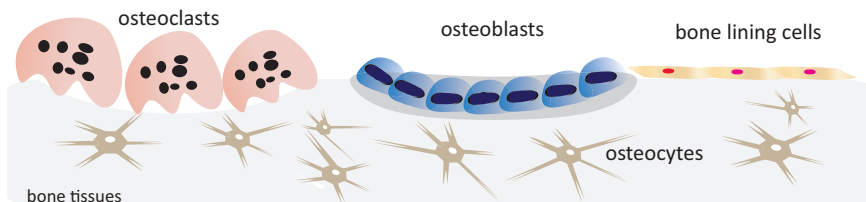

Figure 4 Bone cells in remodeling process. Adapted from "Bone-tissue engineering: complex tunable structural and biological responses to injury, drug delivery, and cell-based therapies" by Alghazali KM et al, 2015, Drug Metabolism Reviews, p431-454. Reprint with permission from the publisher.

1.4 Osteoporosis

Osteoporosis is a systemic metabolic bone disease which is characterized by low bone mass and deterioration of bone microstructure, leading to enhanced bone fragility and increased fracture risk. Osteoporosis-related fractures, especially hip fractures, constitute major health concerns worldwide in terms of both human suffering and financial cost. The lifetime risk at age 50 of having a fragility fracture is about 20% for men and 50% for women in Sweden⁽²⁷⁾. In 1994, the World Health Organization (WHO) established the criteria for osteoporosis diagnosis in women⁽²⁸⁾ and it is defined as an areal bone mineral density (aBMD) of either the hip or spine below -2.5 standard deviations (SD) of the mean in young adult women (T-score)⁽²⁸⁾. There is no absolute diagnostic criteria established for men, although the common practice is to use the same criteria as for women with a young male population as reference.

In secondary osteoporosis, the bone loss is not due to aging or postmenopausal status but instead caused by other diseases including inflammatory or endocrine disorders, cancers, or medical therapies⁽²⁹⁻³¹⁾. Cancer-associated bone loss can result from the primary disease itself, either due to circulating bone resorbing substances or metastatic bone disease, or from the therapies administered to treat the primary condition⁽³²⁾. In the former case, generalized bone loss is caused by circulating bone resorbing hormones or cytokines, such as parathyroid hormone-related protein (PTHrP), RANKL, IL-6 or IL-3, produced by the tumor or local effects of the metastatic deposit⁽³³⁻³⁵⁾. In the latter case, bone loss is due to therapies such as chemotherapeutics, corticosteroids, aromatase inhibitors or androgen deprivation therapy (ADT)⁽³⁵⁾. Estrogen deprivation therapy in women with breast cancer and ADT in men with prostate cancer accelerate bone turnover leading to a decrease in BMD and an increased fracture incidence⁽³⁶⁾.

1.5 Male osteoporosis

Osteoporosis is not as common in men as in women, but with the aging of the population, osteoporosis in men is becoming an increasingly important public health problem. Recent studies have demonstrated that in men, just like in women, trabecular bone loss begins in young adult life, whereas cortical bone loss begins after midlife^(21,37). Hip fractures con-

tribute to the greatest morbidity and mortality among all osteoporotic fractures, and the severe consequences of hip fractures are more pronounced in men compared with women⁽²⁷⁾. However, the proportion of men with fractures treated with osteoporosis drugs is lower than the proportion of women treated⁽³⁸⁾. Importantly, higher mortality after low-trauma fracture has been demonstrated in men when compared with women⁽³⁹⁾.

1.6 Fracture risk assessment

Although low BMD is a major risk factor for osteoporotic fractures, several other important risk factors such as gender, age, previous osteoporotic fracture, family history of hip fractures, and systemic glucocorticoid treatment have been described^(40,41). In addition, low body weight, smoking, high alcohol consumption, insufficient vitamin D intake, hypogonadism, early menopause in women, inactivity and risk factors for falling have been described to associate with increased risk of fractures. In order to take several identified risk factors into account for fracture risk assessment, the web-based fracture risk assessment tool FRAX[®] was introduced⁽⁴²⁾. It uses an algorithm to compute the 10-year probability of hip fracture and/or major osteoporotic fracture in individuals by integrating several important individual clinical risk factors for fracture, with or without the addition of femoral neck BMD. The risk is calculated in a population-specific manner, where the absolute fracture risk varies according to the selected country (<https://www.sheffield.ac.uk/FRAX/>).

1.7 Androgens

Sex steroids include androgens, such as T and dihydrotestosterone (DHT), and estrogens, such as 17 β -estradiol (E2) and estrone (E1), and are predominately produced by the testes in men and ovaries in women. In addition to the gonadal sex steroids, the human adrenal cortex produces substantial amounts of the sex steroid precursors dehydroepiandrosterone (DHEA) and dehydroepiandrosterone sulfate (DHEA-S), which can be locally converted into androgens and estrogens in both males and females. In contrast to humans and higher primates, the adrenal gland of adult rodents (e.g. rats and mice) produce little or no DHEA⁽⁴³⁾, but their

adrenals produce substantial amounts of the androgen precursor androstenedione⁽⁴⁴⁾. Androgens are crucial for the development of male reproductive tissues such as the testis and prostate. In addition, they exert several other important effects on muscle mass, bone mass and fat distribution.

The production of T is regulated by the hypothalamic-pituitary-gonadal axis^(45,46). Gonadotropin-releasing hormone (GnRH) from the hypothalamus stimulates pituitary release of luteinizing hormone (LH) that stimulates the production of T in the Leydig cells in the testes. In peripheral tissues, T can be converted by 5 α -reductase enzymes (Srd5a1 and Srd5a2) into the more potent androgen DHT^(47,48). T can also be converted into E2 by the aromatase (CYP19A1) enzyme (Figure 5). In the human circulation, ~98% of the T is bound to albumin or sex hormone-binding globulin (SHBG) with only a small fraction being free (~2%)⁽⁴⁹⁾.

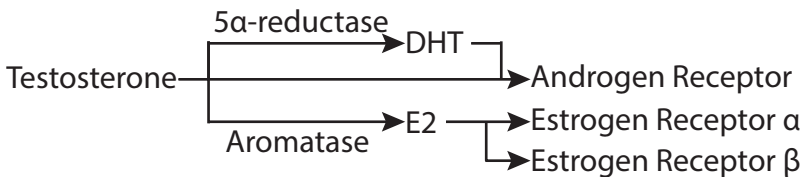

Figure 5 The androgen receptor (AR) and estrogen receptors (ER) α and β can be activated directly or indirectly by testosterone.

1.8 Androgen receptor (AR)

Androgens mediate their effects mainly through the AR that is a DNA-binding transcription factor^(50,51). The AR is found in many different types of cells in tissues such as testes, prostate, breast, uterus, muscles and skeleton⁽⁵²⁻⁵⁴⁾. In the absence of androgens, the AR is localized to the cytoplasm. Upon addition of androgens, the AR is translocated to the nucleus where the liganded-AR transactivates downstream genes. The AR gene is located on chromosome Xq11-12 and is encoded by eight exons^(55,56). It consists of four unique domains: the N-terminal transactivation domain (NTD), the DNA-binding domain (DBD), the hinge region (H), and the ligand binding domain (LBD)⁽⁵⁷⁾. The NTD is fully encoded by exon 1 and it contains the activation function-1 (AF-1), which is crucial for the AR's transcriptional activities^(58,59). The DBD encoded by exons 2 and 3, is critical for the specific binding of the AR to

androgen responsive elements and the stabilization of DNA-receptor interactions^(60,61). The 5' region of exon 4 encodes the hinge region that contains the nuclear localization signal^(62,63). The 3' region of exon 4 and exons 5–8 encode the LBD that contains activation function-2 (AF-2), which is important for the ligand-dependent activation of the receptor (Figure 6)^(64,65).

Although activation of the AR is highly dependent on a ligand, ligand-independent activation of the AR is also possible. Ligand-independent mechanisms of AR activation and altered AR transcriptional activity include AR activation by growth factors such as IGF-1 and EGF⁽⁶⁶⁾, the receptor tyrosine kinase-activated pathway (HER-2/neu signaling cascade; Src kinase)⁽⁶⁷⁻⁶⁹⁾, and the AKT pathway⁽⁷⁰⁾.

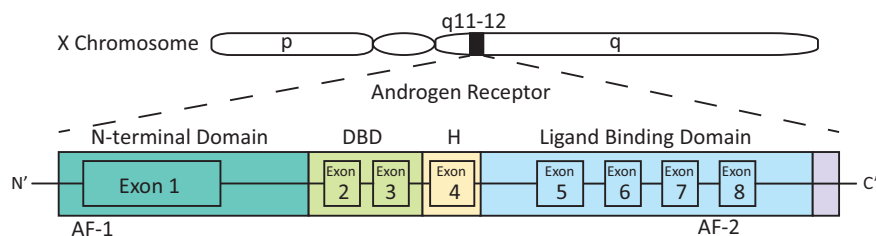

Figure 6. Androgen receptor domains. Adapted from “https://commons.wikimedia.org/wiki/File:Functional_domains_of_the_human_androgen_receptor.svg” by Wikimedia Commons. CC BY-SA 3.0.

1.9 SUMOylation of the AR

The AR activity is regulated by several different post-translational modifications (PTMs), including phosphorylation, acetylation, SUMOylation, ubiquitination and methylation⁽⁷¹⁾. The importance of PTMs of the AR for male bone metabolism is unknown. SUMOylation is a reversible modification in which small ubiquitin-related modifier (SUMO) proteins are covalently attached to specific lysine residues, thereby regulating diverse cellular processes, including transcription, replication, chromosome segregation, and DNA repair^(72,73). Substrate modification by SUMOylation can alter protein-protein interactions, change the intracellular localization of the protein, or directly change the activity of the protein to which SUMO is attached⁽⁷¹⁾. There are three members of the SUMO protein family that can be conjugated to proteins: SUMO1, SUMO2 and SUMO3. SUMO2 and SUMO3 differ by only

three N-terminal residues and are often referred to collectively as SUMO2/3. In contrast, SUMO1 shares only 50% similarity with SUMO2/3⁽⁷³⁾. AR SUMOylation is a reversible process achieved by SUMO proteases termed Sentrin/SUMO-specific proteases (SENPs)⁽⁷⁴⁾.

In humans, AR SUMOylation occurs within the N-terminal domain of AR at Lys386 (Lys381 in mouse) and Lys520 (Lys500 in mouse). *In vitro* experiments have established that reversible SUMOylation is a mechanism for regulation of AR function⁽⁷⁴⁾. The initial *in vitro* studies indicated that AR SUMOylation mainly reduced AR activity, while a subsequent more detailed functional *in vitro* study revealed that AR SUMOylation also may lead to increased AR-dependent transcription⁽⁷⁴⁻⁷⁶⁾. In the later study, the role of the two AR SUMOylation sites was evaluated by comparing cell lines expressing WT AR with cell lines expressing doubly SUMOylation site-mutated AR⁽⁷⁶⁾. Genome-wide gene expression analyses of these cell lines revealed that AR SUMOylation modulates the AR function in a target gene and pathway selective manner. Besides, SUMOylation mutant AR cells proliferated faster than WT cells. These data indicate that AR SUMOylation does not simply suppress the AR activity, but regulates the AR's interaction with the chromatin and the receptor's target gene selection. In addition, this might occur in a promoter specific and cell-type specific context⁽⁷⁶⁾. Further analysis of SUMOylation of AR should provide a better understanding of AR function in normal and diseases states and may lead to the discovery of novel therapeutic options.

1.10 Androgens and bone

Both androgens and estrogens are important for bone health in men. Men with inactive ER α or aromatase deficiency do not display any growth plate closure, demonstrating that estrogens have a dominant role in this process⁽⁷⁷⁻⁸¹⁾. Most of the effects of T on longitudinal bone growth are believed to be mediated via estrogens.

During and shortly after puberty, boys develop wider bones due to greater periosteal bone apposition whereas the cortical endosteal perimeter is reduced in girls^(20,21). The cortical bone in men is thereby placed further outward compared with women and this results in stronger bones in men than in women. The periosteal expansion is known to be

stimulated by androgens and inhibited by estrogens. An effect of androgens on periosteal bone expansion is supported by the observation that serum levels of free T were positively associated with the periosteal circumference at both the tibia and the radius in young men⁽⁸²⁾.

Hypogonadal men with low T have low bone mass and increased risk of osteoporosis and fractures^(83,84). Observational studies demonstrate that serum E2 and especially bioavailable E2 correlate better with BMD at various bone sites than serum T does in men⁽⁸⁵⁻⁸⁷⁾. Furthermore, analyses of well-powered cohorts of elderly men with serum sex steroids analyzed by mass spectrometry demonstrate that serum E2 was inversely associated with the risk of fracture⁽⁸⁸⁾. In the MrOS Sweden cohort, low E2 but not low T was an independent predictor of fracture risk. The relation between bioavailable E2 and fracture risk was nonlinear and the fracture risk was clearly elevated below a specific E2 threshold (~12-16 pg/ml)^(88,89). In some prospective studies, low serum levels of T have been associated with a modest increase in fracture risk⁽⁹⁰⁻⁹²⁾. This association has been proposed to be mediated via effects of T on muscle mass⁽⁹³⁾ and risk of falls⁽⁹⁰⁾.

1.11 Androgens and bone - animal models

Rodent models have been very important to investigate the cellular and molecular mechanisms of sex steroid actions in bone. However, some differences between rodents and humans need to be considered⁽⁹⁴⁾. Although rodents produce the androgen precursor androstenedione, they do not produce significant amount of DHEA in the adrenal glands⁽⁴⁴⁾. Furthermore, rodents do not express SHBG and the circulating levels of sex steroids are much lower in rodents compared with humans. Therefore sensitive and specific assays for serum sex steroid analyses in rodents are required⁽⁹⁵⁾. Alternatively, the weights of sex steroid sensitive reproductive tissues can be used as biomarkers of sex steroid status in rodents. In addition, the growth plates do not close directly after sexual maturation in rodent models.

The effects of sex steroids on the skeleton have been widely studied in rodents by gonadectomy followed by hormone replacement therapy, and by administration of AR antagonists, ER antagonists, aromatase inhibitors, SARMs, selective estrogen receptor modulators (SERMs) and

type II 5 α -reductase inhibitors. In male rodents, orchidectomy increases bone turnover and bone resorption is increased more than bone formation, resulting in trabecular and cortical bone loss⁽⁹⁶⁻⁹⁸⁾.

The importance of sex steroid receptors has further been studied using different mouse models. Male testicular feminization (Tfm) mice have a non-functional AR and a high bone turnover phenotype⁽⁹⁹⁾. Furthermore, several ubiquitous male ARKO mouse models have been developed and they all exhibit low bone mass and high bone turnover, which is consistent with the effects of androgen deficiency⁽¹⁰⁰⁻¹⁰⁵⁾. Cell-specific ARKO mice models have revealed that AR signaling in osteoblasts is responsible for the protective effects of androgens on trabecular bone mass whereas the target cell(s) for the effects of AR on cortical bone mass remain unknown^(101,106-108). Although all these different ARKO mouse models have been informative, they all lack AR expression since the time of conception and it is therefore not possible to determine if the observed effects are developmental or not. Furthermore, the primary target cell for the effects of androgens on cortical bone mass remains to be identified.

1.12 Prostate cancer

Prostate cancer (PC) is the most common type of cancer for men in Sweden. Localized PC may be treated with surgery (radical prostatectomy) or radiation therapy. The role of androgens for PC was first demonstrated in 1941 by Huggins, who showed that surgical castration, removing testicle-derived androgens, reduced tumor size and tumor symptoms⁽¹⁰⁹⁾. Since then, surgical or chemical ADT is the first treatment of metastatic PC. Unsurprisingly, ADT is associated with bone loss and increased risk of bone fractures^(94,110).

1.13 Androgen deprivation therapy (ADT) and AR antagonists

ADT, using surgical or chemical castration, is a standard treatment for metastatic PC. The goal of the treatment is to reduce the levels of androgens in the body and thereby block the growth of prostate cancer cells. Chemical castration i.e. gonadotropin-releasing hormone (GnRH)

agonists or antagonists, targets the hypothalamic-pituitary-gonadal axis⁽¹¹¹⁾. Administration of GnRH agonists results in downregulation of the pituitary receptors for GnRH, leading to suppression of FSH and LH and thereby the testicular production of T is suppressed⁽¹¹²⁾. GnRH agonists have become the standard first-line hormonal treatment in patients with metastatic PC⁽¹¹²⁾. Beside the testes, the adrenal gland and prostate cancer cells may also synthesis androgens or androgen precursors. This non-testicular androgen synthesis, not affected by ADT, can be inhibited by use of CYP17 α hydroxylase inhibitors such as abiraterone acetate that inhibits a key step in the synthesis of androgens^(113,114). The conversion of DHT from T can be inhibited by 5 α reductase inhibitors (such as finasteride), but this treatment is only used to shrink the enlarged prostate in benign prostatic hyperplasia⁽¹¹⁵⁾.

Although many patients respond to ADT initially, they often relapse as they develop a castration-resistant prostate cancer (CRPC) state⁽¹¹⁶⁾. The mechanisms behind CRPC are not fully understood, but it is apparent that signaling via the AR often continues to be crucial for prostate tumor growth despite low circulating levels of T. Besides local androgen synthesis by the PC cells, hypersensitive ARs as a result of AR mutations have been demonstrated in CRPC cells⁽¹¹⁷⁻¹¹⁹⁾. Therefore, it may still be worth targeting the AR signaling pathway by use of AR antagonists (also called antiandrogens) in the treatment of CRPC. First-generation antiandrogens (e.g. bicalutamide, nilutamide, flutamide) block the androgen-binding site of the AR whereas second-generation antiandrogens have a wider range of mechanisms. Enzalutamide and apalutamide are both second-generation, nonsteroidal antiandrogens^(120,121). They affect the AR signaling pathway in at least three different ways: they bind to the AR with great affinity, reduce the efficiency of AR nuclear translocation, and impair both DNA binding to androgen response elements and recruitment of coactivators^(120,121). Enzalutamide is given to patients with metastatic CRPC either before⁽¹²²⁾ or after chemotherapy⁽¹²³⁾. However, since July 2018, enzalutamide is approved by the U.S. Food and Drug Administration (FDA) for the treatment also of non-metastatic CRPC (nmCRPC)⁽¹²⁴⁾. Apalutamide has also recently been approved by the FDA as a treatment for patients with nmCRPC⁽¹²⁵⁾. The side effects of these second-generation nonsteroidal antiandrogens on the skeleton are unclear.

1.14 Selective androgen receptor modulators (SARMs)

A recent randomized placebo-controlled study demonstrated that T treatment increased volumetric BMD in men with slightly low serum T⁽¹²⁶⁾. T treatment of men with severe hypogonadism results in increased sexual function, increased energy, slightly increased muscle mass, decreased fat mass, increased bone mineral density and increased hemoglobin levels^(127,128). However, treatment with T may lead to side effects such as an increased risk of cardiovascular diseases, increased risk of prostate cancer and very high levels of hemoglobin. Therefore, increased knowledge about the tissue-specific signaling mechanisms of androgens via the AR is needed for possible development of bone-specific SARMs with minimal side effects in other tissues. SARMs have been proposed as possible specific treatments for muscle-wasting and osteoporosis in men⁽¹²⁹⁾. SARMs were first described and subsequently developed by Dalton et al in 1998⁽¹³⁰⁾. Most of the SARMs developed thus far are non-steroidal and have the ability to activate the AR in muscle and bone^(129,131). Although there are ongoing clinical trials there is not yet any FDA or EMA approved SARM on the market.

2. Aims

The overall aim of this thesis was to increase the knowledge about the significance of the AR for bone metabolism to potentially identify bone-specific AR signaling pathways.

Specific aims

1. To evaluate the importance of the AR in immature osteoblast-lineage cells for trabecular and cortical bone mass in males (Paper I)
2. To characterize the effects of enzalutamide, an AR antagonist used in the treatment of prostate cancer, on bone metabolism (Paper II)
3. To determine the importance of the AR for adult bone metabolism, avoiding confounding effects during development (Paper III)
4. To elucidate the importance of SUMOylation of the AR for male bone metabolism (Paper IV)

3. Methodological considerations

3.1 Animal models

Mice are commonly used as models for studying different human diseases and treatments. They are inexpensive to breed since the generation time and lifespan are relatively short. Furthermore, the mouse genome is rather similar to the human genome and it can be manipulated relatively easily. Therefore, mouse models lacking or overexpressing certain genes can be developed and studied easily. In this thesis, the importance of the AR for bone metabolism is studied by use of the following different mouse models (Figure 7):

Paper I: Genetic inactivation of the AR specifically in osteoblast-lineage cells by use of a cell-specific Cre recombinase.

Paper II: Treatment with the AR antagonist enzalutamide.

Paper III: Inducible genetic inactivation of the AR by use of a tamoxifen-dependent Cre recombinase.

Paper IV: Genetic modulation of the AR SUMOylation sites K381R and K500R.

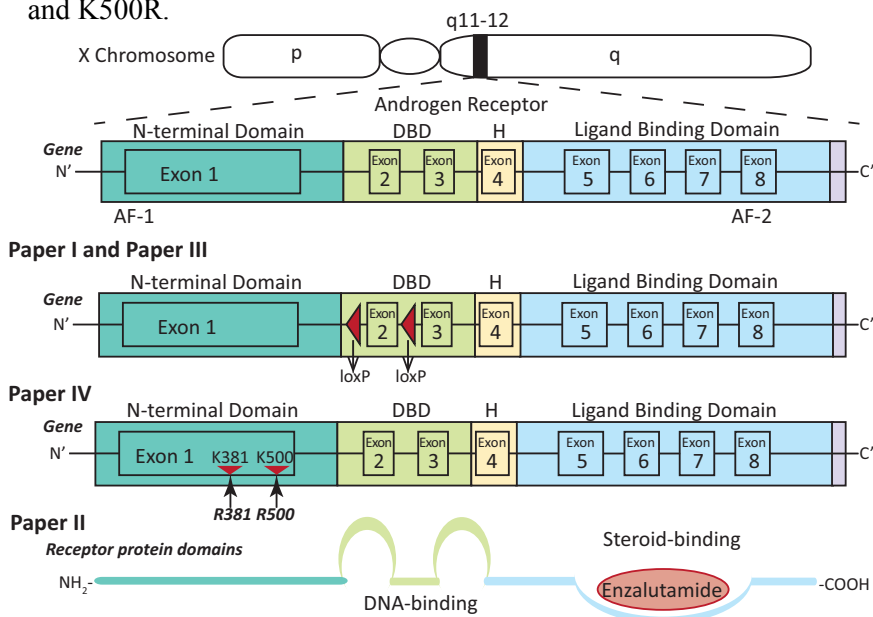

Figure 7 Illustration of the AR modifications used in this thesis. Adapted from "https://commons.wikimedia.org/wiki/File:Functional_domains_of_the_human_androgen_receptor.svg" by Wikimedia Commons. CC BY-SA 3.0.

3.1.1. Cre-*loxP* recombination system

The Cre-*loxP* recombination is a site-specific recombinase technology, used to achieve deletions, insertions, translocations and inversions at specific sites in the DNA of cells⁽¹³²⁻¹³⁴⁾. The Cre recombinase is a 38 kDa protein that is capable to recognize *loxP* sites, composed of two 13 bp inverted repeats interrupted by an 8 bp nonpalindromic sequence, in the genome. Cre-mediated recombination

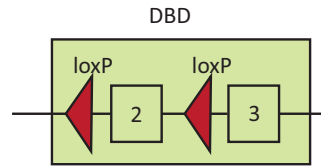

Figure 8 $AR^{+/flox}$ mice with exon 2 of AR flanked by *loxP* sites.

between two *loxP* sites results in the excision of the *loxP*-flanked, or “floxed,” DNA sequence. In Papers I and III, we mated genetically modified female mice heterozygous for the floxed exon 2 of the AR gene ($AR^{+/flox}$) with different male mouse models expressing the Cre (Figure 8)⁽¹³⁵⁾. In Paper I, the expression of Cre recombinase was driven by the osterix (*Osx1* or *Sp7*) promoter (#006361, the Jackson Laboratory)⁽¹³⁶⁾. In male AR^{flox} mice expressing *Osx1*-Cre, the Cre recombinase is expressed from the osteoprogenitor stage resulting in deletion of AR in osteoprogenitors as well as osteoblast precursors, mature osteoblasts, and osteocytes that all stem from the osteoprogenitors. These osteoblast-lineage cell-specific ARKO mice were called O-ARKO mice. Due to effects on the skeleton and body weight in *Osx1*-Cre transgenic mice^(137,138), *Osx1*-Cre expressing littermates without the AR^{flox} construct were used as controls.

In Paper III, the Cre recombinase-expressing transgenic mice are called CAG-CreER mice (#004682, the Jackson Laboratory)⁽¹³⁹⁾. These CAG-CreER transgenic mice express a tamoxifen-inducible Cre-mediated recombination system driven by the chicken beta actin promoter/enhancer coupled with the cytomegalovirus (CMV) immediate-early enhancer. The CreER fusion protein consists of Cre recombinase fused to a G525R mutant form of the mouse estrogen receptor (ER), which does not bind its natural ligand (17 β -estradiol) at physiological concentrations but will bind the synthetic ER ligand tamoxifen. The CreER fusion protein is restricted to the cytoplasm but after exposure to tamoxifen, it gains access to the nuclear compartment. Upon translocation to the nucleus the CreER fusion protein excises the floxed exon 2 of the AR (Figure 9). In Paper III, the AR was inactivated in an inducible manner at the age of 4 or 10 weeks.

Although this Cre transgenic system is well studied and known to have low background Cre activity in the absence of an inducer, previous reports indicate that the use of the tamoxifen-inducible Cre-*loxP* system is not without potential drawbacks^(140,141). Using correct controls are therefore fundamental. In Paper III, CAG-CreER expressing littermates without the AR^{fllox} construct were used as controls. Furthermore, tamoxifen is a SERM that has been reported to affect the skeleton^(142,143). The possible confounding effects of tamoxifen on the skeleton in Paper III were avoided by the fact that the control mice received the same dose of tamoxifen as the inducible ARKO mice.

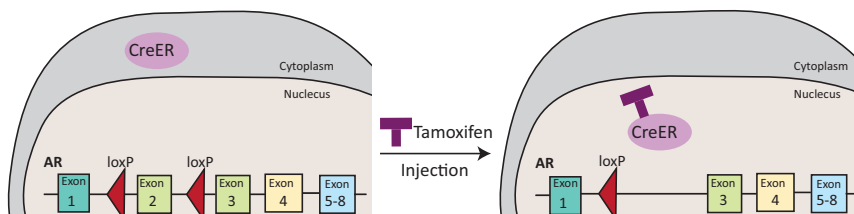

Figure 9 Schematic illustration of the strategy for induced AR inactivation by tamoxifen.

3.1.2. The AR^{SUM-} mouse model

The AR is activated by binding of a ligand, but the function of the AR is further regulated by PTMs, such as phosphorylation, ubiquitination and SUMOylation⁽¹⁴⁴⁾. When the AR is SUMOylated, small ubiquitin-related modifier proteins are covalently attached to two conserved lysine residues at the N-terminal transactivation domain of the AR. In humans, the SUMOylation sites of the AR are the lysine (K) at positions 386 and 520, corresponding to positions 381 and 500 in the mouse genome⁽⁷⁴⁾. To be able to study the importance of SUMOylation of the AR for bone metabolism (Paper IV), we have used the AR^{SUM-} mouse model, recently developed by our collaborators Prof. Poutanen and Prof. Palvimo at the University of Turku, Finland. The AR^{SUM-} mouse model is a knock-in mouse model in which the conserved lysines in the N-terminal domain of the AR were permanently abolished by converting them to arginines (R) (K381R, K500R) (Figure 10). Thereby, SUMOylation of the AR is blocked in this mouse model.

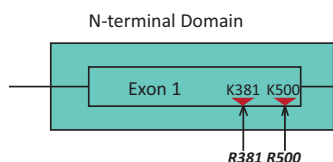

Figure 10 AR SUMOylation is inhibited by lysine to arginine mutations at SUMO sites.

3.2 Dual-energy X-ray absorptiometry (DXA)

Dual-energy X-ray absorptiometry (DXA) is the most frequently used approach for bone mineral density measurement in both clinical practice and animal research. It is a non-invasive method, which is an advantage when longitudinal studies are performed. Due to the two emitted X-ray beams with different energy levels, the DXA can distinguish between bone and soft tissue, since these tissues absorb energy differently. However, one important disadvantage with the DXA technique is that the images produced are two-dimensional (2D). The DXA, therefore, only recognizes changes in length and width and does not account for changes in the third dimension, which might become a problem when examining growing animals with major skeletal changes in size. The areal bone mineral density (aBMD; g/cm^2) as determined by DXA should not be mistaken for true volumetric BMD (vBMD; g/cm^3). In Papers I-III, DXA measurements were performed on all mouse models directly before termination using the Lunar PIXImus mouse densitometer (Wipro GE Healthcare, Madison, WI, USA) with a pixel size of 500 μm .

3.3 Micro-computed tomography (μCT)

Micro-computed tomography (μCT) is a non-invasive imaging technique for detailed bone analysis. In contrast to DXA, μCT uses X-ray attenuation data acquired at multiple viewing angles to reconstruct a three-dimensional (3D) representation of the bone that characterizes the spatial distribution of material density(145,146). The μCT can separate the trabecular bone from cortical bone and also provides the bone dimensions. Currently available μCT scanners achieve an isotropic voxel size as low as a few μm , which is sufficient to investigate bone microstructures such as trabecular bone microstructure and cortical porosity in mice. Therefore, μCT has become the “gold standard” for *ex vivo* evaluations of bone morphology and microarchitecture of the skeleton in mouse models and other small animal models.

The *ex vivo* bone sample is placed on a rotating stage between an X-ray generator and a charge-coupled detector (CCD) array. X-rays pass through the sample and the radiograph is recorded by the detector. The sample is rotated and another projection is taken at the new position. The procedure is repeated until the sample has rotated 180 degrees and a

complete set of radiographs has been produced. The set of X-ray projection images is then computed into 2D cross-sectional images through the computational process called reconstruction. The individual 2D slices are stacked to create a 3D volume used for quantitative analyses, such as bone volume/total volume (BV/TV), trabecular thickness (Tb.Th), trabecular number (Tb.N), trabecular separation (Tb.Sp), cortical thickness (Ct.Th), and cortical porosity (Ct.Po). In Papers I-IV, a SkyScan 1172 scanner (Bruker, Aartselaar, Belgium) with voxel size of 4.5 μm was used for μCT analyses.

3.4 Biomechanical testing

Although μCT analysis can reveal detailed information on bone structure in three dimensions, destructive three-point bending (long bones) and compression testing (vertebrae) provide important biomechanical parameters of bone strength and toughness. Determination of the mechanical properties by three-point bending of the long bones is performed by positioning the bone horizontally on two supports, and applying a single-pronged loading device to the opposite surface at a point precisely in the middle of the two supports⁽¹⁴⁷⁾. A gradually increased force is applied until the bone eventually breaks. During this process, the stress-strain responsive curve of the bone is measured. Initially, the relationship between the force exerted on the bone and the strain of the bone is linear and this linear slope corresponds to the stiffness of the bone. The force applied when the bone breaks is the maximum load, given in the unit Newton. In Papers II-IV, biomechanical testing of the long bones was performed using the Instron 3366 biomechanical testing machine (Instron Corp., Norwood, MA, USA).

In contrast to the three-point bending test that mainly measures the cortical bone strength, the compression test is commonly used to assess the biomechanical properties of the trabecular bone, which is present in large quantities in the vertebrae. During the compression test in Paper II, the intact vertebrae were axially loaded using the above mentioned Instron 3366 testing machine, measuring the stress-strain response curve of the vertebral body.

3.5 Histomorphometric analyses

While high-resolution imaging techniques such as μ CT can provide information about bone mass and bone structure, they cannot provide information regarding the cellular composition and the bone formation in the bone. This can instead be analyzed by bone histomorphometry. After fixation, dehydration, and defatting in xylene, the undecalcified bones are embedded in a plastic resin. It is important that the density of the resin and bone are closely matched. For static analyses of the bones, 4 μ m thick sections were stained with Masson-Goldner trichrome whereas unstained 8 μ m thick sections were analyzed for dynamic parameters. Static analyses of trabecular bone included parameters such as bone volume/total volume (BV/TV), trabecular thickness (Tb.Th), trabecular number (Tb.N) and trabecular separation (Tb.Sp); whereas in cortical bone analyses, total bone area (B.Ar), marrow cavity area (Ma.Ar), and cortical bone area (Ct.Ar) can be studied. Furthermore, the number and surface area of osteoblasts, and osteoclasts on bone surfaces as well as osteocyte density within the bone can be analyzed.

Dynamic parameters of bone formation such as mineral apposition rate and mineralized surface per bone surface are analyzed by using the fluorescent markers. One and eight days before sacrifice, the mice were labeled with intraperitoneal injections of the fluorochromes calcein or alizarin. These compounds are calcium-seeking substances that are incorporated into the mineralization front of mineralizing surfaces, which can then be visualized in histological specimens by their fluorescence under excitation with ultraviolet (UV) light.

3.6 Serum measurements

Bone turnover can also be assessed by measurement of formation and degradation products of bone matrix elements in the serum. In Papers I-III, commercially available enzyme-linked immunosorbent assays (ELISAs) were used to measure serum osteocalcin, a marker for bone formation, and serum CTX-I, which is a bone-related degradation product from C-terminal telopeptides of type I collagen.

Serum levels of sex steroids were measured in Papers II-IV by gas chromatography-tandem mass spectrometry (GC-MS/MS). This method

was recently established by co-workers at the Centre for Bone and Arthritis Research⁽⁹⁵⁾. In contrast to earlier available sex steroid measurement methods, this newly developed GC-MS/MS method is highly sensitive and specific for E2, E1, T, DHT, progesterone, androstenedione, and DHEA. This method is an improvement over previous methods for measuring sex steroid levels in rodents and represents a valuable contribution with respect to reference intervals in mice.

3.7 DNA and RNA quantification

The efficacy and specificity of the cell- and time-specific AR knockouts in Paper I and III, respectively, were analyzed by real-time quantitative PCR⁽¹⁴⁸⁾. The real-time qPCR technique allows quantification of the gene of interest by use of a pair of specific oligonucleotides as primers in the reaction. Added in the reaction is also a fluorochrome that fluoresces when excited.

In Paper I, the efficacy and specificity of the AR knockout (O-ARKO) in the osteoblasts were analyzed at the DNA level. Genomic DNA was prepared from the cortical bone of femur, spleen, bone marrow, thymus, liver, kidney, aorta, heart, skin, and testis. The O-ARKO mice have, as described above, a floxed exon 2, and in cells expressing Cre recombinase, exon 2 of the AR is deleted. In the real-time qPCR reaction, primers specific for DNA sequences within the exon 2 vs. exon 3 were used for relative quantification. The fluorochrome in this reaction was SYBR green, which fluoresces when bounds to double-stranded DNA.

In Paper III, AR inactivation was analyzed by measurement of the AR mRNA levels in different tissues. Using this method, total RNA was prepared and further transcribed into complementary DNA (cDNA). Pre-designed primers complementary to the cDNA sequence of interest was included in the reaction and amplification was then related to an internal standard. For the mRNA expression analyses, sequence-specific fluorophore labelled TaqMan probes were used. Expression of other genes of interest such as Cathepsin K and collagen type 1 alpha 1, was analyzed by the same method.

In Paper IV, real-time PCR analysis was used to examine if there was any change in AR mRNA levels after replacing two amino acids in the AR.

3.8 Western blot

In order to investigate the AR protein levels in different tissues following inactivation of SUMOylation sites of AR in Paper IV, Western blot was performed. Western blot is extensively used for qualitative detection of single proteins in a mixture and a semi-quantitative estimation of protein levels can be achieved. Denatured proteins were size-separated by gel electrophoresis followed by electrophoretic transfer onto a blot membrane. The AR protein was detected by incubation with a specific primary antibody followed by a TidyBlot HRP (horseradish peroxidase) conjugated detection reagent and Clarity Max Western ECL (enhanced chemiluminescence) substrate. The visualization was performed using a ChemiDoc System (Bio-Rad, Hercules, CA, USA). GAPDH (Glyceraldehyde-3-phosphate dehydrogenase) is constitutively expressed in almost all tissues in high amounts and for this reason, it was used as a loading control.

4. Results

Below is a brief description and summary of the results of the four papers included in the thesis. For more details, see the full papers at the end of the thesis.

4.1 Paper I

Androgens regulate bone marrow B lymphopoiesis in male mice by targeting osteoblast-lineage cells

In this study we evaluated the importance of the AR in immature osteoblast-lineage cells for trabecular and cortical bone mass in young adult male mice.

We specifically deleted the AR in immature osteoblast-lineage cells by mating AR^{fl^{ox}} mice with Osx1-Cre mice. Osx1-Cre is expressed in the osteoprogenitor stage and as a result, the AR is deleted in the osteoblast-lineage starting already at the osteoprogenitor stage⁽¹³⁶⁾.

Mice with no expression of the AR in immature osteoblast-lineage cells (O-ARKO) displayed significantly affected trabecular bone in the vertebrae, reflected by reduced trabecular number. In contrast, the cortical bone mass was unaffected. Furthermore, the serum levels of both the bone formation marker osteocalcin and the bone resorption marker CTX-I were significantly increased in O-ARKO mice compared with WT mice. This suggests an elevated bone turnover in these mice compared with WT mice.

In conclusion, AR deficiency in osteoblast-lineage cells reduced the trabecular number in vertebrae, whereas cortical bone mass was unaffected, supporting the notion that the AR in osteoblast-lineage cells is involved in the regulation of trabecular but not cortical bone homeostasis.

4.2 Paper II

Enzalutamide reduces the bone mass in the axial but not the appendicular skeleton in male mice

In this study, we evaluated the effect of enzalutamide, an AR antagonist used in the treatment of prostate cancer, on adult bone metabolism.

Nine-week-old WT male mice were treated with 10, 30, or 100 mg/kg·d of enzalutamide for 21 days or were surgically castrated (ADT) and were compared with vehicle-treated gonadal intact mice. The effects on the skeleton and on several other androgen-responsive tissues were evaluated.

While orchidectomy (orx) reduced the cortical bone thickness and trabecular bone volume fraction in the appendicular skeleton, these parameters were unaffected by enzalutamide. In contrast, both enzalutamide and orx reduced the bone mass in the axial skeleton as demonstrated by reduced lumbar spine areal BMD ($p < 0.001$) and trabecular bone volume fraction in L₅ vertebrae ($p < 0.001$) compared with vehicle-treated gonadal intact mice. A compression test of the L₅ vertebrae revealed a significantly reduced maximal load at failure by enzalutamide treatment, demonstrating a reduced mechanical strength in the axial skeleton induced by enzalutamide treatment. The bone loss in the axial skeleton by enzalutamide treatment was associated with a high bone turnover.

We conclude that enzalutamide reduces the bone mass in the axial but not the appendicular skeleton in young adult male mice. Surgical castration, affecting both estrogenic and androgenic pathways in bone, increases the risk of both vertebral and non-vertebral fractures in males, whereas our present findings suggest that antiandrogen treatment with enzalutamide may increase vertebral but not non-vertebral fracture risk in PC patients.

4.3 Paper III

The androgen receptor is required for maintenance of bone mass in adult male mice

In this study, we determined the importance of the AR for pubertal and adult bone homeostasis.

The AR was conditionally ablated at four (pre-pubertal) and ten (post-pubertal) weeks of age in male mice using tamoxifen-inducible Cre-mediated recombination of CAG-CreER;AR^{fllox/y} mice. At four and ten weeks of age, tamoxifen was administered i.p. for three or four consecutive days, respectively (50 mg/mouse/day). CAG-AR^{fllox/y} mice did not have any bone phenotype and, therefore, tamoxifen treated CAG-CreER;AR^{fllox/y} mice were compared with tamoxifen-treated CAG-CreER;AR^{+y} control mice at 14 weeks of age.

Both the pre-pubertal and the post-pubertal AR inactivation were efficient as demonstrated by substantially lower AR mRNA levels in seminal vesicles, bone and white adipose tissue as well as markedly reduced weights of reproductive tissues when comparing the inducible ARKO mice and control mice at 14 weeks of age. Serum T levels were not affected by post-pubertal AR inactivation while pre-pubertal AR inactivation resulted in increased serum T levels. Both pre- and post-pubertal AR inactivation increased serum DHT levels resulting in significantly increased serum DHT/T ratios associated with increased expression of *Srd5a2*, encoding 5 α -reductase type 2, in the seminal vesicles. These findings indicate that the synthesis of the potent androgen DHT by 5 α -reductase type 2 is subject to local negative feed-back regulation mediated by the AR. Total body BMD, as analyzed by DXA, as well as tibia diaphyseal cortical bone thickness and proximal metaphyseal trabecular bone volume fraction, as analyzed by μ CT, were significantly reduced by both pre-pubertal and post-pubertal AR inactivation. These bone effects were associated with increased bone turnover, indicating high bone turnover osteoporosis. Pre-pubertal but not post-pubertal AR inactivation resulted in substantially increased fat mass.

In conclusion, AR is required for maintenance of both the trabecular and cortical bone in adult male mice. By comparing pre-pubertal and post-pubertal AR inactivation, we conclude that adult AR expression is crucial

for trabecular and cortical bone mass maintenance while pubertal AR expression is crucial for normal fat mass homeostasis in adult male mice.

4.4 Paper IV

Androgen receptor SUMOylation regulates bone mass in male mice

In this paper, we elucidate the importance of SUMOylation of the AR for adult male bone metabolism.

We generated a mouse model devoid of two of the AR SUMOylation sites (AR^{SUM-} mice) by introducing two point mutations, K381R and K500R (two lysine residues mutated to arginine) and evaluated the skeletal phenotype.

Six-month-old AR^{SUM-} mice displayed normal body weight and had normal serum T levels. In addition, the weights of two well-established androgen-responsive tissues, seminal vesicles and the muscle levator ani, were not significantly altered. Male AR^{SUM-} mice displayed significantly reduced trabecular bone volume fraction in the distal metaphyseal region of femur compared with WT mice. The number of osteoblasts per bone perimeter was substantially reduced while no significant effect was observed on the number of osteoclasts in the trabecular bone of male AR^{SUM-} mice compared with WT mice. The bone formation rate was reduced as a result of reduced mineralizing surface per bone surface in AR^{SUM-} mice compared with WT mice. Finally, there was a moderate reduction in the cortical bone thickness in the diaphyseal region of femur in male AR^{SUM-} mice compared with WT mice.

We conclude that mice devoid of AR SUMOylation have reduced trabecular bone mass as a result of reduced bone formation. We propose that therapies enhancing AR SUMOylation might result in bone-specific anabolic effects with minimal adverse effects in other tissues.

5. Discussion

5.1 AR expression in immature osteoprogenitor cells affects trabecular but not cortical bone

It is clear that the AR plays an important role for the homeostasis of the male skeleton since both men with hypogonadism and men with complete androgen insensitivity syndrome because of a loss-of-function mutation in the AR, have low bone mass^(83,149). In addition, experimental mouse studies demonstrate that global deletion of the AR in male mice results in decreased trabecular as well as cortical bone mass due to high bone turnover and increased bone resorption^(100,102). However, although these global AR knockout mouse models have provided important insights, mice ubiquitously lacking the AR also have significant reductions in circulating T levels. Therefore, it has been unclear whether the reduced bone mass in these mouse models is the result of loss of AR expression in bone cells, or the concomitant hypogonadism.

More conclusive data for the role of the AR in bone metabolism have come from studies using the *Cre-loxP* technology for cell-specific deletions. A number of studies have used different osteoblast-lineage specific Cre models to delete the AR at different stages of osteoblast differentiation⁽¹⁵⁰⁾, by crossing transgenic mice expressing the Cre recombinase specifically under the control of either the collagen 1 α 1- (*Col1 α 1*-), osteocalcin- (*Ocn*-) or dentin matrix acidic phosphoprotein 1- (*Dmp1*-) promoter, with floxed AR mice. It has been demonstrated that deletion of the AR in mature osteoblasts or osteocytes results in osteopenia and increased bone resorption in trabecular, but not in cortical bone, of male mice^(101,106-108). However, these findings do not exclude the possibility that the effects of androgens on cortical bone mass may be mediated via AR signaling in immature osteoprogenitor cells.

To evaluate the hypothesis that AR expression in immature osteoprogenitor cells is important for the cortical bone homeostasis, the AR gene was in Paper I deleted by crossing transgenic mice expressing Cre recombinase under the control of the osterix promoter with floxed AR mice (O-ARKO). Osterix is a critical transcription factor essential for early osteoblast differentiation⁽¹⁵¹⁾. In contrast to collagen 1 α 1,

osteocalcin and *dmp1*, *osterix* is expressed by the immature osteoprogenitor cells, which is earlier in the differentiation process of osteoblasts compared to when the other genes are expressed.

The male O-ARKO mice displayed trabecular bone loss due to reduced trabecular number. In addition, analyses of serum markers for bone formation and bone resorption demonstrated that the O-ARKO mice had a high bone turnover. Moreover, neither cortical thickness nor cortical volumetric BMD was affected in the O-ARKO mice. The results from Paper I are consistent with the results from the earlier publications^(101,106-108), demonstrating that AR in osteoblast-lineage cells is specifically important for the trabecular bone mass. Furthermore, data from Paper I add to previous results that AR expression neither in immature early osteoprogenitor cells nor in mature osteoblast-lineage cells has an impact on cortical bone mass.

Shortly after Paper I was published, Ucer *et. al* published an article describing an experiment in which they had crossed AR flox mice with mice expressing the Cre recombinase under the control of regulatory elements of the paired related homeobox 1 (*Prx1*) gene⁽¹⁵²⁾. This transgene is expressed in pluripotent mesenchymal progenitors and their progeny in the appendicular, but not the axial, skeleton⁽¹⁵³⁾. The results from the study performed by Ucer *et. al* confirmed the results in Paper I, demonstrating that AR expression in immature osteoprogenitor cells are not important for the cortical bone mass⁽¹⁵²⁾.

Taken together, six separate studies clearly demonstrate that the anti-resorptive effects of androgens on trabecular but not cortical bone result from AR-mediated actions in osteoblast-lineage cells. The fact that expression of AR in osteoblast-lineage cells is not important for the cortical bone is to some extent unexpected since there is a well-established effect of androgens on cortical bone mass and larger cortical bone dimensions are observed in males compared to females.

The target cell for AR-mediated effects on cortical bone mass remains to be identified and several attempts to solve this question have been done. The AR gene has been deleted in osteoclast-lineage cells by crossing *LysM-Cre* or *Ctsk-Cre* expressing mice with floxed AR mice but with no effect on neither cortical nor trabecular bone^(152,154). This indicates that the target cells for the AR action on cortical bone mass are outside the

bone. It has been suggested that the effects of AR on the cortical bone mass may be indirect via effects on cells within the bone marrow, muscle cells or nerve cells. But further studies investigating the primary target cells of importance for AR actions in cortical bone are clearly warranted^(94,155,156).

5.2 Effects of enzalutamide on bone

Prostate cancer is the most common type of cancer for men in Sweden and it is the second most frequently diagnosed cancer for men worldwide⁽¹⁵⁷⁾. Recommended treatments vary depending upon the stage of the disease, but ADT via surgical or medical castration is commonly used for metastatic prostate cancer⁽¹⁵⁸⁾. The endocrine treatments of prostate cancer either lower the androgen levels (ADT or abiraterone) or directly block the AR activity (antiandrogens such as enzalutamide).

Although skeletal side effects have been reported for ADT^(94,110), skeletal side effects of the newly approved second generation antiandrogens have not yet been thoroughly investigated. In Paper II we compared the skeletal side effect of the recently introduced antiandrogen enzalutamide and ADT using surgical castration in male mice. The three different doses of enzalutamide used were in the same range as previously used in different prostate cancer studies^(120,159). Enzalutamide treatment substantially reduced the weight of androgen responsive tissues, confirming the antiandrogen effects of the treatment.

The skeletal side effects of surgical castration were more pronounced, with substantially reduced bone mass in both the axial and the appendicular skeleton, compared with enzalutamide treatment that reduced the bone mass only in the axial skeleton. All three doses of enzalutamide treatment clearly reduced the lumbar spine aBMD, suggesting that AR-mediated effects are crucial for the maintenance of adult bone mass in the axial skeleton. The effect of enzalutamide on the trabecular bone mass in vertebrae was confirmed by μ CT and histomorphometric analyses, revealing that the inhibitory effect of enzalutamide on trabecular bone volume fraction was mainly the result of reduced trabecular number. Moreover, high dose enzalutamide treatment reduced the compressive bone strength of vertebrae to the same extent as surgical castration. In general, the more pronounced effect on bone mass

of surgical castration compared with enzalutamide treatment is most likely due to reductions in both T and E2 production after surgical castration, consequently leading to less stimulation of both the AR and ER α . In contrast, enzalutamide treatment only inhibits the actions via the AR. The ER α -mediated effects are important for the regulation of the bone mass in both the appendicular and the axial skeleton, demonstrated by previous studies using aromatase inhibitors, aromatase inactivation and ER α inactivation^(94,103,160).

A limitation with the present study is that the efficiency of AR blockage in the different bone compartments by enzalutamide treatment was not measured. Therefore, one cannot exclude the possibility that the AR blockage in the appendicular skeleton might be more incomplete as compared with the AR blockage in the axial skeleton, contributing to the site-specific effects of enzalutamide. Furthermore, since the mice in our study were treated only for 21 days, one cannot rule out the possibility that prolonged treatment, mimicking the clinical situation, might also affect the appendicular skeleton^(122,123,161).

Currently, enzalutamide is given as an additional treatment to patients with metastatic CRPC either before⁽¹²²⁾ or after chemotherapy⁽¹²³⁾. In July 2018, enzalutamide was also approved by the FDA for the treatment of nmCRPC⁽¹²⁴⁾. Thereby, enzalutamide is the first and only FDA-approved oral medication for both non-metastatic and metastatic CRPC. The updated label was based on results from the Phase 3 PROSPER trial, which demonstrated that the use of enzalutamide plus ADT significantly reduced the risk of developing metastasis or death compared to ADT alone in men with nmCRPC⁽¹⁶²⁾.

The expanded indication of the AR antagonist enzalutamide to chemically castrated patients, who are already depleted of the testicular-derived androgens, might not substantially increase the risk of vertebral fractures beyond the chemical castration effect. However in monotherapy, as enzalutamide also blocks the effects of adrenal-derived androgens, bone mass in the axial skeleton might be further reduced and increasing the risk of vertebral fractures compared with other treatments. A recent clinical phase 2 study of enzalutamide monotherapy in hormone-naïve prostate cancer of varying severity revealed that this treatment substantially reduced PSA levels, suggesting that enzalutamide monotherapy might, in the future, be considered as an early treatment also for men with hor-

hormone-naïve prostate cancer⁽¹⁶³⁾. Longitudinal BMD measurements by DXA were recently available in a small cohort of men treated with enzalutamide monotherapy for three years but no significant reduction in BMD was observed in this limited dataset with no placebo treated control group to compare⁽¹⁶¹⁾. The trend of minor decreases in BMD after three years of enzalutamide treatment in that study were less pronounced than the BMD decreases previously reported for long-term ADT⁽¹⁶⁴⁻¹⁶⁶⁾.

5.3 Presence of a functional AR in adult mice is required to maintain trabecular and cortical bone mass

One of the major concerns of the different models with global or cell-specific deletion of AR is that they all lack expression of the AR already since the time of conception. Therefore, from these models, it is impossible to elucidate the relative role of AR during development, sexual maturation and in adult mice. Likely, lack of AR expression during early development results in imprinting effects with health consequences later in life as well as development of redundant mechanisms that confound the interpretation of the role of the AR during adult life⁽¹⁶⁷⁾. Also, global deletion of the AR since time of conception affects the testicular development causing hypogonadism with low serum T levels^(100,102).

To overcome these problems and to be able to determine the importance of the AR specifically during sexual maturation and in adult male mice, an inducible knockout model system is required. Since 1995, when Kühn et al introduced an inducible inactivation of a target gene⁽¹⁶⁸⁾, different inducible knockout model systems have been developed, such as tetracycline- and tamoxifen-inducible systems^(169,170). The tamoxifen-induced system permanently manipulates the gene of interest. In the tamoxifen-induced mouse model, the Cre recombinase only enters the nucleus when tamoxifen is present and the deletion of the gene can be induced by systemic tamoxifen injections at time points selected by the investigator.

In Paper III of this thesis we used the tamoxifen-inducible system and developed mouse models with either pre-pubertal or post-pubertal AR inactivation. Efficient recombination was confirmed for both pre-pubertal and post-pubertal AR inactivation, demonstrated by decreased AR mRNA expression level in seminal vesicles and bones. Both pre-pubertal and post-pubertal AR inactivation reduced the trabecular as well as the cortical bone mass, mimicking the skeletal effects observed following life-long global AR inactivation^(100,102). These results clearly demonstrate that adult post-pubertal AR expression is required for maintenance of both the trabecular and cortical bone mass.

The reduced bone mass by inducible AR inactivation was associated with increased bone resorption, as demonstrated by elevated serum levels of the bone resorption marker CTX and increased mRNA levels of Cathepsin K in bone. These findings are consistent with previous reports from the global life-long ARKO models demonstrating high bone turnover osteoporosis mainly caused by increased bone resorption^(100,102).

Androgens are considered key determinants of male cortical radial bone growth and, similar to humans, androgens promote the expansion of the periosteum in growing male rodents. One may speculate that AR expression during sexual maturation is crucial for the cortical radial expansion in male mice. However, in the present study similar effects on the cortical bone was observed by pre-pubertal and post-pubertal AR inactivation, arguing against a specific role of the AR for cortical radial expansion during sexual maturation. A limitation with the present study was that we did not evaluate periosteal bone formation rate with the sensitive dynamic histomorphometric technique and, therefore, we cannot exclude minor effects on cortical radial bone expansion.

Longitudinal bone growth during sexual maturation in males is dependent on sex steroid actions⁽¹⁷¹⁾. The finding in the present study that longitudinal bone growth was not significantly affected by pre-pubertal AR inactivation supports previous human and animal studies demonstrating that longitudinal bone growth during sexual maturation in males is mainly regulated by estrogen acting on ER α ^(77,172-174).

In contrast to our finding that AR is required for the maintenance of both trabecular and cortical bone in adult male mice, pre-pubertal but not post-pubertal AR expression was required for the development of a normal fat

mass. Mice with pre-pubertal inactivation of AR had increased fat mass associated with elevated serum leptin levels. It is well-known that androgen deficiency is associated with obesity, metabolic syndrome, and type 2 diabetes mellitus in men, but the mechanisms behind these associations remain unclear⁽¹⁷⁵⁾. Previous studies have demonstrated that male mice with global lifelong inactivation of AR developed late onset obesity⁽¹⁷⁶⁾. Our findings together with previous studies using mice with global lifelong AR inactivation, indicate that AR expression during puberty is crucial for normal fat mass homeostasis in adult mice.

5.4 Role of post-translational modification of the AR in bone

AR signaling can be regulated by different PTMs, including phosphorylation, acetylation, SUMOylation, ubiquitination and methylation⁽⁷¹⁾. Most studies of the importance of PTMs are based on *in vitro* experiments, but recent *in vivo* studies have identified that PTMs of the AR are involved in the onset and progression of human diseases, including cancer. For instance, phosphorylation of the AR has been associated with hormone refractory prostate cancer and decreased disease-specific survival⁽¹⁷⁷⁻¹⁷⁹⁾. Furthermore, AR acetylation has been shown to modulate AR activity and prostate cancer cell survival^(180,181). The number of studies evaluating the effects of PTMs in different nuclear receptors for bone metabolism is limited, but we recently demonstrated that palmitoylation of ER α is required for a normal estrogenic response in bone^(182,183). However, the role of PTMs in the AR for bone metabolism is unknown.

In Paper IV, we demonstrate for the first time *in vivo* that SUMOylation of the AR regulates both cortical and trabecular bone mass. Mice devoid of the two SUMOylation sites (K381 and K500) displayed significantly reduced cortical bone thickness as well as trabecular bone mass in the long bones. The reduced trabecular bone mass was the result of reduced number of osteoblasts associated with reduced bone formation rate. These results suggest that SUMOylation of the AR increases AR transcriptional activity in the bone tissue.

Although the exact mechanism of action of the SUMOylation of the AR is not clarified, it has been suggested that AR SUMOylation is important

for the recruitment of coactivators and co-repressors⁽¹⁸⁴⁾. Based on previous *in vitro* studies, the SUMOylation was initially suggested to repress the transcriptional activity of the receptor^(74,75). However, recent genome-wide gene expression analyses of prostate cancer cells stably expressing SUMOylation-deficient AR demonstrated that the SUMOylation of the AR modulated the AR function in a target gene and pathway selective manner⁽⁷⁶⁾. In that study, SUMOylation of the AR mainly regulated pathways linked to cellular movement, cell death, cellular proliferation, cellular development and cell cycle. Kaikkonen et al also suggested *in vitro*, that the degree of SUMOylation of the AR depends on the binding of a ligand to the receptor, and unliganded AR or antagonist-bound AR are only weakly SUMOylated compared with agonist-bound AR⁽⁷⁵⁾.

Importantly, the male mice devoid of AR SUMOylation in Paper IV, were apparently healthy, displayed a normal longitudinal bone growth, had normal AR levels in bone and seminal vesicles and had no signs of disturbed feedback regulation of serum T. These findings demonstrate that the physiological role of AR SUMOylation *in vivo* is tissue-specific with a clear role for bone metabolism while some other major androgen-dependent tissues are unaffected, supporting the previous *in vitro* study suggesting that the SUMOylation of the AR modulates the AR function in a cell- or tissue specific manner⁽⁷⁶⁾. We propose that therapies enhancing AR SUMOylation might result in bone-specific anabolic effects with minimal adverse effects in other tissues.

6. Conclusions

Increased knowledge about the signaling mechanisms of androgens via the AR is needed for the development of new bone-specific SARMs with minimal systemic side effects. There is also a need for more knowledge about the skeletal effects of newly developed endocrine drugs used for treatment of prostate cancer. From the results presented in this thesis, we conclude that signaling mechanisms via the AR expressed by immature osteoblast-lineage cells are of importance for the androgenic effect on trabecular bone mass but not cortical bone mass. Furthermore, adult AR expression is required for the maintenance of both the trabecular and cortical bone in adult male mice. SUMOylation of the AR regulates bone mass but not the weights of androgen-responsive reproductive tissues, suggesting that therapies targeting AR SUMOylation might result in bone-specific anabolic effects with minimal adverse effects in other tissues. Finally, the recently developed antiandrogenic drug enzalutamide, used in clinical practice for treatment of prostate cancer patients, reduces the bone mass in the axial but not in the appendicular skeleton. The findings in this thesis may contribute to important knowledge for the development of new specific treatment options for men with osteoporosis and safer endocrine treatments with minimal skeletal side effects for men with prostate cancer.

7. Future perspective

In order to develop bone-specific SARMs with minimal adverse effects in other tissues, more knowledge about the signaling mechanisms of androgens via the AR is needed. In contrast to the variety of SERMs that have been developed to date for different purposes, few SARMs have advanced beyond phase II proof-of-concept and there is not yet any SARM approved by the FDA or EMA.

Results from this thesis demonstrate that AR expression in osteoblast-lineage cells is of no importance for the cortical bone of male mice. This is rather unexpected since androgens are known to regulate cortical bone mass. Furthermore, previous studies have shown that AR expression in osteoclasts is also not crucial for cortical bone mass^(152,154). These data demonstrate that the primary target cells for the AR action on cortical bone must be outside the bone. It has been suggested that the effects of AR on the cortical bone may be indirect via effects on cells within the bone marrow, muscle cells or nerve cells^(94,155,156). We believe that further studies investigating the primary target cells of importance for AR actions in cortical bone are clearly warranted.

Furthermore, targeting AR actions in a tissue-specific manner with minimal systemic adverse effects has been challenging. Importantly, in this thesis we demonstrate for the first time *in vivo* that manipulations of SUMOylation of the AR result in tissue-specific AR-mediated effects. Inactivation of AR SUMOylation reduced both cortical and trabecular bone mass whereas the weights of other androgen-sensitive organs such as seminal vesicles and the muscle levator ani were unaffected. New therapies enhancing AR SUMOylation might therefore result in bone-specific anabolic effects with minimal adverse effects in reproductive tissues. In this thesis, we did not study the exact mechanisms for the tissue-specific *in vivo* effects of AR SUMOylation. It has been suggested that SUMOylation of AR is important for the recruitment of different co-activators and co-repressors and it is likely that this regulation is dependent on the cell context. Further studies examining the cellular mechanisms behind the tissue-specific effects of AR SUMOylation are clearly warranted.

Enzalutamide is the first and only FDA-approved oral medication for both non-metastatic and metastatic castration-resistant prostate cancer.

Furthermore, a recent clinical Phase 2 study of enzalutamide monotherapy in hormone-naïve prostate cancer revealed that this treatment substantially reduced PSA levels, suggesting that enzalutamide monotherapy might, in the future, be considered as an early treatment for men with hormone-naïve prostate cancer. As we demonstrate in the present thesis that enzalutamide treatment reduces bone mass in the axial skeleton, we propose that the possible long term skeletal side effects of enzalutamide, especially when used as monotherapy, should be evaluated in a well-powered clinical study. However, based on the results in the present study, we anticipate that the skeletal side effects with enzalutamide monotherapy, affecting only androgenic signaling, will be less pronounced compared with the skeletal side effects of ADT, affecting both androgenic and estrogenic signaling pathways in the skeleton.

Related publications not included in the thesis

1. Moverare-Skrtic S, **Wu J**, Henning P, Gustafsson KL, Sjogren K, Windahl SH, Koskela A, Tuukkanen J, Borjesson AE, Lagerquist MK, Lerner UH, Zhang FP, Gustafsson JA, Poutanen M, Ohlsson C. The bone-sparing effects of estrogen and WNT16 are independent of each other. *Proc Natl Acad Sci U S A* 2015; 112:14972-14977
2. Gustafsson KL, Farman H, Henning P, Lionikaite V, Moverare-Skrtic S, **Wu J**, Ryberg H, Koskela A, Gustafsson JA, Tuukkanen J, Levin ER, Ohlsson C, Lagerquist MK. The role of membrane ERalpha signaling in bone and other major estrogen responsive tissues. *Sci Rep* 2016; 6:29473
3. Farman HH, **Wu J**, Gustafsson KL, Windahl SH, Kim SH, Katzenellenbogen JA, Ohlsson C, Lagerquist MK. Extra-nuclear effects of estrogen on cortical bone in males require ERalphaAF-1. *J Mol Endocrinol* 2017; 58:105-111
4. Gustafsson KL, Nilsson KH, Farman HH, Andersson A, Lionikaite V, Henning P, **Wu J**, Windahl SH, Islander U, Moverare-Skrtic S, Sjogren K, Carlsten H, Gustafsson JA, Ohlsson C, Lagerquist MK. ERalpha expression in T lymphocytes is dispensable for estrogenic effects in bone. *J Endocrinol* 2018; 238:129-136.
5. Jansson JO, Palsdottir V, Hagg DA, Schele E, Dickson SL, Anesten F, Bake T, Montelius M, Bellman J, Johansson ME, Cone RD, Drucker DJ, **Wu J**, Aleksic B, Tornqvist AE, Sjogren K, Gustafsson JA, Windahl SH, Ohlsson C. Body weight homeostat that regulates fat mass independently of leptin in rats and mice. *Proc Natl Acad Sci U S A* 2018; 115:427-432
6. Ohlsson C, Henning P, Nilsson KH, **Wu J**, Gustafsson KL, Sjogren K, Tornqvist A, Koskela A, Zhang FP, Lagerquist MK, Poutanen M, Tuukkanen J, Lerner UH, Moverare-Skrtic S. Inducible Wnt16 inactivation: WNT16 regulates cortical bone thickness in adult mice. *J Endocrinol* 2018; 237:113-122
7. Ohlsson C, Nilsson KH, Henning P, **Wu J**, Gustafsson KL, Poutanen M, Lerner UH, Moverare-Skrtic S. WNT16 Overexpression Partly Protects Against Glucocorticoid-induced Bone Loss. *Am J Physiol Endocrinol Metab* 2018; 314:E597-E604.

Acknowledgments

This thesis has been performed at the Centre for Bone and Arthritis Research (CBAR), Institute of Medicine, Sahlgrenska Academy, University of Gothenburg. I would like to express my sincere gratitude to all the people directly and indirectly that contributed to the completion of this thesis, especially to:

Sofia Movérare-Skrtic, my main supervisor. I am extremely grateful for your supervision and support during the past five years. Thank you for your patience and trust, without you, this thesis could not have been done.

Claes Ohlsson, my co-supervisor. Thank you for giving me the opportunity to join this fantastic bone group and for always being available when I have questions.

Anna Törnqvist and Anette Hansevi, thank you for teaching me how to use the μ CT machine, which gave me a lot of fun during my Ph.D. studies.

Helen Farman and Louise Grahnemo, thank you for the encouragements and fruitful talks.

Charlotta Ugglå, Biljana Aleksic, Ulrika Björklund, and Andreas Landin, thank you for the technical support in the lab.

Maria Bygdell, Lisa Horster, Maria Utterhall, and Anna-Lena Jirestedt, thank you for helping with the administration issues.

Liesbeth Vandenput and Hannah Colldén, thank you for proofreading this thesis.

I am also grateful for all the co-authors, thank you for giving me the opportunity to work with you and learn from you.

Karin Nilsson, Karin Gustafsson, Marie Lagerquist, Sara Windahl, Petra Henning, Klara Sjögren, Anna Westlund, Viktè Lionikaitè, and all other people at CBAR, thank you for the nice time at every fika and kick-off!

感谢可爱的朋友们一直以来的支持和帮助，是你们让原本枯燥的读博生活变得不孤单。

最后，感谢一直陪伴着我的爸爸和妈妈。虽远隔千里，但时刻挂念。谢谢你们的理解与支持，让我来到这个遥远的北国，完成了这样一段意料之外的求学之旅。

References

1. Zebaze RM, Ghasem-Zadeh A, Bohte A, Iuliano-Burns S, Mirams M, Price RI, et al. Intracortical remodelling and porosity in the distal radius and post-mortem femurs of women: a cross-sectional study. *Lancet*. May 15 2010;375(9727):1729-36.
2. Datta HK, Ng WF, Walker JA, Tuck SP, Varanasi SS. The cell biology of bone metabolism. *J Clin Pathol*. May 2008;61(5):577-87.
3. Riggs BL, Wahner HW, Seeman E, Offord KP, Dunn WL, Mazess RB, et al. Changes in bone mineral density of the proximal femur and spine with aging. Differences between the postmenopausal and senile osteoporosis syndromes. *J Clin Invest*. Oct 1982;70(4):716-23.
4. Eastell R, Mosekilde L, Hodgson SF, Riggs BL. Proportion of human vertebral body bone that is cancellous. *J Bone Miner Res*. Dec 1990;5(12):1237-41.
5. da Silva Meirelles L, Chagastelles PC, Nardi NB. Mesenchymal stem cells reside in virtually all post-natal organs and tissues. *J Cell Sci*. Jun 1 2006;119(Pt 11):2204-13.
6. Pittenger MF, Mackay AM, Beck SC, Jaiswal RK, Douglas R, Mosca JD, et al. Multilineage potential of adult human mesenchymal stem cells. *Science*. Apr 2 1999;284(5411):143-7.
7. Jensen ED, Gopalakrishnan R, Westendorf JJ. Regulation of gene expression in osteoblasts. *Biofactors*. Jan-Feb 2010;36(1):25-32.
8. Komori T, Yagi H, Nomura S, Yamaguchi A, Sasaki K, Deguchi K, et al. Targeted disruption of *Cbfa1* results in a complete lack of bone formation owing to maturational arrest of osteoblasts. *Cell*. May 30 1997;89(5):755-64.
9. Muraglia A, Cancedda R, Quarto R. Clonal mesenchymal progenitors from human bone marrow differentiate in vitro according to a hierarchical model. *J Cell Sci*. Apr 2000;113 (Pt 7):1161-6.
10. Walker DG. Bone resorption restored in osteopetrotic mice by transplants of normal bone marrow and spleen cells. *Science*. Nov 21 1975;190(4216):784-5.
11. Feng X, Teitelbaum SL. Osteoclasts: New Insights. *Bone Res*. Mar 2013;1(1):11-26.
12. Nakagawa N, Kinoshita M, Yamaguchi K, Shima N, Yasuda H, Yano K, et al. RANK is the essential signaling receptor for osteoclast

differentiation factor in osteoclastogenesis. *Biochem Biophys Res Commun.* Dec 18 1998;253(2):395-400.

13. Hsu H, Lacey DL, Dunstan CR, Solovyev I, Colombero A, Timms E, et al. Tumor necrosis factor receptor family member RANK mediates osteoclast differentiation and activation induced by osteoprotegerin ligand. *Proc Natl Acad Sci U S A.* Mar 30 1999;96(7):3540-5.
14. Karaplis AC. Chapter 3 - Embryonic Development of Bone and Regulation of Intramembranous and Endochondral Bone Formation. In: Bilezikian JP, Raisz LG, Martin TJ, editors. *Principles of Bone Biology (Third Edition)*. San Diego: Academic Press; 2008. p. 53-84.
15. Schmeling A, Schulz R, Reisinger W, Muhler M, Wernecke KD, Geserick G. Studies on the time frame for ossification of the medial clavicular epiphyseal cartilage in conventional radiography. *Int J Legal Med.* Feb 2004;118(1):5-8.
16. Langdahl B, Ferrari S, Dempster DW. Bone modeling and remodeling: potential as therapeutic targets for the treatment of osteoporosis. *Ther Adv Musculoskelet Dis.* Dec 2016;8(6):225-35.
17. Clarke B. Normal bone anatomy and physiology. *Clin J Am Soc Nephrol.* Nov 2008;3 Suppl 3:S131-9.
18. Gilsanz V, Kovanlikaya A, Costin G, Roe TF, Sayre J, Kaufman F. Differential effect of gender on the sizes of the bones in the axial and appendicular skeletons. *J Clin Endocrinol Metab.* May 1997;82(5):1603-7.
19. Nieves JW, Formica C, Ruffing J, Zion M, Garrett P, Lindsay R, et al. Males have larger skeletal size and bone mass than females, despite comparable body size. *J Bone Miner Res.* Mar 2005;20(3):529-35.
20. Vanderschueren D, Vandenput L, Boonen S, Lindberg MK, Bouillon R, Ohlsson C. Androgens and bone. *Endocr Rev.* Jun 2004;25(3):389-425.
21. Riggs BL, Melton Iii LJ, 3rd, Robb RA, Camp JJ, Atkinson EJ, Peterson JM, et al. Population-based study of age and sex differences in bone volumetric density, size, geometry, and structure at different skeletal sites. *J Bone Miner Res.* Dec 2004;19(12):1945-54.
22. Seeman E, Delmas PD. Bone quality--the material and structural basis of bone strength and fragility. *N Engl J Med.* May 25 2006;354(21):2250-61.
23. Frost HM. Tetracycline-based histological analysis of bone remodeling. *Calcif Tissue Res.* 1969;3(3):211-37.
24. Smith SY, Varela A, Samadfam R. *Bone Toxicology*: Springer International Publishing; 2017.

25. Parfitt AM. Misconceptions (2): turnover is always higher in cancellous than in cortical bone. *Bone*. Jun 2002;30(6):807-9.
26. Sims NA, Martin TJ. Coupling the activities of bone formation and resorption: a multitude of signals within the basic multicellular unit. *Bonekey Rep*. Jan 8 2014;3:481.
27. Johnell O, Kanis JA. An estimate of the worldwide prevalence and disability associated with osteoporotic fractures. *Osteoporos Int*. Dec 2006;17(12):1726-33.
28. World Health Organization. Assessment of fracture risk and its application to screening for postmenopausal osteoporosis. Report of a WHO Study Group. *World Health Organ Tech Rep Ser*. 1994;843:1-129.
29. Hudec SM, Camacho PM. Secondary causes of osteoporosis. *Endocr Pract*. Jan-Feb 2013;19(1):120-8.
30. Emkey GR, Epstein S. Secondary osteoporosis: pathophysiology & diagnosis. *Best Pract Res Clin Endocrinol Metab*. Dec 2014;28(6):911-35.
31. Coleman R, Body JJ, Aapro M, Hadji P, Herrstedt J, Group EGW. Bone health in cancer patients: ESMO Clinical Practice Guidelines. *Ann Oncol*. Sep 2014;25 Suppl 3:iii124-37.
32. Guise TA. Bone loss and fracture risk associated with cancer therapy. *Oncologist*. Nov-Dec 2006;11(10):1121-31.
33. Guntur AR, Doucette CR, Rosen CJ. PTHrp comes full circle in cancer biology. *Bonekey Rep*. 2015;4:621.
34. Tawara K, Oxford JT, Jorcyk CL. Clinical significance of interleukin (IL)-6 in cancer metastasis to bone: potential of anti-IL-6 therapies. *Cancer Manag Res*. 2011;3:177-89.
35. Rizzoli R, Body JJ, Brandi ML, Cannata-Andia J, Chappard D, El Maghraoui A, et al. Cancer-associated bone disease. *Osteoporos Int*. Dec 2013;24(12):2929-53.
36. Coleman RE, Rathbone E, Brown JE. Management of cancer treatment-induced bone loss. *Nat Rev Rheumatol*. Jun 2013;9(6):365-74.
37. Riggs BL, Melton LJ, Robb RA, Camp JJ, Atkinson EJ, McDaniel L, et al. A population-based assessment of rates of bone loss at multiple skeletal sites: evidence for substantial trabecular bone loss in young adult women and men. *J Bone Miner Res*. Feb 2008;23(2):205-14.
38. Curtis JR, Adachi JD, Saag KG. Bridging the osteoporosis quality chasm. *J Bone Miner Res*. Jan 2009;24(1):3-7.

39. Bliuc D, Nguyen ND, Milch VE, Nguyen TV, Eisman JA, Center JR. Mortality risk associated with low-trauma osteoporotic fracture and subsequent fracture in men and women. *JAMA*. Feb 4 2009;301(5):513-21.
40. Unnanuntana A, Gladnick BP, Donnelly E, Lane JM. The assessment of fracture risk. *J Bone Joint Surg Am*. Mar 2010;92(3):743-53.
41. Schurer C, Wallaschofski H, Nauck M, Volzke H, Schober HC, Hannemann A. Fracture Risk and Risk Factors for Osteoporosis. *Dtsch Arztebl Int*. May 25 2015;112(21-22):365-71.
42. Kanis JA, Johnell O, Oden A, Johansson H, McCloskey E. FRAX and the assessment of fracture probability in men and women from the UK. *Osteoporos Int*. Apr 2008;19(4):385-97.
43. Belanger B, Belanger A, Labrie F, Dupont A, Cusan L, Monfette G. Comparison of residual C-19 steroids in plasma and prostatic tissue of human, rat and guinea pig after castration: unique importance of extratesticular androgens in men. *J Steroid Biochem*. May 1989;32(5):695-8.
44. Huhtaniemi R, Oksala R, Knuutila M, Mehmood A, Aho E, Laajala TD, et al. Adrenals Contribute to Growth of Castration-Resistant VCaP Prostate Cancer Xenografts. *Am J Pathol*. Sep 28 2018.
45. Plant TM, Marshall GR. The functional significance of FSH in spermatogenesis and the control of its secretion in male primates. *Endocr Rev*. Dec 2001;22(6):764-86.
46. Plant TM. 60 YEARS OF NEUROENDOCRINOLOGY: The hypothalamo-pituitary-gonadal axis. *J Endocrinol*. Aug 2015;226(2):T41-54.
47. Thigpen AE, Silver RI, Guileyardo JM, Casey ML, McConnell JD, Russell DW. Tissue distribution and ontogeny of steroid 5 alpha-reductase isozyme expression. *J Clin Invest*. Aug 1993;92(2):903-10.
48. Chang KH, Li R, Papari-Zareei M, Watumull L, Zhao YD, Auchus RJ, et al. Dihydrotestosterone synthesis bypasses testosterone to drive castration-resistant prostate cancer. *Proc Natl Acad Sci U S A*. Aug 16 2011;108(33):13728-33.
49. Kaufman JM, Vermeulen A. The decline of androgen levels in elderly men and its clinical and therapeutic implications. *Endocr Rev*. Oct 2005;26(6):833-76.
50. Tsai MJ, O'Malley BW. Molecular mechanisms of action of steroid/thyroid receptor superfamily members. *Annu Rev Biochem*. 1994;63:451-86.

51. Li J, Al-Azzawi F. Mechanism of androgen receptor action. *Maturitas*. Jun 20 2009;63(2):142-8.
52. Fujimoto J, Nishigaki M, Hori M, Ichigo S, Itoh T, Tamaya T. The effect of estrogen and androgen on androgen receptors and mRNA levels in uterine leiomyoma, myometrium and endometrium of human subjects. *J Steroid Biochem Mol Biol*. Aug 1994;50(3-4):137-43.
53. Ruizeveld de Winter JA, Trapman J, Vermeij M, Mulder E, Zegers ND, van der Kwast TH. Androgen receptor expression in human tissues: an immunohistochemical study. *J Histochem Cytochem*. Jul 1991;39(7):927-36.
54. Sinha-Hikim I, Taylor WE, Gonzalez-Cadavid NF, Zheng W, Bhasin S. Androgen receptor in human skeletal muscle and cultured muscle satellite cells: up-regulation by androgen treatment. *J Clin Endocrinol Metab*. Oct 2004;89(10):5245-55.
55. Lubahn DB, Joseph DR, Sar M, Tan J, Higgs HN, Larson RE, et al. The human androgen receptor: complementary deoxyribonucleic acid cloning, sequence analysis and gene expression in prostate. *Mol Endocrinol*. Dec 1988;2(12):1265-75.
56. Chang CS, Kokontis J, Liao ST. Molecular cloning of human and rat complementary DNA encoding androgen receptors. *Science*. Apr 15 1988;240(4850):324-6.
57. Gelmann EP. Molecular biology of the androgen receptor. *J Clin Oncol*. Jul 1 2002;20(13):3001-15.
58. Lavery DN, McEwan IJ. Functional characterization of the native NH2-terminal transactivation domain of the human androgen receptor: binding kinetics for interactions with TFIIF and SRC-1a. *Biochemistry*. Mar 18 2008;47(11):3352-9.
59. Watt K, McEwan IJ. Using intrinsic fluorescence emission spectroscopy to study steroid receptor and coactivator protein conformation dynamics. *Methods Mol Biol*. 2009;505:205-18.
60. Simental JA, Sar M, Lane MV, French FS, Wilson EM. Transcriptional activation and nuclear targeting signals of the human androgen receptor. *J Biol Chem*. Jan 5 1991;266(1):510-8.
61. Verrijdt G, Tanner T, Moehren U, Callewaert L, Haelens A, Claessens F. The androgen receptor DNA-binding domain determines androgen selectivity of transcriptional response. *Biochem Soc Trans*. Dec 2006;34(Pt 6):1089-94.
62. Clinckemalie L, Vanderschueren D, Boonen S, Claessens F. The hinge region in androgen receptor control. *Mol Cell Endocrinol*. Jul 6 2012;358(1):1-8.

63. Haelens A, Tanner T, Denayer S, Callewaert L, Claessens F. The hinge region regulates DNA binding, nuclear translocation, and transactivation of the androgen receptor. *Cancer Res.* May 1 2007;67(9):4514-23.
64. Askew EB, Gampe RT, Jr., Stanley TB, Faggart JL, Wilson EM. Modulation of androgen receptor activation function 2 by testosterone and dihydrotestosterone. *J Biol Chem.* Aug 31 2007;282(35):25801-16.
65. Bevan CL, Hoare S, Claessens F, Heery DM, Parker MG. The AF1 and AF2 domains of the androgen receptor interact with distinct regions of SRC1. *Mol Cell Biol.* Dec 1999;19(12):8383-92.
66. Culig Z, Hobisch A, Cronauer MV, Radmayr C, Trapman J, Hittmair A, et al. Androgen receptor activation in prostatic tumor cell lines by insulin-like growth factor-I, keratinocyte growth factor, and epidermal growth factor. *Cancer Res.* Oct 15 1994;54(20):5474-8.
67. Chang YM, Bai L, Liu S, Yang JC, Kung HJ, Evans CP. Src family kinase oncogenic potential and pathways in prostate cancer as revealed by AZD0530. *Oncogene.* Oct 23 2008;27(49):6365-75.
68. Craft N, Shostak Y, Carey M, Sawyers CL. A mechanism for hormone-independent prostate cancer through modulation of androgen receptor signaling by the HER-2/neu tyrosine kinase. *Nat Med.* Mar 1999;5(3):280-5.
69. Qiu Y, Ravi L, Kung HJ. Requirement of ErbB2 for signalling by interleukin-6 in prostate carcinoma cells. *Nature.* May 7 1998;393(6680):83-5.
70. Nelson EC, Evans CP, Mack PC, Devere-White RW, Lara PN, Jr. Inhibition of Akt pathways in the treatment of prostate cancer. *Prostate Cancer Prostatic Dis.* 2007;10(4):331-9.
71. Coffey K, Robson CN. Regulation of the androgen receptor by post-translational modifications. *J Endocrinol.* Nov 2012;215(2):221-37.
72. Gareau JR, Lima CD. The SUMO pathway: emerging mechanisms that shape specificity, conjugation and recognition. *Nat Rev Mol Cell Biol.* Dec 2010;11(12):861-71.
73. Wilkinson KA, Henley JM. Mechanisms, regulation and consequences of protein SUMOylation. *Biochem J.* May 13 2010;428(2):133-45.
74. Poukka H, Karvonen U, Janne OA, Palvimo JJ. Covalent modification of the androgen receptor by small ubiquitin-like modifier 1 (SUMO-1). *Proc Natl Acad Sci U S A.* Dec 19 2000;97(26):14145-50.
75. Kaikkonen S, Jaaskelainen T, Karvonen U, Rytinki MM, Makkonen H, Gioeli D, et al. SUMO-specific protease 1 (SEN1) reverses the

hormone-augmented SUMOylation of androgen receptor and modulates gene responses in prostate cancer cells. *Mol Endocrinol*. Mar 2009;23(3):292-307.

76. Sutinen P, Malinen M, Heikkinen S, Palvimo JJ. SUMOylation modulates the transcriptional activity of androgen receptor in a target gene and pathway selective manner. *Nucleic Acids Res*. Jul 2014;42(13):8310-9.
77. Smith EP, Boyd J, Frank GR, Takahashi H, Cohen RM, Specker B, et al. Estrogen resistance caused by a mutation in the estrogen-receptor gene in a man. *N Engl J Med*. Oct 20 1994;331(16):1056-61.
78. Carani C, Qin K, Simoni M, Faustini-Fustini M, Serpente S, Boyd J, et al. Effect of testosterone and estradiol in a man with aromatase deficiency. *N Engl J Med*. Jul 10 1997;337(2):91-5.
79. Bilezikian JP, Morishima A, Bell J, Grumbach MM. Increased bone mass as a result of estrogen therapy in a man with aromatase deficiency. *N Engl J Med*. Aug 27 1998;339(9):599-603.
80. Bouillon R, Bex M, Vanderschueren D, Boonen S. Estrogens are essential for male pubertal periosteal bone expansion. *J Clin Endocrinol Metab*. Dec 2004;89(12):6025-9.
81. Merlotti D, Gennari L, Stolakis K, Nuti R. Aromatase activity and bone loss in men. *J Osteoporos*. 2011;2011:230671.
82. Lorentzon M, Swanson C, Andersson N, Mellstrom D, Ohlsson C. Free testosterone is a positive, whereas free estradiol is a negative, predictor of cortical bone size in young Swedish men: the GOOD study. *J Bone Miner Res*. Aug 2005;20(8):1334-41.
83. Finkelstein JS, Klibanski A, Neer RM, Greenspan SL, Rosenthal DI, Crowley WF, Jr. Osteoporosis in men with idiopathic hypogonadotropic hypogonadism. *Ann Intern Med*. Mar 1987;106(3):354-61.
84. Swartz CM, Young MA. Male hypogonadism and bone fracture. *N Engl J Med*. Apr 14 1988;318(15):996.
85. Slemenda CW, Longcope C, Zhou L, Hui SL, Peacock M, Johnston CC. Sex steroids and bone mass in older men. Positive associations with serum estrogens and negative associations with androgens. *J Clin Invest*. Oct 1 1997;100(7):1755-9.
86. Khosla S, Melton LJ, 3rd, Atkinson EJ, O'Fallon WM, Klee GG, Riggs BL. Relationship of serum sex steroid levels and bone turnover markers with bone mineral density in men and women: a key role for bioavailable estrogen. *J Clin Endocrinol Metab*. Jul 1998;83(7):2266-74.

87. Khosla S, Melton LJ, 3rd, Atkinson EJ, O'Fallon WM. Relationship of serum sex steroid levels to longitudinal changes in bone density in young versus elderly men. *J Clin Endocrinol Metab.* Aug 2001;86(8):3555-61.
88. Mellstrom D, Vandenput L, Mallmin H, Holmberg AH, Lorentzon M, Oden A, et al. Older men with low serum estradiol and high serum SHBG have an increased risk of fractures. *J Bone Miner Res.* Oct 2008;23(10):1552-60.
89. LeBlanc ES, Nielson CM, Marshall LM, Lapidus JA, Barrett-Connor E, Ensrud KE, et al. The effects of serum testosterone, estradiol, and sex hormone binding globulin levels on fracture risk in older men. *J Clin Endocrinol Metab.* Sep 2009;94(9):3337-46.
90. Vandenput L, Mellstrom D, Laughlin GA, Cawthon PM, Cauley JA, Hoffman AR, et al. Low Testosterone, but Not Estradiol, Is Associated With Incident Falls in Older Men: The International MrOS Study. *J Bone Miner Res.* Jun 2017;32(6):1174-81.
91. Mellstrom D, Johnell O, Ljunggren O, Eriksson AL, Lorentzon M, Mallmin H, et al. Free testosterone is an independent predictor of BMD and prevalent fractures in elderly men: MrOS Sweden. *J Bone Miner Res.* Apr 2006;21(4):529-35.
92. Woo J, Kwok T, Leung JC, Ohlsson C, Vandenput L, Leung PC. Sex steroids and bone health in older Chinese men. *Osteoporos Int.* May 2012;23(5):1553-62.
93. Orwoll E, Lambert LC, Marshall LM, Blank J, Barrett-Connor E, Cauley J, et al. Endogenous testosterone levels, physical performance, and fall risk in older men. *Arch Intern Med.* Oct 23 2006;166(19):2124-31.
94. Vanderschueren D, Laurent MR, Claessens F, Gielen E, Lagerquist MK, Vandenput L, et al. Sex steroid actions in male bone. *Endocr Rev.* Dec 2014;35(6):906-60.
95. Nilsson ME, Vandenput L, Tivesten A, Norlen AK, Lagerquist MK, Windahl SH, et al. Measurement of a Comprehensive Sex Steroid Profile in Rodent Serum by High-Sensitive Gas Chromatography-Tandem Mass Spectrometry. *Endocrinology.* Jul 2015;156(7):2492-502.
96. Wink CS, Felts WJ. Effects of castration on the bone structure of male rats: a model of osteoporosis. *Calcif Tissue Int.* 1980;32(1):77-82.
97. Vanderschueren D, Van Herck E, Suiker AM, Visser WJ, Schot LP, Bouillon R. Bone and mineral metabolism in aged male rats: short and long term effects of androgen deficiency. *Endocrinology.* May 1992;130(5):2906-16.

98. Turner RT, Hannon KS, Demers LM, Buchanan J, Bell NH. Differential effects of gonadal function on bone histomorphometry in male and female rats. *J Bone Miner Res.* Aug 1989;4(4):557-63.
99. Vandenput L, Swinnen JV, Boonen S, Van Herck E, Erben RG, Bouillon R, et al. Role of the androgen receptor in skeletal homeostasis: the androgen-resistant testicular feminized male mouse model. *J Bone Miner Res.* Sep 2004;19(9):1462-70.
100. Yeh S, Tsai MY, Xu Q, Mu XM, Lardy H, Huang KE, et al. Generation and characterization of androgen receptor knockout (ARKO) mice: an in vivo model for the study of androgen functions in selective tissues. *Proc Natl Acad Sci U S A.* Oct 15 2002;99(21):13498-503.
101. Notini AJ, McManus JF, Moore A, Bouxsein M, Jimenez M, Chiu WS, et al. Osteoblast deletion of exon 3 of the androgen receptor gene results in trabecular bone loss in adult male mice. *J Bone Miner Res.* Mar 2007;22(3):347-56.
102. Kawano H, Sato T, Yamada T, Matsumoto T, Sekine K, Watanabe T, et al. Suppressive function of androgen receptor in bone resorption. *Proc Natl Acad Sci U S A.* Aug 5 2003;100(16):9416-21.
103. Venken K, De Gendt K, Boonen S, Ophoff J, Bouillon R, Swinnen JV, et al. Relative impact of androgen and estrogen receptor activation in the effects of androgens on trabecular and cortical bone in growing male mice: a study in the androgen receptor knockout mouse model. *J Bone Miner Res.* Apr 2006;21(4):576-85.
104. MacLean HE, Chiu WS, Notini AJ, Axell AM, Davey RA, McManus JF, et al. Impaired skeletal muscle development and function in male, but not female, genomic androgen receptor knockout mice. *FASEB J.* Aug 2008;22(8):2676-89.
105. Callewaert F, Venken K, Ophoff J, De Gendt K, Torcasio A, van Lenthe GH, et al. Differential regulation of bone and body composition in male mice with combined inactivation of androgen and estrogen receptor-alpha. *FASEB J.* Jan 2009;23(1):232-40.
106. Chiang C, Chiu M, Moore AJ, Anderson PH, Ghasem-Zadeh A, McManus JF, et al. Mineralization and bone resorption are regulated by the androgen receptor in male mice. *J Bone Miner Res.* Apr 2009;24(4):621-31.
107. Sinnesael M, Claessens F, Laurent M, Dubois V, Boonen S, Deboel L, et al. Androgen receptor (AR) in osteocytes is important for the maintenance of male skeletal integrity: evidence from targeted AR disruption in mouse osteocytes. *J Bone Miner Res.* Dec 2012;27(12):2535-43.

108. Maatta JA, Buki KG, Ivaska KK, Nieminen-Pihala V, Elo TD, Kahkonen T, et al. Inactivation of the androgen receptor in bone-forming cells leads to trabecular bone loss in adult female mice. *Bonekey Rep.* 2013;2:440.
109. Huggins C, Stevens RE, Jr, Hodges CV. Studies on prostatic cancer: II. the effects of castration on advanced carcinoma of the prostate gland. *Archives of Surgery.* 1941;43(2):209-23.
110. Shahinian VB, Kuo YF, Freeman JL, Goodwin JS. Risk of fracture after androgen deprivation for prostate cancer. *N Engl J Med.* Jan 13 2005;352(2):154-64.
111. Schally AV, Kastin AJ, Arimura A. Hypothalamic follicle-stimulating hormone (FSH) and luteinizing hormone (LH)-regulating hormone: structure, physiology, and clinical studies. *Fertil Steril.* Nov 1971;22(11):703-21.
112. Seidenfeld J, Samson DJ, Hasselblad V, Aronson N, Albertsen PC, Bennett CL, et al. Single-therapy androgen suppression in men with advanced prostate cancer: a systematic review and meta-analysis. *Ann Intern Med.* Apr 4 2000;132(7):566-77.
113. Potter GA, Barrie SE, Jarman M, Rowlands MG. Novel steroidal inhibitors of human cytochrome P45017 alpha (17 alpha-hydroxylase-C17,20-lyase): potential agents for the treatment of prostatic cancer. *J Med Chem.* Jun 23 1995;38(13):2463-71.
114. de Bono JS, Logothetis CJ, Molina A, Fizazi K, North S, Chu L, et al. Abiraterone and increased survival in metastatic prostate cancer. *N Engl J Med.* May 26 2011;364(21):1995-2005.
115. Span PN, Voller MC, Smals AG, Sweep FG, Schalken JA, Feneley MR, et al. Selectivity of finasteride as an in vivo inhibitor of 5alpha-reductase isozyme enzymatic activity in the human prostate. *J Urol.* Jan 1999;161(1):332-7.
116. Karantanos T, Evans CP, Tombal B, Thompson TC, Montironi R, Isaacs WB. Understanding the mechanisms of androgen deprivation resistance in prostate cancer at the molecular level. *Eur Urol.* Mar 2015;67(3):470-9.
117. Gregory CW, Johnson RT, Jr., Mohler JL, French FS, Wilson EM. Androgen receptor stabilization in recurrent prostate cancer is associated with hypersensitivity to low androgen. *Cancer Res.* Apr 1 2001;61(7):2892-8.
118. Sack JS, Kish KF, Wang C, Attar RM, Kiefer SE, An Y, et al. Crystallographic structures of the ligand-binding domains of the androgen receptor and its T877A mutant complexed with the natural

- agonist dihydrotestosterone. *Proc Natl Acad Sci U S A*. Apr 24 2001;98(9):4904-9.
119. Suzuki H, Akakura K, Komiya A, Aida S, Akimoto S, Shimazaki J. Codon 877 mutation in the androgen receptor gene in advanced prostate cancer: relation to antiandrogen withdrawal syndrome. *Prostate*. Sep 1996;29(3):153-8.
 120. Tran C, Ouk S, Clegg NJ, Chen Y, Watson PA, Arora V, et al. Development of a second-generation antiandrogen for treatment of advanced prostate cancer. *Science*. May 8 2009;324(5928):787-90.
 121. Clegg NJ, Wongvipat J, Joseph JD, Tran C, Ouk S, Dilhas A, et al. ARN-509: a novel antiandrogen for prostate cancer treatment. *Cancer Res*. Mar 15 2012;72(6):1494-503.
 122. Beer TM, Armstrong AJ, Rathkopf DE, Loriot Y, Sternberg CN, Higano CS, et al. Enzalutamide in metastatic prostate cancer before chemotherapy. *N Engl J Med*. Jul 31 2014;371(5):424-33.
 123. Scher HI, Fizazi K, Saad F, Taplin ME, Sternberg CN, Miller K, et al. Increased survival with enzalutamide in prostate cancer after chemotherapy. *N Engl J Med*. Sep 27 2012;367(13):1187-97.
 124. U.S. Food and Drug Administration. (July 16, 2018). "FDA approves enzalutamide for castration-resistant prostate cancer." Retrieved November 14, 2018, from <https://www.fda.gov/drugs/informationondrugs/approveddrugs/ucm613543.htm>.
 125. Smith MR, Saad F, Chowdhury S, Oudard S, Hadaschik BA, Graff JN, et al. Apalutamide Treatment and Metastasis-free Survival in Prostate Cancer. *N Engl J Med*. Apr 12 2018;378(15):1408-18.
 126. Snyder PJ, Kopperdahl DL, Stephens-Shields AJ, Ellenberg SS, Cauley JA, Ensrud KE, et al. Effect of Testosterone Treatment on Volumetric Bone Density and Strength in Older Men With Low Testosterone: A Controlled Clinical Trial. *JAMA Intern Med*. Apr 1 2017;177(4):471-9.
 127. Bhasin S, Storer TW, Berman N, Yarasheski KE, Clevenger B, Phillips J, et al. Testosterone replacement increases fat-free mass and muscle size in hypogonadal men. *J Clin Endocrinol Metab*. Feb 1997;82(2):407-13.
 128. Snyder PJ, Peachey H, Berlin JA, Hannoush P, Haddad G, Dlewati A, et al. Effects of testosterone replacement in hypogonadal men. *J Clin Endocrinol Metab*. Aug 2000;85(8):2670-7.
 129. Narayanan R, Coss CC, Dalton JT. Development of selective androgen receptor modulators (SARMs). *Mol Cell Endocrinol*. Apr 15 2018;465:134-42.

130. Dalton JT, Mukherjee A, Zhu Z, Kirkovsky L, Miller DD. Discovery of nonsteroidal androgens. *Biochem Biophys Res Commun.* Mar 6 1998;244(1):1-4.
131. Kearbey JD, Gao W, Narayanan R, Fisher SJ, Wu D, Miller DD, et al. Selective Androgen Receptor Modulator (SARM) treatment prevents bone loss and reduces body fat in ovariectomized rats. *Pharm Res.* Feb 2007;24(2):328-35.
132. Sauer B. Functional expression of the cre-lox site-specific recombination system in the yeast *Saccharomyces cerevisiae*. *Mol Cell Biol.* Jun 1987;7(6):2087-96.
133. Gu H, Marth JD, Orban PC, Mossmann H, Rajewsky K. Deletion of a DNA polymerase beta gene segment in T cells using cell type-specific gene targeting. *Science.* Jul 1 1994;265(5168):103-6.
134. Sauer B, Henderson N. Site-specific DNA recombination in mammalian cells by the Cre recombinase of bacteriophage P1. *Proc Natl Acad Sci U S A.* Jul 1988;85(14):5166-70.
135. De Gendt K, Swinnen JV, Saunders PT, Schoonjans L, Dewerchin M, Devos A, et al. A Sertoli cell-selective knockout of the androgen receptor causes spermatogenic arrest in meiosis. *Proc Natl Acad Sci U S A.* Feb 3 2004;101(5):1327-32.
136. Rodda SJ, McMahon AP. Distinct roles for Hedgehog and canonical Wnt signaling in specification, differentiation and maintenance of osteoblast progenitors. *Development.* Aug 2006;133(16):3231-44.
137. Davey RA, Clarke MV, Sastra S, Skinner JP, Chiang C, Anderson PH, et al. Decreased body weight in young Osterix-Cre transgenic mice results in delayed cortical bone expansion and accrual. *Transgenic Res.* Aug 2012;21(4):885-93.
138. Mizoguchi T, Pinho S, Ahmed J, Kunisaki Y, Hanoun M, Mendelson A, et al. Osterix marks distinct waves of primitive and definitive stromal progenitors during bone marrow development. *Dev Cell.* May 12 2014;29(3):340-9.
139. Hayashi S, McMahon AP. Efficient Recombination in Diverse Tissues by a Tamoxifen-Inducible Form of Cre: A Tool for Temporally Regulated Gene Activation/Inactivation in the Mouse. *Developmental Biology.* 4/15/ 2002;244(2):305-18.
140. Manolagas SC, Kronenberg HM. Reproducibility of results in preclinical studies: a perspective from the bone field. *J Bone Miner Res.* Oct 2014;29(10):2131-40.
141. Jardí F, Laurent MR, Dubois V, Khalil R, Deboel L, Schollaert D, et al. A shortened tamoxifen induction scheme to induce CreER recombinase

- without side effects on the male mouse skeleton. *Molecular and Cellular Endocrinology*. 9/5/ 2017;452:57-63.
142. Perry MJ, Gujra S, Whitworth T, Tobias JH. Tamoxifen Stimulates Cancellous Bone Formation in Long Bones of Female Mice. *Endocrinology*. 2005;146(3):1060-5.
 143. Zhong ZA, Sun W, Chen H, Zhang H, Lay YA, Lane NE, et al. Optimizing tamoxifen-inducible Cre/loxP system to reduce tamoxifen effect on bone turnover in long bones of young mice. *Bone*. Dec 2015;81:614-9.
 144. Gioeli D, Paschal BM. Post-translational modification of the androgen receptor. *Mol Cell Endocrinol*. Apr 16 2012;352(1-2):70-8.
 145. Feldkamp LA, Goldstein SA, Parfitt AM, Jesion G, Kleerekoper M. The direct examination of three-dimensional bone architecture in vitro by computed tomography. *J Bone Miner Res*. Feb 1989;4(1):3-11.
 146. Martin-Badosa E, Amblard D, Nuzzo S, Elmoutaouakkil A, Vico L, Peyrin F. Excised bone structures in mice: imaging at three-dimensional synchrotron radiation micro CT. *Radiology*. Dec 2003;229(3):921-8.
 147. Turner CH, Burr DB. Basic biomechanical measurements of bone: a tutorial. *Bone*. Jul-Aug 1993;14(4):595-608.
 148. Higuchi R, Dollinger G, Walsh PS, Griffith R. Simultaneous amplification and detection of specific DNA sequences. *Biotechnology (N Y)*. Apr 1992;10(4):413-7.
 149. Marcus R, Leary D, Schneider DL, Shane E, Favus M, Quigley CA. The contribution of testosterone to skeletal development and maintenance: lessons from the androgen insensitivity syndrome. *J Clin Endocrinol Metab*. Mar 2000;85(3):1032-7.
 150. Long F. Building strong bones: molecular regulation of the osteoblast lineage. *Nat Rev Mol Cell Biol*. Dec 22 2011;13(1):27-38.
 151. Nakashima K, Zhou X, Kunkel G, Zhang Z, Deng JM, Behringer RR, et al. The novel zinc finger-containing transcription factor osterix is required for osteoblast differentiation and bone formation. *Cell*. Jan 11 2002;108(1):17-29.
 152. Ucer S, Iyer S, Bartell SM, Martin-Millan M, Han L, Kim HN, et al. The Effects of Androgens on Murine Cortical Bone Do Not Require AR or ER α Signaling in Osteoblasts and Osteoclasts. *J Bone Miner Res*. Jul 2015;30(7):1138-49.
 153. Logan M, Martin JF, Nagy A, Lobe C, Olson EN, Tabin CJ. Expression of Cre Recombinase in the developing mouse limb bud driven by a Prxl enhancer. *Genesis*. Jun 2002;33(2):77-80.

154. Sinnesael M, Jardi F, Deboel L, Laurent MR, Dubois V, Zajac JD, et al. The androgen receptor has no direct antiresorptive actions in mouse osteoclasts. *Mol Cell Endocrinol.* Aug 15 2015;411:198-206.
155. Ducy P, Schinke T, Karsenty G. The osteoblast: a sophisticated fibroblast under central surveillance. *Science.* Sep 1 2000;289(5484):1501-4.
156. Roggia C, Gao Y, Cenci S, Weitzmann MN, Toraldo G, Isaia G, et al. Up-regulation of TNF-producing T cells in the bone marrow: a key mechanism by which estrogen deficiency induces bone loss in vivo. *Proc Natl Acad Sci U S A.* Nov 20 2001;98(24):13960-5.
157. Bray F, Ferlay J, Soerjomataram I, Siegel RL, Torre LA, Jemal A. Global cancer statistics 2018: GLOBOCAN estimates of incidence and mortality worldwide for 36 cancers in 185 countries. *CA Cancer J Clin.* Sep 12 2018.
158. Merseburger AS, Haas GP, von Klot CA. An update on enzalutamide in the treatment of prostate cancer. *Ther Adv Urol.* Feb 2015;7(1):9-21.
159. Guerrero J, Alfaro IE, Gomez F, Protter AA, Bernales S. Enzalutamide, an androgen receptor signaling inhibitor, induces tumor regression in a mouse model of castration-resistant prostate cancer. *Prostate.* Sep 2013;73(12):1291-305.
160. Vidal O, Lindberg MK, Hollberg K, Baylink DJ, Andersson G, Lubahn DB, et al. Estrogen receptor specificity in the regulation of skeletal growth and maturation in male mice. *Proc Natl Acad Sci U S A.* May 9 2000;97(10):5474-9.
161. Tombal B, Borre M, Rathenborg P, Werbrouck P, Van Poppel H, Heidenreich A, et al. Long-Term Antitumor Activity and Safety of Enzalutamide Monotherapy in Hormone Naive Prostate Cancer: 3-Year Open Label Followup Results. *J Urol.* Feb 2018;199(2):459-64.
162. Hussain M, Fizazi K, Saad F, Rathenborg P, Shore N, Ferreira U, et al. Enzalutamide in Men with Nonmetastatic, Castration-Resistant Prostate Cancer. *N Engl J Med.* Jun 28 2018;378(26):2465-74.
163. Tombal B, Borre M, Rathenborg P, Werbrouck P, Van Poppel H, Heidenreich A, et al. Enzalutamide monotherapy in hormone-naive prostate cancer: primary analysis of an open-label, single-arm, phase 2 study. *Lancet Oncol.* May 2014;15(6):592-600.
164. Daniell HW, Dunn SR, Ferguson DW, Lomas G, Niazi Z, Stratte PT. Progressive osteoporosis during androgen deprivation therapy for prostate cancer. *J Urol.* Jan 2000;163(1):181-6.
165. Maillfert JF, Sibilias J, Michel F, Saussine C, Javier RM, Tavernier C. Bone mineral density in men treated with synthetic gonadotropin-

- releasing hormone agonists for prostatic carcinoma. *J Urol.* Apr 1999;161(4):1219-22.
166. Smith MR, McGovern FJ, Zietman AL, Fallon MA, Hayden DL, Schoenfeld DA, et al. Pamidronate to prevent bone loss during androgen-deprivation therapy for prostate cancer. *N Engl J Med.* Sep 27 2001;345(13):948-55.
 167. Liu PY, Death AK, Handelsman DJ. Androgens and cardiovascular disease. *Endocr Rev.* Jun 2003;24(3):313-40.
 168. Kuhn R, Schwenk F, Aguet M, Rajewsky K. Inducible gene targeting in mice. *Science.* Sep 8 1995;269(5229):1427-9.
 169. Bujard H. Controlling genes with tetracyclines. *J Gene Med.* Sep-Oct 1999;1(5):372-4.
 170. Feil R, Brocard J, Mascrez B, LeMeur M, Metzger D, Chambon P. Ligand-activated site-specific recombination in mice. *Proc Natl Acad Sci U S A.* Oct 1 1996;93(20):10887-90.
 171. Almeida M, Laurent MR, Dubois V, Claessens F, O'Brien CA, Bouillon R, et al. Estrogens and Androgens in Skeletal Physiology and Pathophysiology. *Physiol Rev.* Jan 2017;97(1):135-87.
 172. Borjesson AE, Lagerquist MK, Liu C, Shao R, Windahl SH, Karlsson C, et al. The role of estrogen receptor alpha in growth plate cartilage for longitudinal bone growth. *J Bone Miner Res.* Dec 2010;25(12):2690-700.
 173. Borjesson AE, Windahl SH, Karimian E, Eriksson EE, Lagerquist MK, Engdahl C, et al. The role of estrogen receptor-alpha and its activation function-1 for growth plate closure in female mice. *Am J Physiol Endocrinol Metab.* Jun 01 2012;302(11):E1381-9.
 174. Morishima A, Grumbach MM, Simpson ER, Fisher C, Qin K. Aromatase deficiency in male and female siblings caused by a novel mutation and the physiological role of estrogens. *J Clin Endocrinol Metab.* Dec 1995;80(12):3689-98.
 175. Grossmann M. Low testosterone in men with type 2 diabetes: significance and treatment. *J Clin Endocrinol Metab.* Aug 2011;96(8):2341-53.
 176. Sato T, Matsumoto T, Yamada T, Watanabe T, Kawano H, Kato S. Late onset of obesity in male androgen receptor-deficient (AR KO) mice. *Biochem Biophys Res Commun.* Jan 3 2003;300(1):167-71.
 177. McCall P, Adams CE, Willder JM, Bennett L, Qayyum T, Orange C, et al. Androgen receptor phosphorylation at serine 308 and serine 791

- predicts enhanced survival in castrate resistant prostate cancer patients. *Int J Mol Sci.* Aug 13 2013;14(8):16656-71.
178. Willder JM, Heng SJ, McCall P, Adams CE, Tannahill C, Fyffe G, et al. Androgen receptor phosphorylation at serine 515 by Cdk1 predicts biochemical relapse in prostate cancer patients. *Br J Cancer.* Jan 15 2013;108(1):139-48.
179. Patek S, Willder J, Heng J, Taylor B, Horgan P, Leung H, et al. Androgen receptor phosphorylation status at serine 578 predicts poor outcome in prostate cancer patients. *Oncotarget.* Jan 17 2017;8(3):4875-87.
180. DePaolo JS, Wang Z, Guo J, Zhang G, Qian C, Zhang H, et al. Acetylation of androgen receptor by ARD1 promotes dissociation from HSP90 complex and prostate tumorigenesis. *Oncotarget.* Nov 1 2016;7(44):71417-28.
181. Fu M, Rao M, Wang C, Sakamaki T, Wang J, Di Vizio D, et al. Acetylation of androgen receptor enhances coactivator binding and promotes prostate cancer cell growth. *Mol Cell Biol.* Dec 2003;23(23):8563-75.
182. Gustafsson KL, Farman H, Henning P, Lionikaite V, Moverare-Skrtic S, Wu J, et al. The role of membrane ERalpha signaling in bone and other major estrogen responsive tissues. *Sci Rep.* Jul 8 2016;6:29473.
183. Vinel A, Hay E, Valera MC, Buscato M, Adlanmerini M, Guillaume M, et al. Role of ERalphaMISS in the Effect of Estradiol on Cancellous and Cortical Femoral Bone in Growing Female Mice. *Endocrinology.* Jun 2016;157(6):2533-44.
184. Shih HM, Chang CC, Kuo HY, Lin DY. Daxx mediates SUMO-dependent transcriptional control and subnuclear compartmentalization. *Biochem Soc Trans.* Dec 2007;35(Pt 6):1397-400.