

# Next Generation Sequencing for Measurable Residual Disease Detection in Acute Myeloid Leukemia

Erik Delsing Malmberg

Department of Laboratory Medicine  
Institute of Biomedicine  
Sahlgrenska Academy, University of Gothenburg  
Gothenburg 2019



UNIVERSITY OF GOTHENBURG

Cover illustration:

Acute monoblastic leukemia. Photography courtesy of Benmärgslab, Department of Clinical Chemistry, Sahlgrenska University Hospital, Gothenburg - modified by author.

**Next Generation Sequencing for Measurable Residual Disease Detection  
in Acute Myeloid Leukemia**

© Erik Delsing Malmberg 2019

[erik.malmberg@gu.se](mailto:erik.malmberg@gu.se)

All reprints with permission from publishers.

ISBN 978-91-7833-462-9 (PRINT)

ISBN 978-91-7833-463-6 (PDF)

<http://hdl.handle.net/2077/60780>

Printed in Gothenburg, Sweden 2019

Printed by BrandFactory AB

For Christine, my beloved wife

*DNA neither cares nor knows. DNA just is.  
And we dance to its music.*

-Richard Dawkins



# Next Generation Sequencing for Measurable Residual Disease Detection in Acute Myeloid Leukemia

Erik Delsing Malmberg

Department of Laboratory Medicine, Institute of Biomedicine  
Sahlgrenska Academy, University of Gothenburg  
Gothenburg, Sweden

## ABSTRACT

Acute myeloid leukemia (AML) is the most common form of acute leukemia and generally associated with a poor prognosis. For both children and adults, the treatment is based on chemotherapy. Allogeneic hematopoietic stem cell transplant (alloHCT) is reserved for patients with intermediate or high risk of relapse, due to its associated risks. The initial response to treatment is a very important prognostic factor. The response is determined by the amount of residual leukemic cells in the bone marrow during treatment – measurable residual disease (MRD). The methods currently used for MRD analysis have drawbacks in terms of sensitivity and/or applicability. The work included in this thesis focused on the development, validation and investigation of the clinical applicability of a next generation sequencing based strategy for MRD analysis. The strategy was based on identification of leukemia-specific mutations, present at diagnosis and suitable for MRD, using exome sequencing. These mutations were subsequently quantified in follow-up samples using an amplicon based sequencing method, targeted deep sequencing. The study samples comprised of blood and bone marrow collected at diagnosis, during follow-up, and at relapse from adults and children with AML. As proof-of-principle, we showed in paper I that exome-sequencing could be used for identification of leukemia-specific mutations at diagnosis and that targeted deep sequencing of these mutations in follow-up samples could be used for patient-tailored MRD analysis. Paper II showed that targeted deep sequencing of single nucleotide variations (SNVs) for patient-tailored MRD analysis was accurate with good reproducibility and sensitivity meeting the consensus criterion for molecular MRD analysis (<0.1% leukemic cells). Paper III showed that measurable levels of recurrent *NPM1* insertions after alloHCT, analyzed with targeted deep sequencing were associated with higher risk of relapse and worse overall survival as compared to non-detectable levels. Paper IV showed that targeted deep sequencing of SNVs for patient-tailored MRD analysis in peripheral blood could detect increasing mutation burden before hematological relapse in children. In conclusion, the results show that targeted deep sequencing of leukemia-specific mutations is an applicable tool for MRD analysis, enabling molecular surveillance for virtually all AML patients. The method could provide better support for treatment decisions and thereby chances for improved prognosis in AML.

**Keywords:** Acute Myeloid Leukemia, Minimal Residual Disease, Massively Parallel Sequencing, Next Generation Sequencing, *NPM1*, alloHCT

# SAMMANFATTNING

Akut myeloisk leukemi (AML) är den vanligaste formen av akut leukemi och drabbar årligen cirka 50 personer i Västra Götalandsregionen, varav ungefär en tiondel är barn. Prognosen är oftast dålig, där femårs-överlevnaden för vuxna som insjuknar i medianåldern (72år) är cirka 45%. Hos barn är AML mindre vanligt förekommande, men är den form av leukemi som har sämst prognos med en återfallsfrekvens på cirka 40% och total överlevnad på 70%. Hos både barn och vuxna bygger behandlingen på cytostatika. Endast patienter som bedöms ha en överhängande risk för återfall behandlas med efterföljande benmärgstransplantation. Detta eftersom benmärgstransplantation är förenad med en väsentlig risk för behandlingsrelaterad död och sena biverkningar. Patientens svar på den initiala behandlingen är en viktig faktor i beslut om denna behandling. Flödescytometri är den metod som huvudsakligen används för påvisande av små mängder kvarvarande leukemiceller, Measurable Residual Disease - MRD. Kvantitativ PCR kan användas för den andel AML patienter som har vanliga genetiska avvikelser och för vilka en analysmetod finns tillgänglig. Båda dessa metoder har nackdelar som gör att de inte går att använda för alla patienter.

I detta avhandlingsarbete har vi därför utvecklat, optimerat och testat den kliniska användbarheten av en metod för patient-specifik analys av MRD, baserad på nya generationens sekvenseringsteknik. I prov från diagnostillfället användes flödescytometri för att sortera patienteras leukemiceller från friska blodceller. Sedan analyserades arvsmassan från de sjuka respektive de friska cellerna separat med exomsekvensering. På detta sätt kunde mutationer som var specifika för varje patients leukemiceller identifieras. Utvalda mutationer användes sedan som markörer för att analysera kvarvarande mängder leukemiceller i uppföljningsprov med en metod som kallas riktad djupsekvensering. Vid riktad djupsekvensering kan förekomst av en specifik mutation i ett prov undersökas med hög känslighet. I delarbete I visade vi att leukemi-specifika mutationer kan identifieras med exomsekvensering i majoriteten av AML-fall vid diagnos och att dessa mutationer kan användas för skräddarsydd analys av MRD. I delarbete II visade vi att metoden har god riktighet och precision. Metoden användes för analys av benmärgsprov från patienter med AML under behandling och gav överensstämmande resultat, med högre känslighet än för MRD-analys utförd med flödescytometri. För benmärgsprov med MRD-nivåer  $>0,1\%$  kunde mutationerna även påvisas i blodprov tagna vid samma tillfälle. I delarbete III visade vi att påvisande av muterad *NPM1*-gen med riktad djupsekvensering hos AML patienter som genomgått benmärgstransplantation, är associerat

med högre risk för återfall och sämre överlevnad. Detta samband var oberoende av andra kända riskfaktorer. I delarbete IV kunde vi påvisa leukemi-specifika punktmutationer i blod hos majoriteten av barn som genomgått behandling för AML innan kliniskt återfall. Tidig upptäckt av återfall skulle kunna leda till bättre respons på insatt behandling och förbättrad överlevnad.

Sammanfattningsvis ger metoden möjlighet till analys av behandlingsvar och monitorering för patienter med AML som idag inte kan följas med konventionella metoder.





# LIST OF PAPERS

This thesis is based on the following studies, referred to in the text by their Roman numerals.

- I. **Malmberg E. B.R.**, Ståhlman S., Rehammar A., Samuelsson T., J. Alm S., Kristiansson E., Abrahamsson J., Garelius H., Pettersson L., Ehinger M., Palmqvist L. and Fogelstrand L. Patient-tailored analysis of minimal residual disease in acute myeloid leukemia using next-generation sequencing.  
*European Journal of Haematology* 2017 Jan;98(1):26-37.
- II. **Delsing Malmberg E.**, Rehammar A., Buongermino Pereira M., Abrahamsson J., Samuelsson T., Ståhlman S., Asp J., Tierens A., Palmqvist L., Kristiansson E., and Fogelstrand L. Accurate and sensitive analysis of minimal residual disease in acute myeloid leukemia using deep sequencing of single nucleotide variations.  
*The Journal of Molecular Diagnostics* 2019 Jan;21(1):149-162.
- III. **Delsing Malmberg E.**, J. Alm S., Nicklasson M., Ståhlman S., Samuelsson T., Lazarevic V., Lenhoff S., Asp J., Ehinger M., Palmqvist L., Brune M., and Fogelstrand L. Minimal residual disease assessed with deep sequencing predicts relapse after allogeneic stem cell transplant in AML.  
*Leukemia & Lymphoma* 2019 Feb;60(2):409-417.
- IV. Løvvik Juul-Dam K.\*, **Delsing Malmberg E.\***, Rehammar A., Kristiansson E., Abrahamsson J., Aggerholm A., Maria Dirdal M., Jahnukainen K., Lausen B., Beier Ommen H., Hasle H.† and Fogelstrand L.† Patient-tailored deep sequencing of blood enables early detection of relapse in childhood acute myeloid leukemia. \*First authors contributed equally. † Senior authors contributed equally.  
*Manuscript*.

# CONTENT

ABBREVIATIONS .....	V
1 INTRODUCTION.....	1
1.1 DNA, mutations & malignant transformation.....	1
1.1.1 The DNA helix.....	1
1.1.2 Mutations – alterations in the DNA sequence.....	2
1.1.3 Malignant transformation.....	4
1.1.4 Next Generation Sequencing.....	4
1.2 Acute myeloid leukemia (AML) & leukemogenesis.....	6
1.2.1 AML epidemiology.....	6
1.2.2 Normal hematopoiesis & AML pathology.....	6
1.3 Diagnosis of AML.....	10
1.4 Recurrent genetic aberrations in AML & pattern of mutation acquisition.....	12
1.5 Risk stratification & treatment in AML.....	17
1.5.1 Treatment.....	17
1.5.2 Risk stratification in adult AML.....	18
1.5.3 Risk stratification in childhood AML.....	21
1.6 Minimal (or Measurable) residual disease.....	22
1.6.1 Definition & importance.....	22
1.6.2 Established methods for analysis of residual disease.....	23
1.6.5 The predictive role of MRD on outcome.....	25
1.6.8 MRD directed therapy in AML.....	27
1.7 Heterogeneity & evolution of leukemic cells.....	30
1.7.1 Immunophenotypic shifts in MFC-MRD.....	30
1.7.2 Genetic heterogeneity of leukemic cells, clonal evolution & clonal hematopoiesis.....	30
1.7.6 AML relapse.....	33
2 AIM.....	35
2.1 Specific aims.....	35

3	METHODOLOGICAL CONSIDERATIONS .....	37
3.1	Patient samples.....	37
3.1.1	Papers I & II .....	37
3.1.2	Paper III.....	37
3.1.3	Paper IV.....	37
3.2	Fluorescence activated cell sorting (FACS).....	38
3.3	Next generation sequencing .....	39
3.3.1	Exome sequencing.....	40
3.3.2	Choosing mutations suitable for MRD-analysis.....	40
3.3.3	Targeted deep sequencing .....	42
3.4	Sanger sequencing.....	44
3.5	Molecular chimerism .....	44
4	RESULTS .....	45
4.1	Patient-tailored analysis of minimal residual disease in acute myeloid leukemia using next generation sequencing (Paper I) .....	45
4.2	Accurate and sensitive analysis of minimal residual disease in acute myeloid leukemia using deep sequencing of single nucleotide variations (Paper II).....	47
4.3	Minimal residual disease assessed with deep sequencing predicts relapse after allogeneic stem cell transplant in AML (Paper III).....	49
4.4	Patient-tailored deep sequencing of blood enables early detection of relapse in childhood acute myeloid leukemia (Paper IV).....	51
5	DISCUSSION .....	53
5.1	Challenges of MRD testing in AML .....	53
5.2	What are we measuring? .....	55
5.3	Identifying MRD suitable somatic mutations .....	56
5.4	Individualized MRD monitoring in AML.....	59
5.5	NGS – based MRD analyses in AML with mutated NPM1.....	60
5.6	ddPCR for analysis of MRD .....	61
5.7	MRD surveillance after end of treatment.....	62
6	CONCLUDING REMARKS & FUTURE PERSPECTIVES.....	64
	ACKNOWLEDGEMENTS .....	67

REFERENCES..... 71

# ABBREVIATIONS

ALL	Acute lymphoblastic leukemia
AlloHCT	Allogeneic hematopoietic stem cell transplant
AML	Acute myeloid leukemia
APL	Acute promyelocytic leukemia
ASO-PCR	Allele-specific oligonucleotide PCR
AutoHCT	Autologous hematopoietic stem cell transplant
cDNA	Complementary DNA
CBF-AML	Core binding factor AML
CHIP	Clonal hematopoiesis of indeterminate potential
CI	Confidence interval
CIR	Cumulative incidence of relapse
CML	Chronic myelogenous leukemia
CN-AML	Cytogenetically normal acute myeloid leukemia
CR	Complete remission
CR1	First complete remission
CR2	Second complete remission
CV	Coefficient of variation
ddPCR	Droplet digital polymerase chain reaction
DLI	Donor lymphocyte infusion

DNA	Deoxyribonucleic acid
ELN	European LeukemiaNet
EFS	Event-free survival
FISH	Fluorescence in situ hybridization
FSC	Forward scatter
gDNA	Genomic DNA
GvHD	Graft-versus-host disease
GvL	Graft-versus-leukemia
HLA	Human leukocyte antigen
HSC	Hematopoietic stem cell
LAIP	Leukemia associated immunophenotype
LOD	Limit of detection
MDS	Myelodysplastic syndrome
MFC	Multiparameter flow cytometry
MMR	Major molecular response
MPN	Myeloproliferative neoplasm
MPS	Massively parallel sequencing
mRNA	Messenger RNA
MRD	Minimal/Measurable residual disease
NGS	Next generation sequencing
NOPHO	Nordic society of Paediatric Haematology and Oncology

OS	Overall survival
PCR	Polymerase chain reaction
RFS	Relapse-free survival
RNA	Ribonucleic acid
RT-qPCR	Reverse transcription quantitative polymerase chain reaction
SBS	Sequencing by synthesis
SNV	Single nucleotide variation
SSC	Side scatter
UMI	Unique molecular identifier
VAF	Variant allele frequency
VAF <sup>EC</sup>	Error corrected variant allele frequency
WES	Whole exome sequencing
WGS	Whole genome sequencing





# 1 INTRODUCTION

## 1.1 DNA, MUTATIONS & MALIGNANT TRANSFORMATION

*The capacity to blunder slightly is the real marvel of DNA. Without this special attribute, we would still be anaerobic bacteria and there would be no music.*

-Lewis Thomas,  
*The Lives of a Cell, 1974*

### 1.1.1 THE DNA HELIX

Nucleic acids, *i.e.* DNA or RNA, are essential components of all known life. Multicellular organisms, including human beings, carry a copy of the same DNA in almost all cells throughout the body. Residing within the nuclei of eukaryotic cells, DNA constitutes the blueprint for protein production and regulation. The DNA molecule consists of a sugar backbone and a sequence of four molecules, nucleotides: adenine (A), guanine (G), cytosine (C) and thymine (T) (*Figure 1*). Due to their chemical properties, adenine is always paired with thymine, and cytosine with guanine on the opposite strand. During the process of transcription, the DNA sequence is transcribed into single stranded messenger RNA (mRNA) which in turn is translated into a chain of amino acids in the cell cytoplasm. These chains of amino acids (*i.e.* proteins) execute a majority of the processes necessary for cell homeostasis. The DNA has secondary and tertiary structure forming chromatin and chromosomes. In total, the human genome consists of over 3 billion base pairs dispersed over 46 chromosomes, constituting approximately 20.000 protein-coding genes and additionally equally many non-coding genes (ensembl.org). A common definition of the gene is a sequence of DNA which codes for the production of a protein, isoforms of a protein or non-coding RNA (1).

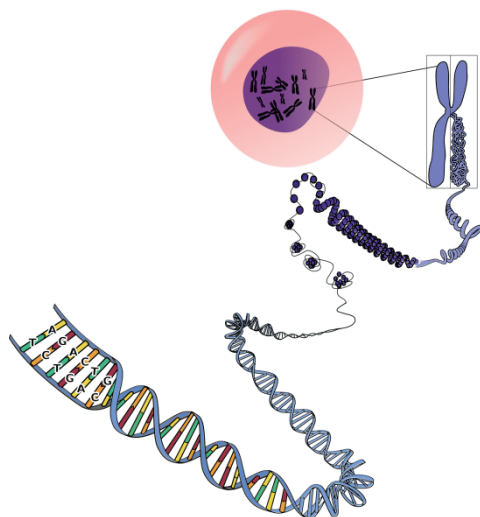

*Figure 1. Illustrated is the DNA-helix residing within the cell nucleus. The DNA is densely wrapped around proteins, forming chromatin, the constituent of our chromosomes. Image from OpenClipart-Vectors, Pixabay.*

### **1.1.2 MUTATIONS – ALTERATIONS IN THE DNA SEQUENCE**

The double stranded nature of the DNA helix allows copying, which is the fundamental basis for cell division and reproduction. At every cell division the DNA helix is duplicated through DNA replication, a truly marvelous endeavor. Error correction processes in the cell such as exonuclease activity of the DNA polymerase and mismatch repair, result in an error rate of one mistake in every  $10^9$  bases copied (2). Hence, copying errors are introduced in virtually every cell division. The DNA molecule is also exposed to insults from chemical reactions in the cell and potentially from external stimuli such as ionizing radiation and chemical mutagens, leading to alterations in the nucleotide sequence. The consequence of the alteration is dependent on mutation type, on where in the DNA sequence the mutation occurs and in what type of cell. A conversion from one nucleotide to another is referred to as a single nucleotide variation (SNV). If the SNV occurs in a protein coding sequence, possible outcomes at the protein level include truncation of the protein (nonsense mutation), exchange of one amino acid (missense mutation, classified as conservative if amino acid polarity is retained) or no change at

all in the chain of amino acids (silent mutation) (Figure 2A). Changes that are more dramatic can arise in the genome through insertions or deletions of several nucleotides. Unless the inserted or deleted sequence is a multiple of three, these mutations will cause a reading frameshift of the DNA code. Other major changes, recurrently involved in hematological malignancies, include translocations and inversions (Figure 2B). For example, the translocation of a proto-oncogene to a site with an adjacent active promoter results in increased expression of the oncogenic protein. Translocations could also lead to the creation of aberrant non-native proteins with oncogenic properties.

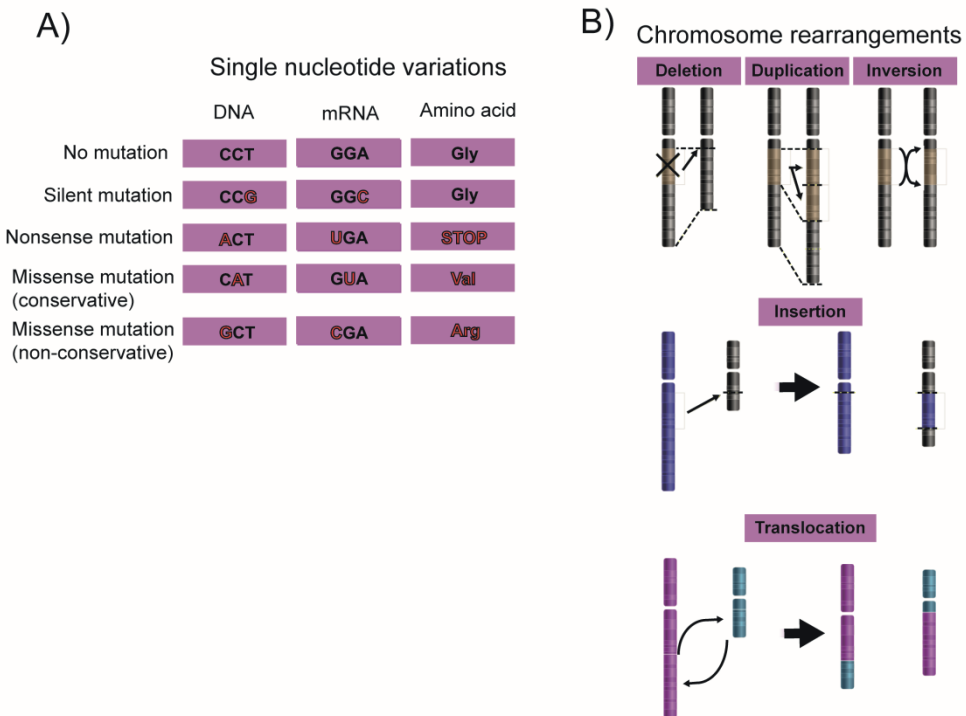

Figure 2. The different effects of a single nucleotide variation are exemplified in (A). Chromosomal rearrangements as depicted in (B) are recurrent events in neoplastic cells. Creator of (B) YassineMrabet, Wikimedia commons, Creative Commons CC0. Modified.

### 1.1.3 MALIGNANT TRANSFORMATION

Random mutations accumulate in our genomes throughout life due to replication errors during cell division and exposure to mutagens. Mutations in regions of the genome that govern cell proliferation, survival and apoptosis, so called proto-oncogenes and tumor suppressor genes, can eventually lead to the development of a neoplastic cell. Such a cell has acquired characteristic traits including, but not restricted to, independence from external signaling, resistance to programmed cell death, genome instability, infinite cell division and metastatic potential (3). This renegade cell will give rise to progeny that propagates without consideration of neighboring tissue. Some genes (and their respective gene product) have exceptional importance for counteracting neoplastic transformation. One such example is the tumor suppressor gene *TP53*, which is recurrently mutated to a certain degree in the majority of malignant diseases. A mutation leading to dysregulation of the normal DNA repair and pro-apoptotic response of *TP53* is a serious step toward malignant transformation. Other recurrent genetic lesions are more disease specific and can in fact be used as diagnostic criteria, *e.g.* the t(9;22)(q34;q11) reciprocal translocation in chronic myelogenous leukemia (CML). This translocation results in creation of the oncogenic BCR-ABL1 fusion protein, a constitutively active tyrosine kinase which accelerates cell proliferation.

The successive transformation from normal to neoplastic cell requires several mutations with activating effects on proto-oncogenes and inhibiting effects on tumor suppressor genes. Almost every case of malignant disease is unique in terms of its mutation profile, but mutations in certain genes and even in the same exact genomic positions are recurrent within each category of malignancies. The order in which these recurring mutations are acquired also seems to be of importance for the neoplastic process as similarities in mutation type acquisition order are found between cases of the same disease (for acute myeloid leukemia (AML) described later in section *Recurrent mutations in AML & pattern of mutation acquisition*).

### 1.1.4 NEXT GENERATION SEQUENCING

Next generation sequencing (NGS), sometimes referred to as Massively Parallel Sequencing (MPS), constitutes a number of different sequencing techniques where millions of DNA (or RNA) strands are sequenced separately and simultaneously. This is in contrast to Sanger sequencing where usually only one region of the genome can be sequenced at a time and the result is a consensus sequence. There are a number of different producers and platforms available for NGS, using different approaches for sequencing. This sequencing revolution has generated possibilities to sequence whole

exomes, genomes or transcriptomes in a single sequencing run, as well as the possibility to interrogate shorter genomic regions at very high resolution. In the surge of these high-throughput methods, databases collecting genomic data from different disease categories, *e.g.* for cancer genomes, have become important tools for scientists as larger genomic materials now can be studied. The NGS techniques have accelerated the identification of new mutated genes important in pathological processes as well as genes of prognostic importance.

Although used for research purposes during many years, the potential of NGS-based analyses for clinical use has now been widely recognized. Currently efforts are made to introduce different NGS assays for several clinical questions in Sweden, including hereditary diseases, microbiology and cancer diagnostics. For AML, a commercial targeted panel of 54 genes frequently mutated in myeloid malignancies is available for identification of prognostic markers and has been added as a recommended analysis in the 2018 Swedish national guidelines for treatment of AML.

## 1.2 ACUTE MYELOID LEUKEMIA (AML) & LEUKEMOGENESIS

*The pus corpuscles [...] were found in the blood throughout the system.*

-John Hughes Bennett,  
*Case of hypertrophy of the spleen and liver, which  
death took place from suppuration of the blood, 1845*

### 1.2.1 AML EPIDEMIOLOGY

AML is the most common form of acute leukemia in adults, with a worldwide incidence of 2.5 cases per 100,000 persons per year with a modest male predominance. The prognosis is generally poor, with the exception of the subtype acute promyelocytic leukemia (APL) which entails a good prognosis. Data from the Swedish Acute Leukemia Registry, including 2,767 patients diagnosed between years 1997-2005 (APL cases excluded), showed highest incidence of AML in ages 80-85 and a median age 72 years. At this age, the 5-year overall survival (OS) was 45% for patients fit for intense treatment (4). The corresponding 5-year OS for patients <50 years was 55%. AML constitutes approximately just 15-20% of all childhood leukemia cases but confers a worse prognosis compared to the more common acute lymphoblastic leukemia (ALL) (5). In a Nordic pediatric AML population, treated on the Nordic Society for Paediatric Haematology and Oncology (NOPHO) AML 2004 protocol, a 3-year OS of 69% was reported (6).

### 1.2.2 NORMAL HEMATOPOIESIS & AML PATHOLOGY

Blood has historically been viewed as the essence of life, and rightfully so. Our blood is full of specialized cells, carrying out essential functions such as oxygen transport, hemostasis and immune response. These cells have a short life span and billions of cells need to be replaced every day to maintain adequate levels. In the human adult, the blood production (hematopoiesis) occurs mainly in the bone marrow of the pelvis, sternum, vertebrae and cranium. In the current view of hematopoiesis, the hematopoietic stem cells (HSCs), from which all blood cells are derived, reside at the apex of the hematopoietic hierarchy. The HSCs have unlimited self-renewal capacity, meaning that they through cell division can give rise to new HSCs. The HSC

daughter cells can also evolve into committed progenitor cells, which in turn mature further into differentiated blood cells. Two of the earliest committed cells are the myeloid and lymphoid progenitor cells, from which all the myeloid and lymphoid cells are formed respectively (*Figure 3*). The mature myeloid cells consist of granulocytes (neutrophils, basophils and eosinophils) and monocytes as well as erythrocytes and thrombocytes. The differentiated cells of the lymphoid lineage constitute of small lymphocytes (B and T cells) and natural killer (NK) cells. The blood production is rigorously controlled by signal molecules; hormones or paracrine molecules, which drive cell division and differentiation. The morphological appearance of normal bone marrow is shown in *Figure 4, left panel*.

Hematological malignancies develop in the wake of deregulated hematopoiesis. The development of AML begins in a hematopoietic stem or progenitor cell of the myeloid lineage (*Figure 3*). By acquisition of mutations and subsequent malignant transformation, the cell undergoes clonal expansion. Although there seems to be a consensus that the ability for AML transformation is lost with differentiation, the cell of origin is yet to be determined for different types of AML. There are reports suggesting that the AML pathogenesis starts already at the level of self-renewing HSCs (7, 8). On the other hand, there is data showing the most immature hematopoietic cells are protected from leukemic transformation, at least for one specific AML subtype (9). The leukemic cells can have morphologic and immunophenotypic resemblances with any of the myeloid lineages in AML, but myeloblastic and monocytic characteristics are much more common than erythroid and megakaryoblastic features. The central attributes of the malignant cells are excess proliferation and block in differentiation, leading to the accumulation of abnormal immature leukocytes (blasts) primarily in bone marrow and blood (*Figure 4, right panel*). The accumulation of leukemic cells results in suppression of normal hematopoiesis (erythropenia, thrombocytopenia and neutropenia) and the following characteristic symptoms of acute leukemia: fatigue, bleeding and recurrent infections.

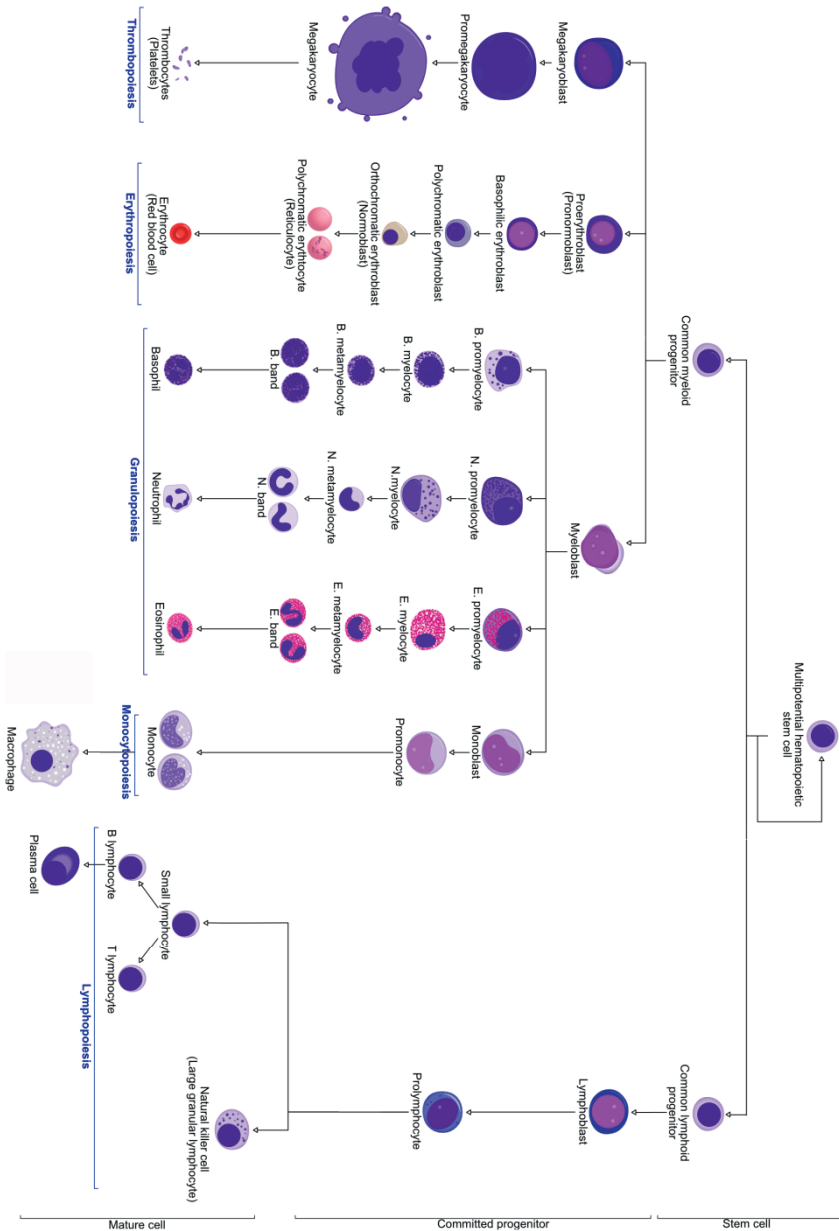
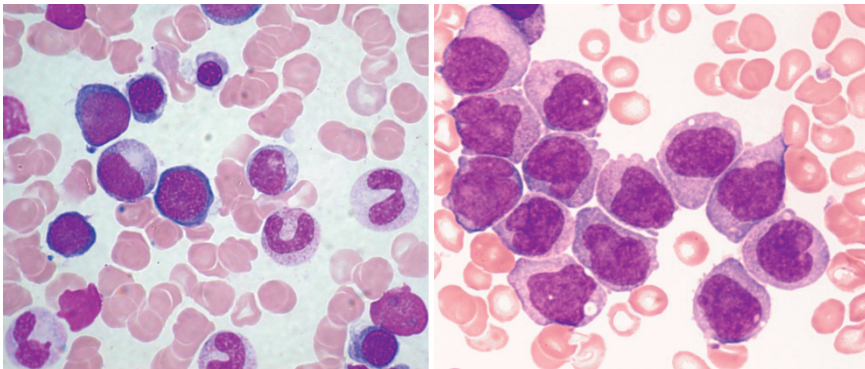

Figure 3. Illustration of the hierarchy of hematopoiesis. All hematopoietic cells are derived from hematopoietic stem cells. Creator A.Rad, Hematopoiesis (human) diagram, Wikimedia commons, Creative Commons BY-SA 3.0. Modified.



The majority of AML cases are so called *de novo* AML with a rapid onset of symptoms, without evidence of any obvious source of causation. Twenty-five percent of patients have a precedent hematological disease (myeloproliferative neoplasm (MPN) or myelodysplastic syndrome (MDS)) (4). AML development as a consequence of preceding MPN or MDS or chemotherapy treatment is often referred to as secondary AML. Other known risk factors, such as genetic disorders (*e.g.* Down's syndrome and Fanconi anemia), ionizing radiation, history of chemotherapy, and benzene exposure account for a minor fraction of all AML cases (5).



*Figure 4. Light microscopy of normal bone marrow (left panel) and Leukemic cells (blasts) in acute monoblastic leukemia (right panel). (Photographies courtesy of Benmärgslab, Department of Clinical Chemistry, Sahlgrenska University Hospital).*

## 1.3 DIAGNOSIS OF AML

During the diagnostic workup of suspected acute leukemia, numerous laboratory analyses are performed. Analysis of bone marrow morphology is used to determine relative cell numbers in a differential cell count and the morphological characteristics of the cells. To aid in the discrimination between AML and differential diagnoses, the leukemic cells are further characterized through cytochemical staining, and immunophenotyping using flow cytometry. Karyotyping and/or fluorescence *in situ* hybridization (FISH) are used to confirm or exclude the presence of chromosomal aberrations.

The criteria stated below are used to establish the diagnosis of AML.

### Criteria for AML diagnosis

- Leukemic cells (blasts) with myeloid, megakaryocytic or monocytic phenotype (or promonocytes) constitute  $\geq 20\%$  of nucleated cells in bone marrow or blood
- The first criteria does not have to be fulfilled if any of the AML-specific cytogenetic aberrations  $t(8;21)(q22;q22)$ ,  $inv(16)(p13q22)/t(16;16)(p13;q22)$  or  $t(15;17)(q22;q21)$  is present
- The presence of myeloid sarcoma is pathognomonic to AML, and the first criteria is not required to be fulfilled

The genetic heterogeneity of AML, and the resulting differences in risk of relapse, demands for sub-classification into separate disease entities. The outcome for patients lacking chromosomal aberrations (CN-AML) is also diverse. Therefore, in addition to the analyses outlined above, analyses of recurrent mutations in the genes *NPM1* and *CEBPA*, necessary for AML classification, are done through polymerase chain reaction (PCR) based assays. These analyses have recently been complemented with a broader mutation analysis using an NGS myeloid gene panel, including *RUNX1*, as AML with mutated *RUNX1* has received status of a provisional entity in the 2016 revision of the WHO classification of AML. Cases of AML are primarily classified according to the presence of recurrent cytogenetic or genetic aberrations as described in *Table 1*, whereas cases lacking these are classified according to their morphological appearance (AML, not otherwise

specified (NOS), *Table 1*). The AML NOS category corresponds to the previously used morphology-based French-American-British (FAB) classification of AML.

*Table 1. WHO Classification of Acute myeloid leukemia (AML) and related neoplasms (2016 revision) (10)*

<u>AML with recurrent genetic abnormalities</u>	<u>AML, NOS</u>
AML with t(8;21)(q22;q22); <i>RUNX1-RUNX1T1</i>	AML with minimal differentiation
AML with inv(16)(p13q22) or t(16;16)(p13;q22); <i>CBFB-MYH11</i>	AML without maturation
APL with t(15;17)(q22;q21); <i>PML-RARA</i>	AML with maturation
AML with t(9;11)(p21;q23); <i>MLLT3-KMT2A</i>	Acute myelomonocytic leukemia
AML with t(6;9)(p23;q34); <i>DEK-NUP214</i>	Acute monoblastic/monocytic leukemia
AML with inv(3)(q21q26) or t(3;3)(q21;q26); <i>GATA2- MECOM</i>	Pure erythroid leukemia
AML (megakaryoblastic) with t(1;22)(p13;q13); <i>RBM15-MKLI</i>	Acute megakaryoblastic leukemia
Provisional entity: AML with <i>BCR-ABL1</i>	Acute basophilic leukemia
AML with mutated <i>NPM1</i>	Acute panmyelosis with myelofibrosis
AML with biallelic mutations of <i>CEBPA</i>	<u>Myeloid sarcoma</u>
Provisional entity: AML with mutated <i>RUNX1</i>	<u>Myeloid proliferations related to Down syndrome</u>
<u>AML with myelodysplasia-related changes</u>	Transient abnormal myelopoiesis (TAM)
<u>Therapy-related myeloid neoplasms</u>	Myeloid leukemia associated with Down syndrome

## 1.4 RECURRENT GENETIC ABERRATIONS IN AML & PATTERN OF MUTATION ACQUISITION

AML is a heterogeneous disease entity. Through extensive genetic analyses it has been shown that adult AML genomes on average contain only 13 mutations in genes of which 5 recurrently mutated in AML (11). This suggests that AML genomes are less prone to genomic instability compared to most malignancies in adults (12). The mutational spectrum is different in adult and childhood AML. Chromosomal translocations, *e.g.* t(8;21) (*RUNX1-RUNX1T1*), inv(16) (*CBFB-MYH11*) and *KMT2A* rearrangements are more common in children (13) (*Figure 5A*). The chromosomal translocations correlate with age, where *KMT2A* rearrangements are found in infants and inv(16) (*CBFB-MYH11*) and t(8;21) (*RUNX1-RUNX1T1*) generally occur in older children (14). In addition to chromosomal translocations, specific gene mutations are also recurrent in AML. Mutations in *NPM1* and *FLT3* occur frequently and for *NPM1* more often in adults (15) (*Figure 5B*). Mutations in genes encoding epigenetic regulation, *e.g.* *DNMT3A* and *IDH1/2* are also common in adult AML but are rarely found in childhood AML. Some mutations have been described to be more common in childhood AML, including mutations in *NRAS* and *WT1*.

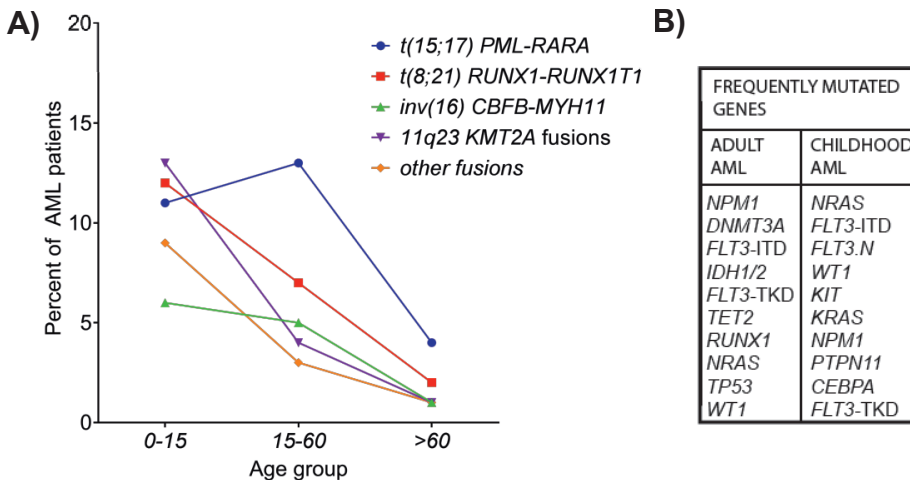

*Figure 5. The prevalence of recurrent chromosomal rearrangements among different age groups is shown in (A) and a list of the most frequently mutated genes in descending order is presented in (B). (Based on data from Grimwade & Freeman, Blood 2014 (13) and Bolouri et al., Nat. Med. 2018(15)).*

### 1.4.1 FUNCTIONAL GROUPING OF RECURRENT MUTATIONS

Due to the characteristic traits of increased proliferation and block in differentiation, a persisting view of AML leukemogenesis is the two-hit hypothesis proposed by Gilliland & Griffin (16). In this view, mutations belonging to two different categories (class I and II) with co-operating effects are needed for AML development. Class II mutations include mutations in genes encoding myeloid transcription factors with following impairment of hematopoietic differentiation (17). Class I mutations affecting tyrosine kinases and downstream pathways contribute to excess proliferation and evasion of apoptosis (*e.g. FLT3, KIT, KRAS, NRAS*). However, gene mutations in other pathways have also been shown to be of importance for AML development. One major group is the genes involved in epigenetic regulation, including mutations in genes encoding chromatin modifiers and genes involved in DNA methylation. Two other minor groups constitute mutations in cohesin complex and spliceosome genes. Spliceosome mutations seem to be related to myelodysplasia and are therefore found in AML secondary to MDS, but are also rather frequent in elderly with AML (18, 19). Mutations in the cohesin complex are quite uncommon and have a strong association to *NPM1* mutations. Interestingly mutations in the DNA methylation genes *IDH1, IDH2* and *TET2* occur in a mutually exclusive manner, which also is the case for mutations in cohesin complex and spliceosome genes as well as transcription factor fusions (11, 20-22). This implicates that several hits in the same pathway do not confer survival benefits. Genes involved in AML pathogenesis in adults are listed in *Table 2* and classified according to functional groups.

*Table 2. Genes involved in AML pathogenesis*

EPIGENETIC REGULATION		PROLIFERATION		DIFFERENTIATION			SPLICING	CELL DIVISION
DNA methylation (44%*)	Chromatin modifiers (30%*)	Activated signalling (59%*)	Tumor suppressors (16%*)	Myeloid transcription factors (22%*)	Transcription factor fusions (18%*)	<i>NPM1</i> (27%*)	Spliceosome (14%*)	Cohesin complex (13%*)
<i>DNMT3A/3B</i> <i>DNMT1</i> <i>IDH 1/2</i> <i>TET2</i>	<i>ASXL1</i> <i>EZH2</i> <i>KMT2A</i> -fusions <i>KMT2A-PTD</i> <i>KDM6A</i> <i>NUP98-NSD1</i> other modifiers	<i>FLT3</i> <i>KIT</i> <i>KRAS</i> <i>NRAS</i> serine/ threonine kinases	<i>PHF6</i> <i>TP53</i> <i>WT1</i>	<i>CEBPA</i> <i>RUNX1</i> other myeloid transcription factors	<i>CBFB-MYH11</i> <i>PML-RARA</i> <i>RUNX1-RUNX1T1</i>	<i>NPM1</i>	<i>U2AF</i> <i>SRSF2</i>	<i>SMC1/3</i> <i>STAG2</i> <i>RAD21</i>

\*Frequency in adult AML as reported by Ley *et al.*, *NEJM*, 2013 (11). Each AML case could have multiple genetic aberrations belonging to different functional groups.

Chromosomal rearrangements and mutations recurrent in AML that are central to this thesis are concisely described below.

#### 1.4.2 MUTATIONS IN NUCLEOPHOSMIN1 (*NPM1*)

Mutations in *NPM1* are among the most common genetic aberrations in AML, and occur in approximately 30% of adult AML and 7% of childhood AML (13). The *NPM1* gene, located on chromosome 5, encodes a phosphoprotein that normally exists in the cell nucleus where it has multiple functions, e.g. functions linked to DNA methylation, chromatin structure and regulation of the *ARF-p53* tumor suppressor pathway (23). The predominating mutations are the four base pair insertions type A (c.863\_864insTCTG, 80%), type B (c.863\_864insCATG, 9%) and type D (c.863\_864insCCTG, 3%), all resulting in the same frameshift (24). Frameshift mutations in *NPM1* exon 12 cause a modification in the protein's C-terminus, which elongates it and substitutes one or two tryptophan residues, leading to a translocation of the protein from the nucleus to the cytoplasm. The translocation causes a loss of the normal function of *NPM1* and is considered to contribute to leukemogenesis (25). The recurrent mutations in *NPM1* confer favorable risk, unless there is a concurrent *FLT3-ITD*.

#### 1.4.3 INTERNAL TANDEM DUPLICATIONS OF FMS-LIKE TYROSINE KINASE 3 (*FLT3-ITD*)

The prevalence of *FLT3-ITD* is also high in AML and is found in approximately 25% of cases (26). The *FLT3* gene encodes a receptor tyrosine kinase, present on hematopoietic stem and progenitor cells, which have a central role in the regulation of normal hematopoiesis (27). In-frame internal tandem duplications (ITDs) in this gene occur in the region coding for the juxtamembrane domain, and may vary from 3 to over 400bp in length. The ITD mutation leads to constitutive activation of the receptor, independent of the ligand (28). Presence of the mutation is associated with inferior outcome in both children and adults (29, 30). The allelic frequency of the *FLT3-ITD* is also reported to be important for prognosis. According to the 2017 ELN recommendations, patients with allelic ratio  $\geq 0.5$  should be stratified to adverse risk. Patients with mutated *NPM1* and an *FLT3-ITD* allelic ratio  $< 0.5$  should be considered to be at favorable risk. In the absence of a *NPM1* mutation, the presence of *FLT3-ITD* is associated with inferior outcome than for *FLT3* wildtype patients, regardless of allelic ratio (31). A recent study however reported the conflicting results that *NPM1* mutation and low allelic ratio was not associated with favorable outcome (32).

#### 1.4.4 *KMT2A* (11q23) FUSIONS

Translocations involving the *KMT2A* (*Lysine(K)-specific Methyl-Transferase 2A*, previously known as *MLL*) gene occur more often in childhood than adult AML. *KMT2A* rearranged AML is associated with monoblastic or myelomonocytic features (33). The *KMT2A* gene encodes a histone methyltransferase involved in epigenetic gene regulation during early development and hematopoiesis. A multitude of different fusion partners have been described, but only six are frequently found in AML of which *KMT2A-MLLT3* t(9;11)(p22;q23) is the most common (34). Translocation leads to deregulation of the *KMT2A* target genes (35). AML with *KMT2A* rearrangements are generally associated with poor prognosis and AML with *KMT2A* fusions seem to need fewer cooperating mutations than other AML-subgroups, suggesting a strong leukemogenic potential (11). A large study on pediatric AML confirmed that most *KMT2A*-rearrangements confer a poor prognosis, but also showed that the prognosis depends on the translocation partner (36).

#### 1.4.5 CORE BINDING FACTOR AML

Core binding factor (CBF) AML includes two recurrent cytogenetic aberrations; t(8;21)(q22;q22) *RUNX1-RUNX1T1* and inv(16)(p13q22)/t(16;16)(p13;q22) *CBFB-MYH11*. These translocations are also more frequent in childhood AML (18% of pediatric cases) than in adult AML (12% of adult cases), and identification of either of these two translocations is sufficient for diagnosis of AML (13). The core binding factors are transcriptional regulators consisting of two subunits, one alpha subunit which is DNA-binding and one beta subunit which is stabilizing. The beta subunit is encoded by *CBFB* and the alpha subunit by one of three different genes, of which one is *RUNX1*. The CBF dimer that is composed of *RUNX1* and *CBFB* is a transcriptional regulator of genes involved in myeloid differentiation (37). The *RUNX1-RUNX1T1* fusion protein exerts a dominant negative effect on the normal *RUNX1* protein (38). The *CBFB-MYH11* fusion protein forms filament, molecular high weight structures, which are thought to bind *RUNX1* and thereby prevent nuclear entrance (39). CBF AML is generally associated with a favorable prognosis.

#### 1.4.6 PATTERN OF MUTATION ACQUISITION

AML is genetically heterogeneous and hence the pattern of mutation acquisition is diverse. Two recent studies investigated the presence of somatic mutations in peripheral blood of healthy individuals who several years later developed AML (40, 41). This enabled identification of a premalignant mutational landscape, many years before diagnosis. One study

describes that individuals developing AML had more mutations and greater clonal complexity than age-matched controls (median 9.6 years before AML diagnosis). Mutations in genes *DNMT3A*, *IDH1*, *IDH2*, *TET2*, *TP53* and spliceosome genes were associated with increased risk of AML development, where all cases with *TP53*, *IDH1* and *IDH2* developed AML (40). Similarly, blood samples collected on average 6.3 years before AML diagnosis were analyzed in another study (41). Here it was reported that mutations in *DNMT3A*, *IDH2*, *TET2*, *TP53* and spliceosome genes (among others) were significantly enriched in cases that developed AML as compared to controls. Mutations in *TP53* and *U2AF* conferred a relatively high risk of AML development, whereas mutations in e.g. *DNMT3A* and *TET2* were associated with lower risk. No mutations in *NPM1* or any *FLT3*-ITDs were reported, in agreement with previous reports that mutations in these genes are late events in AML development (7, 8, 42), nor any mutations in *CEBPA*. These reports suggest that the stepwise evolution of AML occurs during a long period of time.

An earlier study showed that mutations in chromatin modifiers, genes involved in DNA methylation and cohesin complex genes as well as transcription factor fusions are early events in AML development compared to mutations in genes leading to activated signaling (7). *DNMT3A*-mutations have been reported to be retained in some patients who lost the *NPM1* mutation at relapse, suggesting that acquisition of *DNMT3A* mutations precede *NPM1* mutations (43). Several studies have further showed the persistence of *DNMT3A* and *IDH1/IDH2* mutations after treatment, suggesting that these mutations exist also in pre-leukemic cells (44-46).



## 1.5 RISK STRATIFICATION & TREATMENT IN AML

*He will manage the cure best who has foreseen what is to happen from the present state of matters.*

-Hippocrates

*The book of prognostics, Part 1, 400 BC.*

### 1.5.1 TREATMENT

The treatment protocols for both childhood and adult AML are based on chemotherapy (usually a combination of cytarabine and an anthracycline), administered in cycles. The first course/s (induction therapy) is/are given with the intent to induce complete remission (CR), *i.e.* morphologically normal bone marrow and restored peripheral blood cell counts.

Definition of complete remission (CR) according to the 2017 European LeukemiaNet (ELN) recommendations:

*Bone marrow blasts <5%, absence of circulating blasts and blasts with Auer rods, absence of extramedullary disease, absolute neutrophil count  $\geq 1.0 \times 10^9/L$ , platelet count  $\geq 100 \times 10^9/L$ , independence of red blood cell transfusions (47).*

The majority of patients under 60 years of age, 70-80%, enter CR from induction chemotherapy (48, 49). However, after achievement of CR additional treatment is needed to eradicate remaining leukemic cells (consolidation treatment) for prevention of early relapse. Adult patients at low risk of relapse obtain 2-3 consolidation courses of chemotherapy, whereas fit patients at intermediate or high risk of relapse are eligible for allogeneic hematopoietic stem cell transplant (alloHCT). Children with AML are stratified to standard or high risk and standard risk patients receive three courses of conventional chemotherapy after induction, whereas high risk

patients are assigned to alloHCT according to the NOPHO-DBH AML-2012 treatment protocol (Nordic Society of Paediatric Haematology and Oncology, EUdract number 2012-002934-35).

The aim of alloHCT is to eradicate the majority of all blood cells, including the malignant cells, using high-dose chemotherapy (conditioning) and thereafter restore the hematopoietic system. Patients undergoing alloHCT receive an intense conditioning therapy following a transfusion of hematopoietic stem cells from an HLA-matched sibling or unrelated donor, or in some instances a haplo-identical family member. Patients at low risk of relapse are not eligible for alloHCT as the intervention is associated with both direct (organ toxicity and increased risk of infections) and late onset complications (infertility and secondary malignancies) as well as a high mortality rate (50). In addition to the anti-leukemic effects of the chemotherapy administered as conditioning, the immunological response associated with alloHCT has potent effects. The donor cells (graft) attack the remaining leukemic cells through the Graft-versus-Leukemia (GvL) effect. This positive GvL effect can be further exploited through modulation of immunosuppressive drugs or by donor lymphocyte infusions (DLIs) after transplantation. Another consequence of alloHCT is the immunological response that occurs between the donor (graft) and recipient cells (host), causing the unwanted acute and sometimes chronic effects of Graft-versus-Host Disease (GvHD). In fulminant GvHD, the donor cells attack the host organs, causing painful immune-mediated mucositis, enteritis, skin rashes and potentially severe damage to liver and lungs. To reduce the risk of GvHD, the patient can be transplanted with T lymphocyte depleted donor cells. Other measures include administration of antithymocyte globulin (ATG) as a component of the conditioning regimen and post-transplant administration of potent immunosuppressive drugs.

### **1.5.2 RISK STRATIFICATION IN ADULT AML**

Risk stratification in AML is performed to identify groups of patients who differ in chance of achieving CR and risk of relapse after treatment. This in turn determines if the individual patient should be considered for treatment with alloHCT. There are numerous variables determining the risk of relapse for patients with AML. These can be divided into disease-related factors, such as genetic aberrations and treatment response, and patient-related factors such as age and comorbidity.

Risk stratification in adults with AML is primarily based on the prognostic implications of *genetic aberrations* detected at diagnosis (*Table 3*). Relapse risk in adult AML can also be predicted from the patient's *response to treatment*, independent of the genetic aberrations detected at diagnosis. Inefficient response to induction treatment (>15% blasts after course 1 or that >2 courses were needed to achieve remission) or presence of low amount of residual leukemic cells, minimal/measurable residual disease (MRD), during morphological CR are adverse risk factors (51-53). A history of antecedent hematological disease (MDS, MPN) or treatment with chemo- or radiotherapy not related to AML renders a higher risk of relapse as compared to *de novo* AML (54, 55). The frequencies of adverse risk cytogenetic aberrations are higher in these groups, but the risk of relapse varies based on cytogenetic aberrations similarly as for *de novo* AML (56). There is an increased incidence of unfavorable cytogenetic aberrations and antecedent hematological disorders in older patients. Age is however an important negative prognostic factor independent of cytogenetic aberrations, as treatment outcome declines with age in all subgroups in patients >50 years old (57, 58). Considering the dismal prognosis and the high mortality associated with alloHCT in the elderly, this treatment is seldom justified for patients > 70 years. Severe comorbidity with increasing prevalence in the elderly, *i.e.* heart, lung or kidney dysfunction, increases the risk of therapy related complications and early death. However, impaired performance status has been shown to negatively impact early death rate at all ages, and most patients < 80 years should be considered fit for standard intensity chemotherapy (4).

*Table 3. Adapt. from 2017 European LeukemiaNet risk stratification by genetics (47)*

<b>Risk category</b>	<b>Genetic abnormality</b>
<b>Favorable</b>	t(8;21)(q22;q22); <i>RUNX1-RUNX1T1</i> inv(16)(p13q22) or t(16;16)(p13;q22); <i>CBFB-MYH11</i> Mutated <i>NPM1</i> without <i>FLT3</i> -ITD or with <i>FLT3</i> <sup>low(a)</sup> Biallelic mutated <i>CEBPA</i>
<b>Intermediate</b>	Mutated <i>NPM1</i> and <i>FLT3-ITD</i> <sup>high(a)</sup> Wild-type <i>NPM1</i> without <i>FLT3</i> -ITD or with <i>FLT3</i> <sup>low(a)</sup> (w/o adverse-risk genetic lesion) t(9;11)(p21;q23); <i>MLLT3-KMT2A</i> <sup>(b)</sup> Cytogenetic abnormalities not classified as favorable or adverse
<b>Adverse</b>	inv(3)(q21q26) or t(3;3)(q21;q26); <i>GATA2-MECOM (EVII)</i> t(6;9)(p23;q34); <i>DEK-NUP214</i> t(v;11q23); <i>KMT2A</i> rearranged t(9;22)(q34;q11); <i>BCR-ABL1</i> -5q or del(5q); -7; -17/ abn(17p) Complex karyotype <sup>(c)</sup> , monosomal karyotype <sup>(d)</sup> Wild-type <i>NPM1</i> and <i>FLT3-ITD</i> <sup>high(a)</sup> Mutated <i>RUNX1</i> <sup>(e)</sup> Mutated <i>ASXL1</i> <sup>(e)</sup> Mutated <i>TP53</i>

<sup>a</sup>Low allelic ratio (<0.5); high allelic ratio (≥0.5).

<sup>b</sup>The presence of t(9;11)(p21;q23) takes precedence over rare, concurrent adverse-risk gene mutations.

<sup>c</sup>Three or more unrelated chromosome abnormalities in the absence of the WHO designated recurring translocations and inversions t(8;21), inv(16), t(16;16), t(v;11)(v;q23), t(6;9), inv(3), t(3;3) or t(9;22).

<sup>d</sup>Defined by the presence of one single monosomy (excluding loss of X and Y) in association with at least one additional monosomy or structural chromosome abnormality (excluding core binding factor AML).

<sup>e</sup>These markers should not be used as an adverse prognostic marker if they co-occur with favorable-risk AML subtypes.

### 1.5.3 RISK STRATIFICATION IN CHILDHOOD AML

Risk stratification according to the NOPHO-DBH AML-2012 treatment protocol, into standard or high risk of relapse, is based primarily on response to treatment evaluated with MRD. The only risk stratifying genetic aberration is *FLT3*-ITD without concurrent *NPM1* mutation (high risk), but the presence of *CBFB-MYH11* inv(16) also guides treatment intensity. Since few genetic aberrations have yet been shown to be of value for risk stratification, MRD is of even greater importance in children. MRD has been shown to be of prognostic value when used to evaluate treatment response after induction treatment using multiparameter flow cytometry (MFC), and the result from MFC-MRD therefore affects choice of treatment. To be noted, there are other genetic and cytogenetic aberrations shown to be of prognostic value in childhood AML, some of which are described in the WHO classification, that are used for risk stratification in other protocols. These include, among others, the favorable markers *NPM1* mutation, biallelic mutation in *CEBPA* and *RUNX1-RUNX1T1* t(8;21). Adverse marker include -7, -5(or del(5q)), *GATA2-MECOM* inv(3) and several *KMT2A* rearrangements (59).

## 1.6 MINIMAL (OR MEASURABLE) RESIDUAL DISEASE

*It is easy to make perfect decisions with perfect information. Medicine asks you to make perfect decisions with imperfect information.*

-Siddharta Mukherjee,  
*The Laws of Medicine: Field Notes from an  
Uncertain Science, 2015*

### 1.6.1 DEFINITION & IMPORTANCE

Historically, the only available method to determine treatment response was examination of bone marrow morphology with estimation of remaining leukemic cells using a light microscope. This method is associated with a number of limitations, including the intra-and inter-observer variability and that normally only five hundred nucleated cells are examined. Furthermore, healthy blasts which constitute a few percent of cells in normal bone marrow are difficult to separate morphologically from leukemic cells. Hence, leukemic cells less frequent than 1-5% cannot be detected using this method. As previously described, a majority of patients achieves CR after induction treatment, but this is not a sufficient reduction of the leukemic cells to prevent relapse. Morphological assessment of treatment response is thus not sensitive enough to detect small amounts of residual leukemic cells of clinical importance. Minimal residual disease is defined as residual leukemic cells detected during CR (*i.e.* levels below the resolution of light microscopy). This low percentage can still correspond to millions of leukemic cells spread throughout the body, and heralds the potential to give rise to relapse (*Figure 6*). As MRD negativity is not necessarily equivalent to absence of leukemic cells, the term measurable residual disease has been suggested to be more appropriate and is gaining acceptance. Sub-microscopic residual leukemic cells can now be quantified for prediction of outcome using immunophenotypic or molecular markers (60, 61). MRD can be assessed at early timepoints (post induction or consolidation treatment) to determine treatment response. According to the 2018 Swedish national guidelines for treatment of AML, patients who are MRD positive with favorable genetic risk should be considered for alloHCT in first remission (CR1). For MRD negative patients with intermediate genetic risk and comorbidity, alloHCT

could be abstained from. MRD status after alloHCT can be used to identify patients with increased relapse risk and therefore guide immunomodulatory treatment post-transplant. MRD surveillance can also be used after end of treatment for early detection of relapse.

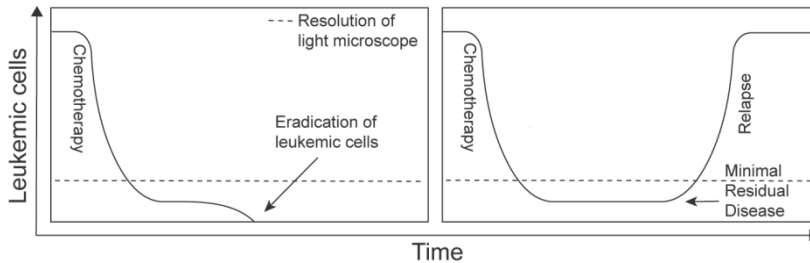

Figure 6. A schematic of the concept of minimal/measurable residual disease, which constitutes remaining leukemic cells after treatment below the resolution of the light microscope. The left panel illustrates a patient treated with chemotherapy achieving a successful eradication of the leukemic cells. The patient in the right panel has low levels of remnant leukemic cells after end of treatment, MRD, heralding a relapse.

## 1.6.2 ESTABLISHED METHODS FOR ANALYSIS OF RESIDUAL DISEASE

### 1.6.3 FLOW CYTOMETRY

Flow cytometry is used to measure the optical properties (size and complexity) and the protein expression characteristics of cells. To analyze protein expression, the cells of interest are labeled by the use of fluorochrome-conjugated antibodies targeting cell surface or cytoplasmic antigens. The flow cytometer identifies cells that express or lack the antigens of interest, when flowing through a single cell lane, using exciting light and fluorescence emission detectors. Most cytometers in clinical use have the capacity to synchronously analyze  $\geq 8$  fluorochromes. The ability to measure multiple antigens on each cell on thousands of cells per second, have made multi-parameter flow cytometry (MFC) important in characterization of hematological malignancies, including AML. To achieve comparable results between different laboratories, standardized flow cytometer settings, panels and protocols are needed. The EuroFlow consortium is one organization that develops guidelines to standardize workflows for 8-color flow cytometry between laboratories (62, 63).

In addition to having an important role in AML diagnostics, MFC is today the standard method for analysis of treatment response in AML (MFC-MRD). The method relies on the possibility to define a leukemia-associated immunophenotype (LAIP), distinguishable from normal bone marrow cells, to track during follow up. This is performed by identifying cells with abnormal patterns of immunophenotypic markers, including over- or under-expression of antigens, cross-lineage antigen expression and antigens with asynchronous expression. It is possible to identify a LAIP in approximately 90% of all AML cases (13). Alternatively, the Different-from-Normal approach can be used, where the MRD population/s is/are identified in MFC spaces normally empty in healthy controls. Using this strategy, identification of MRD populations during follow-up is not confined to the aberrant markers present at diagnosis. Thus, also markers affected by immunophenotypic shifts during treatment will be included. However, the lack of guidelines for how to define these empty spaces makes the method difficult to standardize. A commonly used cutoff for MRD positivity is 0.1% leukemic cells, as recommended by the ELN MRD Working Party (64). To be certain that an identified immunophenotypic population is true, it needs to constitute of a critical number of events. As the leukemic cells are quantified relative to other cells in the sample, the smallest cell population possible to determine MRD positive is dependent on the total number of analyzed cells. This limits the sensitivity of the method at times during treatment when the bone marrow is hypoplastic.

#### 1.6.4 RT-qPCR

Another method for MRD analysis is the reverse transcription quantitative polymerase chain reaction (RT-qPCR). Here, the expression of AML-specific genetic lesions relative to a stable reference gene is analyzed. Through conversion of mRNA to complementary DNA (cDNA), RT-qPCR is used for gene expression quantification by the use of an ordinary PCR in combination with a locus specific fluorescent probe or unspecific DNA stain. Residual leukemic cells can be quantified with higher sensitivity using this method than with MFC. The sensitivity of the assay depends on the relative expression of the fusion-gene in the leukemic cells as compared to the expression of a reference gene (e.g. *ABL1*). Hence, the sensitivity varies between different targets ( $\sim 10^{-3}$ - $10^{-6}$ ) and between patients. RT-qPCR for MRD analysis is only applicable to the subgroup of AML cases with recurrent chromosomal translocations, found in approximately 50% and 20% in childhood and adult AML respectively, such as *RUNX1-RUNX1T1* and *CBFB-MYH11* or recurrent mutations, such as *NPM1* (7% of children and 30% of adults) (13). In an effort to standardize the use of RT-qPCR assays



for MRD analysis in AML, the Europe Against Cancer network (EAC) has developed protocol recommendations regarding common Taqman probes, primers and reference genes (65).

## 1.6.5 THE PREDICTIVE ROLE OF MRD ON OUTCOME

### 1.6.6 HEMATOLOGICAL MALIGNANCIES BESIDES AML

The use of MRD for risk assessment and therapy modulation in AML, with the exception of APL, has been lagging behind the use in ALL and CML (66-68). For CML, MRD surveillance using RT-qPCR of *BCR-ABL1* transcripts are used to monitor treatment response at established time points and with set MRD cutoff levels guiding choice of therapy (67).

Regarding ALL, MRD has been shown to be the best predictor of relapse in both children and adults (69-73). Flow cytometry and allele-specific oligonucleotide (ASO) PCR are routinely applicable MRD methods. The ASO-PCR takes advantage of the fact that developing lymphocytes undergo genetic rearrangements in immunoglobulin (B cells) and T-cell receptor (T cells) genes and that ALL constitutes of a clonal expansion from a single lymphoid precursor cell. A randomized control trial (UKALL 2003) showed that treatment reduction based on low risk MRD status (measured by ASO-PCR, MRD cutoff  $10^{-4}$ ) at the end of induction therapy is possible for children and adolescents with ALL. The same study also investigated augmented therapy in MRD high-risk patients with significant effect on 5-year event-free survival (EFS), but with more adverse events (74). Eckert *et al.* focused on children with relapsed intermediate risk ALL. Patients with MRD levels  $\geq 10^{-3}$  (measured by ASO-PCR) at the end of induction therapy were allocated to alloHCT whereas those with MRD levels  $< 10^{-3}$  received chemotherapy. A significant increase in EFS was seen in the poor responder group as compared to the preceding protocol (75). In the NOPHO ALL2008 treatment protocol, MRD levels were used to risk stratify patients (age 1-45 years) using flow cytometry and ASO-PCR for BCP- and T-ALL respectively (76). Patients with residual disease  $\geq 5\%$  after induction and/or  $\geq 0.1\%$  after consolidation were eligible for alloHCT. They reported that the application of the more aggressive, MRD-guided, pediatric protocol on young adults resulted in a better outcome as compared to traditional treatment regimens for adults. Modvig *et al.* analyzed the results from the T-ALL patients in the NOPHO ALL2008 protocol where post-induction ASO-PCR MRD was used for risk stratification with cutoff 0.1% (77). MFC-MRD and ASO-PCR were run in parallel and for cases where no informative result was

obtainable from ASO-PCR, MFC-MRD was used for stratification. More than 99% of the patients had a marker for MRD assessment when combining the two methods. The negative predictive value was 92.2% for MFC-MRD and 95.8% for ASO-PCR for levels <0.1%.

### 1.6.7 AML

A considerable number of studies have shown the independent prognostic importance of MRD status on relapse risk and overall survival in AML using different methods and assessment time points.

It has been shown that MRD analysis of PML-RARA using RT-qPCR is a strong predictor of outcome in APL and that MRD guided preemptive therapy can prevent relapse (66). MRD positivity after consolidation treatment in APL is therefore used to determine eligibility for alloHCT. Further, in case of molecular relapse after end of treatment, early treatment intervention should be considered according to the current ELN recommendations (78).

MFC-MRD has shown to be of prognostic value when used to evaluate treatment response after induction treatment in both children and adults with AML (52, 60, 79, 80). Remission status as determined with MFC is a better predictor of outcome in AML than CR as determined with morphology (80-82). The result from MFC-MRD therefore affects the choice of treatment in several current treatment protocols (83, 84). The prognostic importance of MFC-MRD in adults has also been established pre- and post alloHCT (85-87).

Quantification of MRD using RT-qPCR of the genetic aberrations, *RUNX1-RUNX1T1*, *CBFB-MYH11*, *KMT2A-MLL3* and *NPM1*, during treatment has been shown to be predictive of outcome (61, 88-92). Regarding the alloHCT setting, post-transplant MRD-status determined with RT-qPCR of fusion transcripts *RUNX1-RUNX1T1* and *CBFB-MYH11* has been shown to confer prognostic significance (93, 94). Transcript expression levels of the gene Wilm's Tumor 1 (*WT1*) quantified by RT-qPCR have prognostic value when measured before and after alloHCT (95, 96). Finally, MRD analysis using RT-qPCR of mutated *NPM1* pre- and post-alloHCT has also been shown predictive of outcome (25, 97, 98). Although standardized RT-qPCR assays are available, MRD based decision making in AML using RT-qPCR has just recently been introduced in clinical practice. According to the recently published recommendations from the ELN MRD Working Party, molecular MRD analysis should be performed in adult patients with APL (*PML-RARA*), AML with *CBFB-MYH11* or *RUNX1-RUNX1T1* and *NPM1* mutated AML.

There are however no recommendations from ELN for change in therapy based on result. The remaining patients should be monitored with MFC-MRD. The use of *WT1* as MRD marker is not recommended if another method is available, due to low sensitivity and specificity (64). Recommendations regarding MRD analysis of *NPM1* and CBF-AML have in line with this been added to the 2018 Swedish national guidelines for treatment of AML.

### 1.6.8 MRD DIRECTED THERAPY IN AML

Whether MRD can be used for therapy modulation or preemptive treatment for prevention of relapse in AML is still under investigation. Large prospective randomized controlled trials showing that treatment interventions based on MRD status leads to improved outcome are still lacking.

### 1.6.9 THERAPY MODULATION

In childhood AML, a prospective study used risk stratification based on a combination of cytogenetic risk group and MFC-MRD (cutoff 0.1%) after the first course of chemotherapy to guide treatment intensification. High-risk patients were eligible for alloHCT, whereas low-risk patients received chemotherapy only. They compared their results to other recent trials and concluded that their strategy could improve outcome in childhood AML (83). The current Nordic treatment protocol for childhood AML (NOPHO-DBH AML-2012) has adopted this MRD cutoff after induction treatment for allocation to the high-risk group.

Another prospective, but not randomized, study investigated adult patients with *RUNX1-RUNX1T1*, where high-risk patients either failed to achieve major molecular response (MMR; defined as > 3-log reduction in fusion transcripts compared to pretreatment baseline) after the second consolidation treatment or lost MMR status within 6 months. Low risk-patients achieved MMR after the consolidation and maintained MMR for 6 months. High risk-patients were recommended alloHCT whereas low-risk patients were recommended continuous chemotherapy/autologous hematopoietic stem cell transplant (autoHCT). Due to patients' bias, a fraction of high-risk patients were treated with chemotherapy and a fraction of low-risk patients with alloHCT. AlloHCT improved overall survival in high-risk patients but impaired the survival of low-risk patients. Low-risk patients treated with chemotherapy/autoHCT had a low relapse rate. The authors conclude that MRD based treatment stratification may improve the outcome for *RUNX1-RUNX1T1* AML patients in CR1 (99). The 2018 Swedish national guidelines for treatment of AML includes MRD based treatment recommendations for

patients treated with curative intent, using RT-qPCR for *NPM1*-mutated and CBF-leukemia and MFC-MRD for other cases.

There are some retrospective studies suggesting that MRD status could be used to guide post-remission treatment with alloHCT in adult AML. Qin *et al.* used RT-qPCR of *CBFB-MYH11* to analyze MRD after second consolidation in AML patients with inv(16) (100). Patients with poor molecular response (defined as < 3-log reduction in fusion transcripts compared to pretreatment baseline) had significantly increased 3-year DFS and OS when treated with alloHCT as compared to treatment with chemotherapy or autoHCT. AlloHCT did not improve outcome for patients with good molecular response as compared to chemotherapy/autoHCT. Balsat *et al.* showed that adult patients with a less than 4-log reduction of mutated *NPM1* transcripts (mutation type A, B, D) in PB post-induction had improved outcome if they received alloHCT. This was not observed in patients with a reduction exceeding 4-logs (101). Earlier Buccisano *et al.* reported improved outcome for post-consolidation MRD positive (determined with MFC-MRD,  $\geq 0.035\%$ ) good- and intermediate risk patients who received alloHCT as compared to chemotherapy or autoHCT. This was not seen for MRD negative patients (102).

#### 1.6.10 PREEMPTIVE TREATMENT

For several AML subtypes there has been shown to be a delay between molecular relapse, as determined with RT-qPCR, and hematological relapse (103-105). This provides a time frame of a few months where preemptive therapy could be initiated.

In a small study by Sockel *et al.*, adult AML patients received azacitidine in case of molecular relapse or persistent MRD, defined as an increase or persistence in *NPM1/ABLI* > 1%, after end of treatment (106). Seven out of 10 treated patients were still in remission after a median follow-up time of 10 months, as compared to the previously described median times from molecular relapse using RT-qPCR to overt relapse of 2-4 months in *NPM1* mutated AML (25, 61). The prospective RELAZA study investigated the effect of azacitidine in AML and MDS patients undergoing alloHCT of which the majority had AML. Monitoring was performed regularly after alloHCT and patients displaying a minor response (donor chimerism in the CD34+ cell fraction <80% but without hematological relapse - *i.e.* not based on MRD) were offered treatment. Some treated patients had continuous response without need of further treatment. For patients treated with azacitidine who relapsed, the median time to relapse was 231 days from donor chimerism levels <80%, which was longer than previous reports (107).

In the following RELAZA2 study, adult patients with AML or MDS who achieved complete remission were MRD monitored prospectively for 24 months after end of treatment using quantitative PCR of mutated *NPM1* or fusion genes *CBFB-MYH11*, *DEK-NUP214*, *RUNX1-RUNX1T1* (108). Again, the proportion of AML patients was approximately 90%. Patients who were MRD positive (>1% in PB or BM) in remission received treatment with azacitidine. Transplanted patients were monitored with CD34+ donor chimerism as described in the RELAZA study. After six cycles of azacitidine MRD status was reassessed, and for negative patients the treatment was de-escalated. Thirty-six percent of treated patients reached MRD negativity. Hematological relapse was prevented in 51%. The other 49% relapsed after a median of 422 days, which was longer than expected when compared to previous results. The OS of the MRD positive patients that responded to azacitidine was similar to that of the MRD negative patients. The results suggest that preemptive therapy with azacitidine can substantially delay hematological relapse in MRD positive AML patients.

Pozzi *et al.* assessed *WT1* gene expression using RT-qPCR after alloHCT and the impact on outcome for patients with AML. They reported that *WT1* expression was the strongest predictor of relapse in multivariate Cox regression analysis. Further, patients with MRD positivity (expression levels >180 copies/10<sup>4</sup> *ABL1* after alloSCT) in remission were eligible for immune intervention either by DLIs or modulation of immunotherapy. Patients that had *WT1* expression levels >180 copies/10<sup>4</sup> *ABL1* after alloHCT but with GvHD, cord blood transplants, early relapse or non-availability of the donor, were not eligible for DLI treatment. Comparing the patients with increasing *WT1* levels who received DLIs and those who did not, the number of relapses was comparable, but patients receiving DLIs had a significantly better 5-year survival (44% vs 14%). However, whether this was due to a slower disease progress of the patients selected for DLI treatment or an actual effect of the treatment remains to be proven. They conclude that *WT1* expression could be used to guide early treatment intervention with immunotherapy (109).

## 1.7 HETEROGENEITY & EVOLUTION OF LEUKEMIC CELLS

*[...]there is a frequently recurring struggle for existence, it follows that any being, if it vary however slightly in any manner profitable to itself, under the complex and sometimes varying conditions of life, will have a better chance of surviving, and thus be naturally selected. From the strong principle of inheritance, any selected variety will tend to propagate its new and modified form.*

-Charles Darwin,  
*On the origin of species, 1859*

### 1.7.1 IMMUNOPHENOTYPIC SHIFTS IN MFC-MRD

The sensitivity in predicting relapses with MFC for MRD analysis is rather low as 20-40% of MRD negative patients relapse (13, 110-112). This is partly explained by immunophenotypic heterogeneity of the leukemic cells. Usually only a subpopulation of the leukemic cells has a distinct aberrant immunophenotype, required to be displayed on at least 10% of leukemic cells to define a LAIP. Further, so called immunophenotypic shifts can be observed where the immunophenotype of the leukemic cells alters over the course of treatment. Changes in immunophenotype between diagnosis and relapse have been described to occur in up to 90% of cases (113-115). These changes may reflect antigenic instability in the original leukemic cells or the emergence of a new dominating leukemic clone due to the selective pressure of chemotherapy. The current knowledge about changes in immunophenotype during treatment and imminent relapse is limited.

### 1.7.2 GENETIC HETEROGENEITY OF LEUKEMIC CELLS, CLONAL EVOLUTION & CLONAL HEMATOPOIESIS

#### 1.7.3 GENETIC HETEROGENEITY OF LEUKEMIC CELLS

As previously described, leukemia is derived from a single hematopoietic precursor cell that has acquired oncogenic mutations. In the process of leukemogenesis, daughter cells descending from this cell will subsequently acquire additional mutations. The cell type with the most malignant properties will be selected for and emerge as the dominating clone, although subclones in many cases will co-exist. High-throughput genomic analyses have based on variant allele frequencies established that AML often is

composed of multiple subclones (11, 116) (*Figure 7*). One of these studies reported that more than half of the investigated AML patients had at least one subclone in addition to the dominating clone (11). In analogy to the intra-tumor genetic heterogeneity described for solid tumors, a case study where exome sequencing was performed on bone marrow, aspirated from different anatomic sites (right and left iliac crest and sternum) in AML-patients, revealed differences in subclonal compositions in the different compartments (117). The existence of multiple subclones have implications for MRD-monitoring, and potentially also for treatment as novel targeted therapies are introduced.

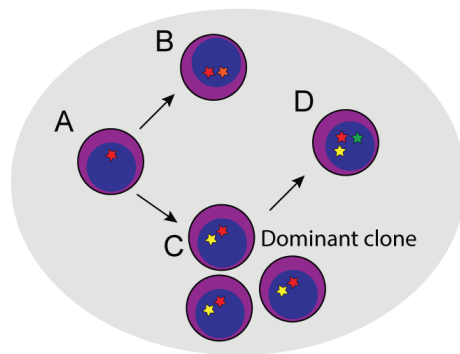

*Figure 7. Illustration of how the leukemic cells continue to accumulate mutations after the leukemia-initiating event (A), giving rise to a dominant clone (C) possessing a growth advantage over the other leukemic cells, but also to multiple coexisting leukemic subclones (B, D).*

#### 1.7.4 CLONAL EVOLUTION

This pool of genetically heterogeneous leukemic cells present at diagnosis will be exposed to treatment with chemotherapy which exerts a selective pressure on the leukemic cells. If the treatment fails to eradicate all leukemic cells, some cells with a genotype that renders them more chemotherapy resistant might persist and return as the dominant clone at relapse (*Figure 8*). Through this process, mutations that were identified in the pool of leukemic cells at diagnosis might not be detectable at relapse. The cytotoxic drugs used for treatment are mutagenic and can introduce new mutations in the surviving leukemic cells. These mutations can thus be detected at relapse but not at diagnosis. In addition, the inherent genetic instability of the leukemic cells contributes to acquisition of new mutations. This change in mutational profile is called clonal evolution (118). Some mutations, such as in the *NPM1* gene,



have been demonstrated to be stable during treatment (119, 120). Others, such as *FLT3*-ITDs, tend to change over the course of treatment (119). Therefore, recommendations against the use of mutations in *FLT3*, *NRAS*, *KRAS*, *IDH1*, *IDH2*, *MLL*-PTD and expression of *EVII* as single MRD markers has been given by the ELN MRD Working Party. However, mutations in these genes may have prognostic significance in combination with other MRD markers (64). On a side note, there also seems to exist a tumor heterogeneity at the epigenetic level at diagnosis as well as epiallele shifts through progression from diagnosis to relapse (121).

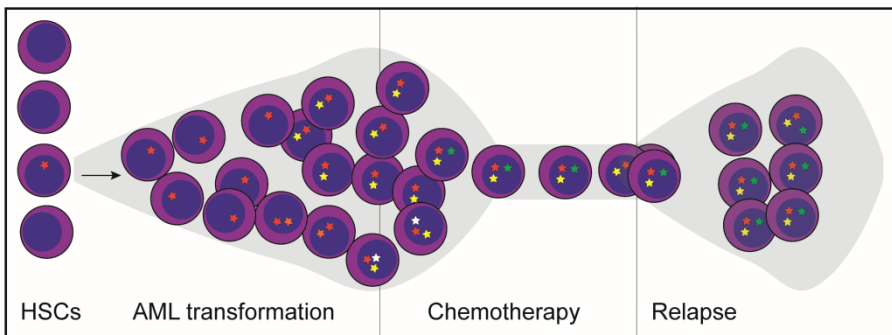

Figure 8. The leukemic cells at relapse will have some differences in genetic make-up as compared to the leukemic cells at diagnosis, i.e. clonal evolution, in part due to the selective pressure of chemotherapy as shown here.

### 1.7.5 CLONAL HEMATOPOIESIS

Hematopoietic cell clonality is not a phenomenon only related to AML, but is also found in healthy individuals. Two pivotal papers were published regarding age-related clonal hematopoiesis in 2014. They showed that 5-10% of individuals >70 years had mutations in genes often found mutated in MDS and AML (e.g. *DNMT3A*, *TET2*, *ASXL1*) in a substantial proportion of their blood cells (122, 123). These individuals had higher risk of developing hematological malignancies (MPN, MDS or AML) than individuals without age-related clonal hematopoiesis. As the majority of these patients never will develop a hematological malignancy, the condition is referred to as clonal hematopoiesis of indeterminate potential (CHIP) or sometimes ARCH (age-related clonal hematopoiesis). Only 0.5-1% of individuals diagnosed with CHIP progress to malignant disease (124). This premalignant condition has its equivalents in the premalignant conditions of the lymphoid lineage (monoclonal gammopathy of undetermined significance (MGUS) and monoclonal B-cell lymphocytosis (MBL)). The mutations associated with CHIP are mutations that are recurrent also in MDS and AML. Supposedly,



HSCs that acquire these mutations will expand as a result of an advantageous phenotype and increase the probability of acquisition of additional driver mutations. This highlights the stepwise progression from normal hematopoiesis to myeloid malignancy (18, 124).

### 1.7.6 AML RELAPSE

Approximately 30-40% of adult AML patients relapse, usually within 2 years from diagnosis (125, 126). Relapse is a result of insufficient eradication of leukemic cells, clonal evolution of preleukemic cells or a new malignancy induced by chemotherapy. The leukemic cells at relapse could therefore potentially harbour different mutations than at diagnosis, why new morphologic, immunophenotypic and genetic analyses should be performed. If the leukemia at relapse lacks resemblance of the leukemia at diagnosis, the possibility of a new treatment-related malignancy should be considered, especially for late relapses.

The prognosis after relapse is poor, with reported 3-year OS for adult AML patients of 24% (APL included) (127) and 1-year survival of 19-23% for patients with relapse after alloHCT (126, 128). The chance of cure is dependent on age, cytogenetic risk, duration of first remission and treatment with alloHCT in second remission (CR2). For patients eligible for alloHCT, the transplantation is performed as soon as possible after CR2 is reached, as it usually is shorter than the first remission (CR1). Although the relapse rate is equivalent in children, the outcome after relapse is better than for adults with reported total 5-year OS of 39% and 5-year OS of 61% for allografted patients (129). Hematological relapse is defined as presence of  $\geq 5\%$  leukemic cells in BM assessed by morphology or MFC or reappearance of blasts in blood (47). Monitoring of patients after end of treatment with RT-qPCR enables earlier detection of relapse, so called molecular relapse. Molecular relapse has for RT-qPCR been defined as an increase of MRD  $\geq 1\log_{10}$  between two consecutive samples in a patient with previous molecular remission (64). Molecular relapse is associated with a very high risk of hematological relapse (104, 105, 130). This information enables the possibility of preemptive intervention.

One aspect which needs to be considered when using MRD for monitoring after end of treatment is the relapse kinetics of the disease. Different subtypes of AML (*i.e.* with different genetic aberrations) have been shown to differ in progression time from molecular to hematological relapse. The reported time from molecular relapse in BM to haematological relapse for patients with *inv(16)* was 6 months; *NPM1/FLT3-ITD<sup>-</sup>* 4 months; *NPM1/FLT3-ITD<sup>+</sup>* 2

months and one month for patients with *KMT2A*-rearrangements (131). For patients with *RUNX1-RUNX1T1*, the reported time from molecular relapse in BM and PB to haematological relapse was 0.8 months and 1.6 months respectively (92). These differences could have implications for testing intervals as well as choice of preemptive treatment. The optimal testing intervals remain to be determined. The ELN MRD Working Party recommends monitoring of molecular MRD markers *NPM1*, *RUNX1-RUNX1T1*, *CBFB-MYH11* and *PML-RARA* every 3 months for 24 months after end of treatment (64).

## 2 AIM

The overall aim of this thesis has been to improve the treatment follow-up of patients with AML by analysis of MRD and, thus, to provide better support for treatment decisions and chance of improved survival.

### 2.1 SPECIFIC AIMS

- To develop and validate a next generation sequencing based method for MRD analysis in AML (Paper I and Paper II)
- To evaluate if MRD analyzed by deep sequencing predicts the outcome for patients with *NPM1* mutated AML undergoing alloHCT (Paper III)
- To assess the ability of patient-tailored deep sequencing MRD analysis of blood to detect a pending relapse in patients that have completed their AML treatment (Paper IV)



## 3 METHODOLOGICAL CONSIDERATIONS

This section provides an overview of the samples and methods used for the studies. Detailed descriptions are found in the Method sections of attached papers.

### 3.1 PATIENT SAMPLES

#### 3.1.1 PAPERS I & II

Bone marrow cells or peripheral blood from adults (Paper I) and children (Papers I & II) with AML were collected at diagnosis and during follow-up based on availability after complete diagnostic work-up at the Department of Clinical Chemistry, Sahlgrenska University Hospital. The pediatric patients were treated according to the NOPHO-DBH AML-2012 protocol. Patients with AML associated with trisomy 21, APL (t(15;17)(q22;q21); *PML-RARA*), juvenile myelomonocytic leukemia, AML secondary to bone marrow failure syndromes and treatment-related AML were excluded. The studies were performed according to the Declaration of Helsinki and approved by the Regional Ethical Review Board in Gothenburg. Informed consent was obtained from guardians and when age appropriate from the patients.

#### 3.1.2 PAPER III

Bone marrow aspirate slides from adult patients with AML were retrieved from biobanks at Sahlgrenska University Hospital, Gothenburg and Skåne University hospital, Lund. Included patients had undergone alloHCT between 2005 and 2015 and had identified mutation in the *NPM1* gene at diagnosis. Patients had consented to biobanking for research purposes and the study was approved by the Regional Ethical Review Board in Gothenburg.

#### 3.1.3 PAPER IV

Bone marrow or peripheral blood samples from children were collected at diagnosis and relapse. Blood samples were collected monthly after completion of therapy until relapse or end of follow-up (minimum 1 year from inclusion or 1.5 years after end of treatment). Samples were biobanked at Aarhus University Hospital for patients from Denmark, Finland and Norway, and at Sahlgrenska University Hospital for Swedish patients. All pediatric patients (0-17 years) treated on the NOPHO-DBH AML-2012 protocol that achieved CR after first line of therapy/alloHCT were eligible for enrollment. Only relapsed patients were included. Exclusion criteria for the

NOPHO-DBH AML-2012 protocol are stated in section 3.1.1. Written informed consent was obtained from guardians or when age appropriate from patients. The study was performed according to the declaration of Helsinki and approved by local or national ethics review boards in Denmark, Norway, Finland and Sweden.

## 3.2 FLUORESCENCE ACTIVATED CELL SORTING (FACS)

The use of cell sorting by FACS allows simultaneous enrichment of several cell populations from a single sample. The use of multiple antibodies in combination with analysis of cell size (forward scatter-FSC) and complexity (side scatter-SSC) enables good characterization of the target cells. This is in opposition to alternative methods such as enrichment with magnetic-activated cell sorting (MACS).

FACS was used for sorting of leukemic cells and lymphocytes (Paper I, II & IV) as part of the process to characterize the leukemic cells with regard to mutations. The rationale was to obtain the best estimation possible of the leukemic cell variant allele frequency (VAF), to assess which mutations were likely to be present in the majority of leukemic cells at diagnosis and therefore suitable MRD markers. The main sorting strategy was hence to use immunophenotypic markers which separated the leukemic cells from other hematopoietic cells, without obvious exclusion of any leukemic cells. As all AML samples are extensively analyzed with flow cytometry at diagnosis in clinical routine, the sorting strategy of viably frozen leukemic cells was possible to establish in advance. The samples were prepared using bulk lysis, followed by washing and staining. For the great majority of cases, the core blast identification markers CD45, CD117, CD34 and HLA-DR were used to identify leukemic populations (13). Lymphocytes were sorted based on their SSC properties and CD45 expression. An example of the gating strategy is illustrated in *Figure 9*. Satisfactory levels of purity at around 95% were reached for most cases.

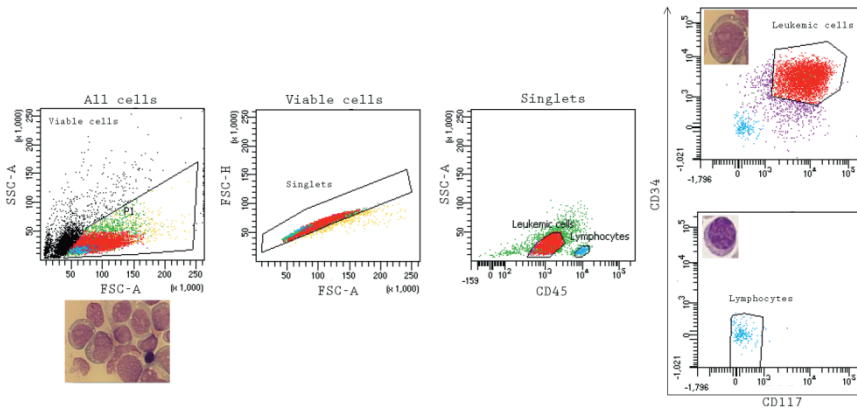

Figure 9. Illustration of the gating strategy used for FACS-sorting of leukemic cells and lymphocytes, selecting viable cells and singlets based on SSC and FSC properties, following gating of the  $SSC_{low}, CD45+H, CD34-$  and  $CD117-$  lymphocytes and the  $SSC_{low}, CD45+D, CD34+$  and  $CD117+$  leukemic cells (in this particular case).

### 3.3 NEXT GENERATION SEQUENCING

The dominating NGS method for the time being is the sequencing by synthesis (SBS) approach. In the preparation step, the DNA intended for sequencing is flanked with adaptor oligonucleotides. The end part of these oligonucleotides is complementary to clonally amplified oligonucleotides that are fixed to the flow cell glass. Each single-stranded DNA added binds to the flow cell and give rise to a cluster of identical strands through a bridge-amplification process (cluster generation). The adaptor sequence also contains a primer-binding site where the sequencing primer will bind. During sequencing, nucleotides are added in a cyclic manner and when the correct nucleotide is incorporated in the growing DNA strand, a fluorescent signal specific for the nucleotide is emitted and recorded. All signals from a given cluster are recorded together and millions of clusters are analyzed simultaneously. The sequencing is then repeated for the reverse strand after a DNA replication process. After the sequencing process is completed, the output sequencing data is aligned to the human reference genome and analyzed.

One application of NGS is to interrogate shorter genomic regions at very high resolution - targeted deep sequencing. Since leukemic cells have acquired mutations that do not exist in the healthy cells, these mutations can be used as

MRD markers (similarly as for RT-qPCR). In contrast to RT-qPCR, genomic DNA (gDNA) instead of mRNA is quantified which is directly correlated to the number of leukemic cells. Targeted deep sequencing as method for MRD analysis has been described in AML for recurrent mutations, either selected genes or gene panels, with varying applicability and sensitivity (7, 132-138). The use of exome sequencing and/or whole genome sequencing has also been described for identification of leukemia-specific mutations followed by targeted deep sequencing MRD analysis (and has been our approach in some of the studies included in this thesis) (139-141).

### **3.3.1 EXOME SEQUENCING**

In order to screen the genome of leukemic cells for mutations, two main NGS based options exist; whole genome sequencing (WGS) and whole exome sequencing (WES). In WGS, the entire genome is sequenced (exons, introns and intergenic regions) whereas in WES only the exons, which constitute a fraction of the entire genome, are sequenced. One advantage of WGS over WES is that it would enable detection of more mutations, with the possibility of identifying more MRD suitable mutations per case. Furthermore, the data should be more unbiased as oligonucleotide probes are used to hybridize to target regions in the genome in WES library preparation. The rationale for choosing WES over WGS in these studies was that protein-coding mutations, with potential leukemogenic properties were of most interest (for potential exploration in further studies). Further reasons were the local availability, lower cost, easier data storage and that the bioinformatics analysis of WES data was more established at study initiation.

To identify leukemia-specific mutations, exome sequencing was performed on DNA extracted from sorted leukemic cells and lymphocytes respectively (Paper I, II and IV). The Illumina platform was used (HiScanSQ/NextSeq500) using paired-end reads (2x75bp). Post-sequencing, reads were aligned to the human reference genome (build hg19, UCSC) using Burrows-Wheeler aligner (BWA) (142). For variant calling of SNVs, the software Mutect was used and small insertions/deletions were identified using Strelka and VarScan2 (143-145).

### **3.3.2 CHOOSING MUTATIONS SUITABLE FOR MRD-ANALYSIS**

In papers I, II and IV, we used FACS to sort leukemic cells and lymphocytes with the purpose of identifying mutations suitable as MRD markers using exome sequencing. Through this process we could identify leukemia-specific mutations, both potential driver mutations and passenger mutations.



Heterozygous mutations in a sorted cell population have a 50% VAF. A fraction of the mutations identified as leukemia-specific with exome sequencing have VAFs < 50%, suggesting subclonality for these mutations (Figure 10A). In order to only identify heterozygous mutations present in the majority of the leukemic cells, a 95% confidence interval (CI) for the true VAF was calculated for each identified mutation based on the observed VAF and the sequencing depth in each specific position. Mutations with an upper CI below 0.5 were considered potentially subclonal and thus primarily not suitable as MRD markers (Figure 10B).

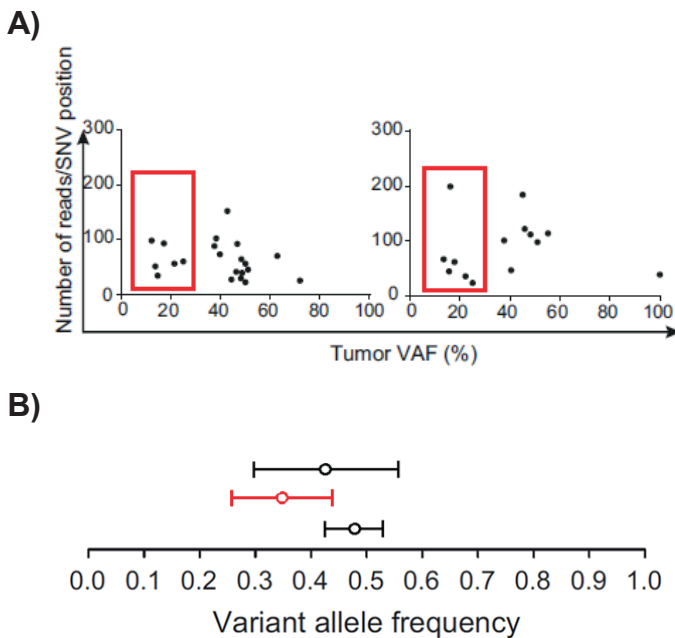

Figure 10. Leukemia-specific mutations identified in two cases of AML in paper I, where groups of mutations cluster at low frequency, suggesting subclonality (A, red boxes). Mutations not likely to be present in all leukemic cells, based on an upper 95% CI level for the true VAF below 50%, were not primarily used as MRD markers (B, mutations with 95% CI below 50% shown in red).

### 3.3.3 TARGETED DEEP SEQUENCING

In order to estimate the frequencies of MRD suitable mutations with high sensitivity in follow-up samples, an amplicon based sequencing strategy was chosen. There are other methods that could have been used for this intent, such as qPCR or ddPCR. However, both these methods require custom design of not only primers but also probes, which would make patient-tailored analyses more laborious. As outlined in paper III, targeted deep sequencing also permits analysis of unknown mutations in a given genomic region.

PCR primers were designed for the Illumina Truseq-library preparation system. Amplicons were designed to span 50-120 nucleotides 5'- and 3'- of the leukemia-specific mutation of interest. PCR products were purified using Agencourt® AMPure® XP beads (Beckman Coulter, Brea, CA) to remove residual primer and sequenced in multiplex with dual unique indexing on the MiSeq platform (Illumina, San Diego, CA) and using paired-end reads (2x150bp). The PhiX bacteriophage genome was added for increased library diversity. To achieve a high sequencing depth, only eight to ten samples were analyzed per run. No mismatches were allowed for demultiplexing, as compared to one mismatch allowed by default. Acquired reads were stitched using PEAR with default parameters and quality filtered using the FASTX-Toolkit (146). Alignment to the human reference genome was performed with the Burrows-Wheeler aligner (BWA) (142). Only reads with a perfect match of nucleotides flanking the mutation site was kept for analysis. The VAF was defined as (mutated reads/(wildtype reads + mutated reads)). The sequencing process is associated with some degree of base-calling errors and sequence specific errors, where GGC motifs are more affected (147, 148). To correct for position-specific errors to obtain error corrected VAF (VAF<sup>EC</sup>), we used reference samples for each analyzed position in Papers II and IV. A flow chart for the targeted deep sequencing process is showed in *Figure 11*.

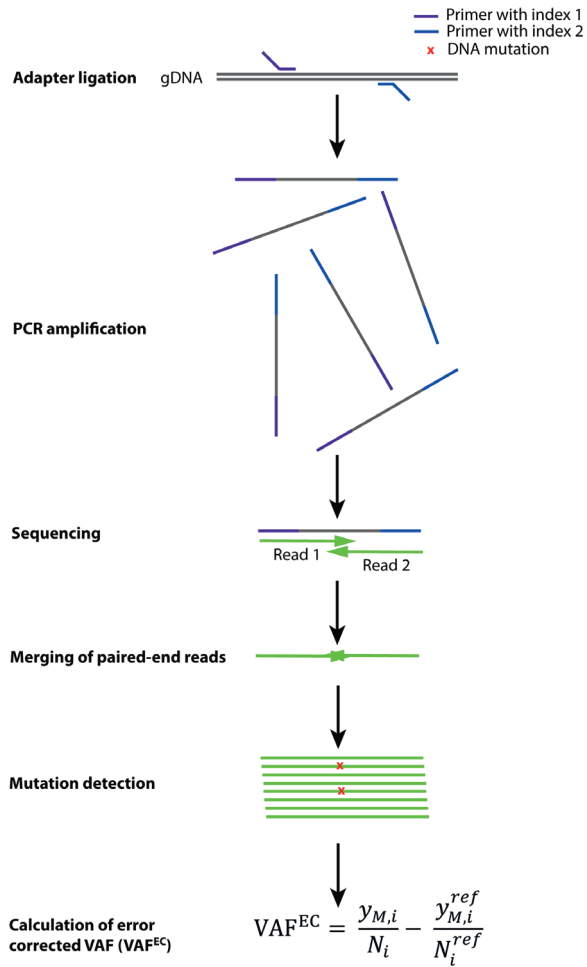

Figure 11. Illustrated is the work flow of targeted deep sequencing, from adapter ligation using custom made primers for the mutation region to mutation detection in aligned reads and estimation of  $\text{VAF}^{\text{EC}}$ .

## 3.4 SANGER SEQUENCING

Sanger sequencing was used to validate the performance of exome sequencing and the succeeding bioinformatics analyses for identification of leukemia-specific mutations in Paper I. As all tested mutations were validated and the same workflow was used in Papers II and IV, additional testing was considered redundant. DNA from diagnostic bone marrow cells was sequenced on an ABI Prism 3100 Genetic Analyzer (Applied Biosystems, Carlsbad, CA) using PCR primers specific for the mutation sites and BigDye Terminator v.1.1.

## 3.5 MOLECULAR CHIMERISM

Patients undergoing alloHCT are routinely monitored for engraftment efficacy after transplant using donor chimerism analysis. In this analysis the percentage of donor cells is estimated using PCR of short tandem repeat sequences or fluorescence in situ hybridization (FISH) of sex chromosomes, applicable in cases of gender mismatch transplantation. The method is less sensitive than targeted assays since it is not specific for leukemic cells and thus not a method for MRD analysis. However, there is a known association between increased amount of recipient cells (mixed chimerism) and relapse (149, 150).

In Paper III, patients with AML with mutation in *NPM1* were investigated regarding the association between targeted deep sequencing MRD positivity around the time of transplantation and outcome. As clinical data from bone marrow chimerism analyses was available for a fraction of the included cases, the results were compared to deep sequencing analysis.

## 4 RESULTS

### 4.1 PATIENT-TAILORED ANALYSIS OF MINIMAL RESIDUAL DISEASE IN ACUTE MYELOID LEUKEMIA USING NEXT GENERATION SEQUENCING (PAPER I)

One of the most important risk stratifying factors in AML is response to treatment, which is determined by analysis of MRD. The most established method for MRD analysis is MFC-MRD, which is applicable for the majority of AML patients but is also associated with several limitations. These limitations include difficulties in identifying immunophenotypes specific for the leukemic cells – LAIPs. Further, cells with the identified LAIPs often only represent a fraction of the leukemic cells, which hampers the sensitivity of the method. Higher sensitivity is acquired with RT-qPCR analysis of recurrent genetic aberrations, but the analysis is reserved for the minority of AML patients with recurrent chromosomal translocations or mutations.

We therefore decided to develop a complementary method using targeted deep sequencing. To identify MRD suitable target mutations highly specific for the leukemic cells, but also present in the majority leukemic cells of the individual patient, leukemic and normal cells (lymphocytes) from 17 patients were sorted from diagnostic samples using FACS. DNA from respective cell type was exome sequenced after which bioinformatic as well as statistical analyses were performed. In this manner we identified MRD suitable mutations at diagnosis for all but one patient. A total of 262 leukemia-specific mutations were identified in the 17 analyzed cases using exome sequencing, of which 191 were considered MRD-suitable (median 11, range 0-25, per case). There was a correlation between mutation burden and age ( $r_s = 0.76$ ,  $p < 0.001$ ) and the number of mutations was significantly lower in children (median 6, range 0-10) than in adults (median 18.5, range 12-34). The most common mutation class was SNVs, with transitions occurring more frequently than transversions. We also compared the results from exome sequencing to results from conventional genetic analyses used in routine diagnostics. Mutations in *NPM1*, *FLT3*-ITDs, numerical and most structural chromosomal aberrations were identified, but not balanced translocations. Deep sequencing amplicon libraries were created using primers specific for the target region and sequenced at high depth on the Illumina Miseq platform.

Dilution series of leukemic DNA, containing three leukemia specific SNVs in different genes and a 4 base pair (bp) insertion in the *NPM1* gene, demonstrated linearity down to 0.025% for SNVs and 0.017% for the 4 bp insertion. Limits of detection were established at 0.025% for SNVs and 0.007% for the insertion based on the obtained VAF in normal samples (mean+3SD). As proof of principle, bone marrow samples from a patient with AML under treatment were analyzed for MRD with targeted deep sequencing. There were high and significant correlations between the detected mutation load of the three SNVs and the *NPM1* insertion. The mutation load for the *NPM1* insertion was confirmed using qPCR of DNA, showing good correlation between results from deep sequencing and qPCR.

Limitations of this study included the fact that the study cohort was small and not population based and the identified mutations might therefore not be fully representative for AML. Further, only mutations from one patient were analyzed with targeted deep sequencing.

In conclusion, we showed that exome sequencing of DNA from cells sorted with high purity at diagnosis can identify leukemia-specific mutations that may be used for MRD analysis in a personalized manner in both adult and childhood AML. We also demonstrated the potential of targeted deep sequencing as a sensitive method for analysis of small amount of residual leukemic cells.

## 4.2 ACCURATE AND SENSITIVE ANALYSIS OF MINIMAL RESIDUAL DISEASE IN ACUTE MYELOID LEUKEMIA USING DEEP SEQUENCING OF SINGLE NUCLEOTIDE VARIATIONS (PAPER II)

Molecular MRD analysis is today only available for the minority of AML patient with recurrent cytogenetic aberrations or mutations. To address this limitation, we developed patient-tailored targeted deep sequencing. This method enables the use of also non-recurrent leukemia-specific somatic mutations as markers for MRD, which could extend the applicability of molecular MRD analysis to a larger number of patients.

In this study we validated the patient-tailored targeted deep sequencing method for MRD analysis described in paper I. The same method was used as in paper I, but with some elaborations. To correct for sequencing errors and hence achieve a better determination of the true VAF, we corrected each result for the background signal in the specific position. This was performed by determining the VAF of the position of interest in a reference sample from a healthy individual. The resulting position-specific error corrected value was denoted VAF<sup>EC</sup>.

This correction reduced the noise level and was shown to be important at lower VAF levels due to larger relative differences between VAF and VAF<sup>EC</sup>. For estimation of the limit of detection (LOD), normal samples were analyzed for 15 different SNVs. The LOD was dependent on the sequencing depth and estimated to VAF<sup>EC</sup> 0.02% at a sequencing depth of  $5 \times 10^5$  reads, with only minor decrease in LOD at higher depths. To determine linearity, a commercially available DNA reference standard containing five different SNVs and one deletion at 1% VAF was used. Dilution series were performed in triplicate in the low VAF range (0.008-1%) followed by targeted deep sequencing on the Illumina MiSeq platform as previously described. Linearity was seen down to levels of approximately VAF<sup>EC</sup> 0.03%. Between run variations (CVs) were estimated for SNVs at different variant allele frequency levels. At VAF 1% the CV ranged between 2.2%-5.7% and for samples diluted to VAF 0.1% between 8.8-19.4%. A low relative bias of 7.9% (2.5%-15.3%) was seen at VAF 1%. To test the method during treatment follow-up, biobanked bone marrow samples from six children with AML were analyzed using targeted deep sequencing at different time points during treatment. Two to three mutations per patient were used as MRD-

markers, determined MRD suitable using our filtering system described in paper I. The results from deep sequencing were compared to MRD analysis using MFC-MRD and showed high concordance and superior sensitivity. Two patients, who later relapsed, were MRD positive with deep sequencing and MRD negative with MFC-MRD after end of induction therapy, the risk stratifying time point in the protocol. Two patients, who remained in remission, were MRD negative with both methods after end of induction therapy. Regarding the two additional patients, one lacked data from MFC-MRD for comparison and the final patient was treated off-protocol. Overall, none of the patients were at any time determined MRD positive with MFC-MRD and MRD negative with deep sequencing. Further, there was a high concordance with fusion gene expression *RUNX1-RUNX1T1* and *KMT2A-MLLT10* using RT-qPCR. All mutations present in bone marrow at VAF >0.1% were detected also in peripheral blood, which is of importance for applicability of the method for MRD-surveillance in blood.

The limitations associated with this study were that not all possible SNVs were included in the study of accuracy, precision and limit of detection. Further the low number of included patients only allowed for descriptive study on leukemia kinetics using different methods for MRD analyses and no conclusive results on the predictive value of deep sequencing.

In conclusion, we showed that patient-tailored targeted deep sequencing of SNVs, present in virtually all cases of AML, enables reliable and sensitive MRD analysis. Good accuracy, precision and linearity were seen at low VAF range. We reported concordance of results from targeted deep sequencing with MFC-MRD and RT-qPCR with a suggested superior sensitivity over MFC.



### 4.3 MINIMAL RESIDUAL DISEASE ASSESSED WITH DEEP SEQUENCING PREDICTS RELAPSE AFTER ALLOGENEIC STEM CELL TRANSPLANT IN AML (PAPER III)

In addition to evaluating early response to treatment, MRD measurements could be used in patients undergoing alloHCT for risk stratification and subsequent adjustment of immunomodulatory treatment (immunomodulatory drugs or DLIs). Mutations in the *NPM1* gene are recurrent in AML, present in approximately 30 % of adult AML cases (151). The reported stability of mutations in the *NPM1* gene over the course of treatment makes these mutations suitable as MRD markers (43, 152-154). RT-qPCR has been established as a predictive tool by several groups for MRD analysis in AML with mutation in the *NPM1* gene following alloHCT (97, 98). However, to detect the numerous different recurrent mutations in the *NPM1* gene, a large number of specific RT-qPCR assays would be required. Using targeted deep sequencing, the same assay could be applied for all recurrent insertions in exon 12 of *NPM1*, and serve as a cost-effective alternative for MRD analysis. Here we evaluated the predictive value of this method.

Twenty-nine patients in morphological remission at the time of alloHCT were assessed for the prognostic impact of *NPM1* MRD status on relapse-free survival (RFS) and overall survival. Samples from within one month before alloHCT were available for 25 patients and from three months after alloHCT for 27 patients. Targeted deep sequencing was performed as described in paper I (140). A cutoff value of VAF 0.02% for MRD positivity was used based on previously shown linearity of the assay down to this level. The study outline is illustrated in the *figure 12*.

Two out of 3 pre-transplant MRD positive patients relapsed, as compared to 4 out of 22 MRD negative patients. Post-transplant, 4 out of 5 MRD positive patients and 3 out of 22 MRD negative patients relapsed. MRD status revealed significant associations with clinical outcome: 3-year RFS 20% for MRD positive vs 85% for MRD negative ( $p < 0.001$ ) and OS similarly 20% vs 89% ( $p < 0.001$ ) respectively. Post-transplant deep sequencing MRD predicted both RFS (HR 45, 95% CI 2-1260,  $p = 0.025$ ) and OS (HR 49, 95% CI 2-1253,  $p = 0.019$ ). This was independent of other known risk factors including age, disease status at transplant, conditioning intensity, cytogenetic risk stratification and *FLT3*-ITD status. The result from bone marrow chimerism analysis that was performed as part of clinical routine approximately 3 months post-transplant was compared to results from *NPM1* MRD analysis.

Of the five post-transplant MRD positive patients, only one displayed mixed T cell chimerism. No significant association was found between T cell chimerism status and outcome.

Limitations of the study included that it was retrospective, that the study cohort was relatively small and involved limited comparisons to other methods.

In summary, we reported deep sequencing of *NPM1* to be an applicable and predictive tool for MRD assessment after alloHCT in AML, confirming previous reports on MRD analysis using RT-qPCR. The possibility to predict risk of relapse in patients undergoing alloHCT using MRD analysis by targeted deep sequencing of *NPM1* would provide a better decision support for treatment and thus the chance of improved survival.

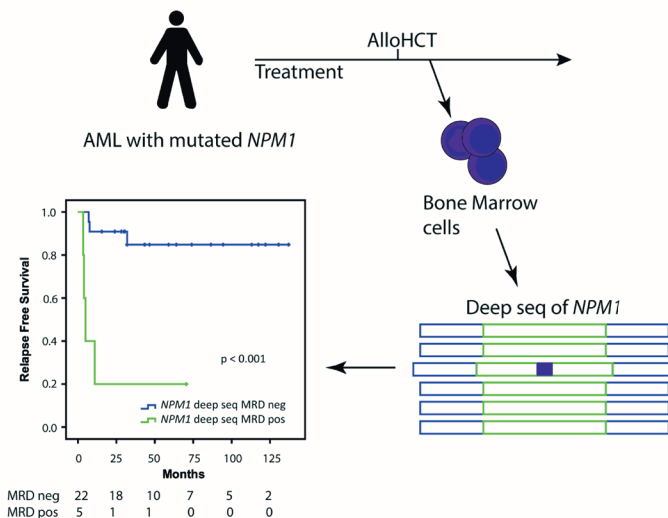

Figure 12. Visual abstract of Paper III.

## 4.4 PATIENT-TAILORED DEEP SEQUENCING OF BLOOD ENABLES EARLY DETECTION OF RELAPSE IN CHILDHOOD ACUTE MYELOID LEUKEMIA (PAPER IV)

Despite the fact that the majority of children with AML reach complete remission, 30-40% will eventually relapse (155, 156). After relapse the prognosis is dismal with a 5-year OS of 40%, even with intense treatment (129). For adult AML, a recent study has shown that detection of molecular relapse enables preemptive treatment with azacitidine that prolong the time to, or even prevent, hematological relapse (108). For transplanted patients, preemptive interventions upon molecular relapse using DLIs and modulation of immunosuppression have been described (157-159). Here we applied our patient-tailored deep sequencing MRD strategy to analyze blood samples preceding relapse to determine the applicability for early detection of relapse and to study relapse kinetics.

Children treated with the NOPHO-DBH AML-2012 protocol since 2016 were offered participation in the “Early detection of relapse study”. Blood samples were prospectively collected monthly after end of treatment and biobanked. Children with relapse during the sampling period were included in this study. At the time of writing this thesis, nine childhood AML patients have been included (of a total expected number of approximately 20 included patients).

In total, 53 leukemia-specific mutations were identified at diagnosis (median 4, range 2-12 per patient), of which 33 were present also at relapse (median 2, range 1-9 per patient). Fewer than half of the genes identified to be mutated at diagnosis were reported in the COSMIC database to be recurrently mutated genes. Mutations that fulfilled our previously established criteria for being suitable as MRD markers were identified in 7/9 cases. A median of 2 (range 1-3) leukemia-specific SNVs were quantified per patient with deep sequencing in the PB samples preceding relapse. In 8/9 cases, leukemia-specific mutations were detected in blood before hematological relapse, and the first sample displaying MRD positivity was collected at a median of 90 days (range 0-241 days) before relapse. The relapse kinetics varied between individuals and AML subtypes. For patients not receiving preemptive therapy, the median doubling time of the mutation burden was 7 days (range 4-28 days) and for patients receiving preemptive treatment 25 days (14-26 days). We explored a potential definition of molecular relapse as a doubling of VAF<sup>EC</sup> between two MRD positive samples in a patient who previously

tested negative. This occurred in 6/9 patients at a median time of 80 days (range 25-227 days) before relapse and for 2 additional patients VAF<sup>EC</sup> doubling coincided with overt relapse. The ELN recommended definition of molecular relapse, one log<sub>10</sub> increase between two positive samples in a patient who previously tested negative, occurred only in 3/9 patients. For two of these three patients, the one log<sub>10</sub> increase coincided with overt relapse. Thus, VAF<sup>EC</sup> doubling could be a better definition of molecular relapse when analyzing mutation burden than the one log<sub>10</sub> increase commonly used for transcripts.

The limitations of this study include that no comparisons to other methods for MRD analysis was performed and that only relapsed patients were analyzed. The low number of patients included so far limits the possibility to compare the relapse kinetics of different AML subtypes.

In conclusion, the results showed that patient-tailored deep sequencing enables early detection of relapse, permitting molecular monitoring after end of treatment with the potential to guide preemptive treatment.

## 5 DISCUSSION

This thesis aimed at improving the treatment follow-up for patients with AML by investigating the potential of targeted deep sequencing for analysis of MRD. We report that MRD-suitable SNVs can be identified with exome sequencing at diagnosis for the majority of patients and that these mutations can be reliably monitored with high sensitivity during follow-up with targeted deep sequencing. The degree of sensitivity fulfills the ELN consensus specification for molecular MRD analyses of detection down to 0.1% leukemic cells. Targeted deep sequencing allows for analysis of residual leukemia during treatment (Paper I & Paper II), around the time of alloHCT (Paper III) and for monitoring of blood after end of treatment for early detection of imminent relapse (Paper IV).

### 5.1 CHALLENGES OF MRD TESTING IN AML

Although abundant literature shows superior outcome for MRD negative over MRD positive patients, a major limitation at the moment is the lack of large prospective randomized trials showing that relapse risk can be reduced in MRD positive patients with treatment intervention (160). There is also a vast variation in study design concerning methodology, cutoff for MRD positivity, testing time points and sample types.

Many studies have used specific landmark time points during or after treatment. Instead of using absolute levels in some studies exploring RT-qPCR, the relative differences between measurements have been used for risk stratification (161-163). The time points that are most discriminatory in outcome and most useful in clinical practice remain to be determined for different subtypes of AML and methods used. Conceivably, the later the time point displaying MRD positivity during treatment, the stronger predictor of adverse outcome (due to chemotherapy resistance of leukemic cells). However, risk stratification at early time points yields more auxiliary time for treatment planning. Perea *et al.* reported a higher cumulative incidence of relapse (CIR) for MFC-MRD positive ( $\geq 0.1\%$ ) and a lower CIR for MFC-MRD negative adult AML patients after end of treatment as compared to earlier time points during treatment (164). Tierens *et al.* showed that MFC-MRD positivity ( $\geq 0.1\%$ ) before consolidation treatment had higher association to adverse outcome than MRD positivity after first induction in childhood AML (60). The instruction in the current Swedish protocols (both for adults and children) is to use MFC-MRD after two courses of chemotherapy, with 0.1% leukemic cells as cutoff.

Bone marrow is the most commonly used material for MRD analysis. A correlation between levels in BM and PB has been shown with different methods (MFC, RT-qPCR & targeted deep sequencing), but generally with multifold lower MRD levels in PB (141, 165-167). Krönke *et al.* analyzed paired BM and PB samples with RT-qPCR of *NPM1* and reported discrepant results during the induction and consolidation period (46% of PB negative samples showed positivity in BM) (167). After treatment this number decreased to 18%. The results from this study suggest a higher sensitivity of BM at early time points. Some studies have reported that presence of MRD during treatment using RT-qPCR PB is equally (CBF-AML) or more (*NPM1*) discriminatory of outcome than in BM (91, 161). RT-qPCR MRD analysis of *RUNX1-RUNX1T1* in BM after end of treatment has been shown more sensitive over analysis of PB, but only PB was predictive of relapse (168). Another study investigating adult AML patients with *RUNX1-RUNX1T1* reported that an achievement of a 2.5  $\log_{10}$  reduction in fusion transcript levels after course 1 in both BM and PB was associated with a lower risk of relapse (92). Lower risk of relapse was also seen for patients achieving a 3  $\log_{10}$  reduction after course 2. After end of treatment, MRD negativity in both BM and PB was an independent favorable predictive marker for relapse risk and OS. In the monitoring situation, the use of blood instead of bone marrow is associated with several practical advantages, especially in childhood AML where general anesthesia is needed for bone marrow aspiration. The potential usefulness of PB over BM at different time points using different methods needs to be further clarified.

No method used for analysis of MRD has perfect sensitivity and specificity. Regardless of method used, a proportion of MRD negative patients seems to relapse. There are several possible reasons for this. a) There could be residual leukemic cells below the detection limit of the MRD assay used. b) The leukemic cells might lose the MRD markers during the course of treatment through immunophenotypic shift or clonal evolution. c) The sample could be unrepresentative, where non-homogenous distribution of the leukemic cells in bone marrow or blood, hemodilution or scarce sample material could render a false negative result (117, 169). Not all MRD positive patients are bound to relapse regardless of method. It is known that some leukemia-specific fusion transcripts can be detected in the bone marrow of patients remaining in long-term remission (170-172). Possible explanations include that the immune system can hold the low number of leukemic cells at bay or that the target cells are in fact not cells with inherent potential to cause relapse (*e.g.* preleukemic mutations). The inter- and intraindividual genetic and immunophenotypic diversity of AML necessitates individualized MRD

testing, where clinically relevant time points of testing, sample types and thresholds for MRD positivity have to be identified for each individual assay.

## 5.2 WHAT ARE WE MEASURING?

The aim of any MRD analysis in AML is to adequately determine the number of persisting cells with the potential to cause relapse. It is thus important to keep in mind what we are measuring using different methods for MRD analysis (*i.e.* target deep sequencing, RT-qPCR and MFC-MRD).

In targeted deep sequencing, leukemia-specific mutations are quantified at the gene level – DNA level. Since each cell contains two copies of each gene (alleles), and the mutations in most instances occur in one of these alleles (heterozygous mutations), the ratio is exactly 1:2 between the number of mutations and originating cells. In RT-qPCR, the number of transcripts originating from the leukemia-specific genetic aberration is analyzed – mRNA level. Here, there is no exact relationship between the sample target gene mRNA expression and the number of originating cells, as the gene expression at the cell level can vary greatly. This means that the level of detection varies between different RT-qPCR assays, but also that the window of detection is generally broader than for MRD analyses at the DNA level. In MFC each cell is analyzed for presence, absence or aberrant expression of cell-surface or cytoplasmatic antigens. Thus, the markers analyzed are not directly reflecting the leukemogenic genetic lesions. Clearly abnormal immunophenotypes can be used for MRD analysis, but are usually not present on all cells suspected to be leukemic. Further it can be difficult to distinctly separate the leukemic cells from normal cells in a regenerating bone marrow.

The fact that different methods to measure MRD have different biological molecules as their targets and are associated with different technical difficulties entails that different results could be obtained from measurements of the same samples. The interpretation of discordant results can be challenging. In paper II we compared MRD assignments from targeted deep sequencing with those obtained from MFC-MRD. Concordant results were seen for 18/27 investigated samples. Nine samples were determined MRD positive with deep sequencing and MRD negative with MFC. No samples determined negative with targeted deep sequencing were determined positive with MFC, suggesting a lower sensitivity of MFC. Higher concordance was seen between deep sequencing and RT-qPCR of fusion transcripts *RUNX1-RUNX1T1* and *KMT2A-MLLT10*, where 13/14 samples had concordant MRD assignments (8 MRD positive and 5 MRD negative with both methods). Other

studies have described low concordance rates when comparing MRD measurements obtained from MFC and RT-qPCR after induction. Inaba *et al.* studied MRD response after induction in childhood AML and showed that 86% of samples determined MRD positive with RT-qPCR were determined MRD negative with MFC. Similarly to what we showed for deep sequencing in paper II, they also describe that almost all samples (99%) determined to be MRD negative with RT-qPCR were also MRD negative by MFC (82). No additional predictive value of RT-qPCR to MFC-MRD was seen. However, only a few patients monitored with RT-qPCR relapsed. In a study from our research group, Karlsson *et al.* demonstrated slower response kinetics during treatment in childhood AML when MRD was assessed at day 15 after induction and before consolidation with RT-qPCR of CBF-AML and *KMT2A*-rearrangements, than for MRD assessed by MFC analysis. They further showed that this could be explained by the presence of fusion transcripts in cells with mature immunophenotypes, *i.e.* cells that are not defined as MRD in the MFC analysis (173). The presence of AML associated fusion transcripts in a mature cell strongly implies leukemic descentance. However, as previously described in *Challenges of MRD testing in AML*, it is not always clear which leukemic cells that have the inherent potential to cause relapse. The differentiated cells harboring leukemic fusion transcripts probably constitute of cells without leukemogenic potential. An alternative explanation to obtaining a relatively higher MRD result from molecular MRD analysis in comparison to the number of immature cells in the sample, would be that the target gene is expressed in preleukemic cells lacking additional mutations contributing to leukemic transformation. The persistence of some fusion transcripts in long-term remission has been described (82, 170-172), but also for leukemia associated somatic mutations, which is further elaborated in the section below.

### 5.3 IDENTIFYING MRD SUITABLE SOMATIC MUTATIONS

To make a well-grounded assessment of the MRD-suitability of identified mutations in the clinical setting, *i.e.* mutations specific to leukemic cells with presence in the majority of leukemic cells, an adequate estimate of leukemic cell count is needed. This is necessary in order to identify mutations present in the all leukemic cells, including the dominating clone and potential subclones, see *Figure 7*. In papers I, II and IV, we have used FACS sorting to enrich the leukemic cell population and normal lymphocytes before exome sequencing. In paper I, we showed that this procedure could be used to identify leukemia-specific mutations, present in the majority of leukemic



cells and hence suitable as MRD markers, already at diagnosis. The exclusion of potential subclonal mutations was based on mutation variant allele frequencies and their accuracies, see *Methodological considerations* section 3.3.2. Further, we reported that these mutations could be used for patient-tailored analysis of MRD with targeted deep sequencing. FACS sorting at diagnosis enables identification of leukemia-specific mutations in samples with relatively low leukemic cell count. This could otherwise be a challenge in a leukemic sample intermixed with normal cells and potential tumor heterogeneity. Further, constitutive DNA can be obtained directly at diagnosis without additional sampling. The genomes of childhood AML harbor very few recurrent mutations and the mutation spectrum is different from adult AML, as shown by us and others (15, 140, 174, 175). Thus, the use of a global sequencing strategy, like the one we have described, is probably necessary to identify somatic mutations in children. The relatively cumbersome process of FACS sorting and exome sequencing is likely not necessary in adult AML, where sequencing panels targeting genes with mutations recurrent in myeloid malignancies have been shown effective to identify somatic mutations at diagnosis which can be used for MRD analysis (77, 135, 137, 176-179).

There are also reasons to use several markers of the leukemic cells for analysis of MRD, which has been our aim in the papers involving patient-tailored targeted deep sequencing. Precaution is motivated in cases of substantially diverging results in MRD levels between mutations in the same sample. One reason is the potential risk of choosing subclonal mutations as outlined above. Another reason is the potential risk of clonal evolution, where some mutations have been described to be lost at high frequency during treatment, see *Introduction*, section *Clonal evolution*. Naturally, not all such mutations have been identified yet or can be predicted. Both of these scenarios could lead to an underestimation of mutational burden. There is also a risk of using preleukemic mutations that are not specific to the leukemic cells. Clonal hematopoiesis is found in 5 to 20% of individuals older than 70 years. In these individuals, the blood cells harbor premalignant mutations at low frequencies, and most common in the genes for epigenetic modifiers *DNMT3A*, *TET2* and *ASXL1* (DTA) (122, 123). Preleukemic mutations could rise in myeloid progenitor cells with selective spread of the mutation to parts of the myeloid compartment, but also in HSCs which would disseminate the mutation to all directly descending hematopoietic cells. Allowing a bit of speculation; when using lymphocytes as constitutive genome from a case of the latter scenario for exome sequencing, preleukemic mutations could potentially be excluded through bioinformatics filtering if the mutation burden is similar for leukemic cells and lymphocytes. More

likely, the mutation burden is lower in the lymphoid compartment and the preleukemic mutations would be retained in the bioinformatics analysis. This would also be the case when using another source of constitutive DNA (*e.g.* skin or buccal swabs). In the scenario of preleukemic mutations being present in parts of the myeloid compartment, including the leukemic cells, the use of either lymphocytes or other tissues for constitutive DNA would lead to preleukemic mutations being retained in bioinformatics analysis. Indeed, when we subjected granulocytes and lymphocytes, isolated from apparently healthy donors, to exome sequencing in paper I we identified a few low-frequency mutations specific to the granulocytes. The mutations did not pass the criteria of being MRD suitable. The potential exclusion of preleukemic mutations is not problematic as they are unattractive MRD markers, but the risk of choosing preleukemic mutations needs to be considered.

As previously described, *DNMT3A* mutations are reported to persist in complete remission, indicating that they are preleukemic events (45, 46, 180-182). These studies have shown that persistence of *DNMT3A* mutations confer no prognostic significance. However, a recent study reported that patients with at least one persisting mutation in remission (most frequently seen in *DNMT3A*) had worse outcome than patients without persisting mutations (183). Further studies are needed to elucidate these conflicting results. Another study reported that non-leukemic clones harboring recurrent mutations in *TP53*, *DNMT3A*, *TET2*, *ASXL1* rapidly increased after induction treatment together with concomitant clearance of the AML-associated mutations (184). These non-leukemic mutations were identified at low frequencies already at diagnosis. In comparison to the population normally associated with CHIP, the investigated patients were relatively young and the progression of CHIP is slow. The authors propose the rapid expansion (up to 150-fold in 2 months) implies that chemotherapy confers a competitive advantage to HSCs harboring these mutations. The mutations were not present in the relapsing clone either, so the potential clinical importance is unclear. Mutations in *IDH2* have similarly to the DTA-mutations been described to persist in long-term remission and are also presumed to be preleukemic mutations. Mutations in *IDH2* contribute to a block in myeloid differentiation via histone hypermethylation. A study of the selective *IDH2* inhibitor Enasidenib, shown to promote myeloid differentiation, in relapsed of refractory AML reported that *IDH2* mutations (and other cytogenetic aberrations) were retained in mature granulocytes from patients in remission (185).

Germline mutations need to be excluded in some instances, as their VAF will not correlate to disease burden, through sequencing of constitutive DNA. The ELN recommends sequencing of constitutive DNA when using mutations in genes where germline mutations are known to be predisposing of AML development as MRD markers (e.g. *RUNX1*, *GATA2*, *CEBPA*) (64). The mutations mentioned in this section, frequently seen in AML and MDS, should due to their occurrence in non-leukemic cells be avoided as single markers for MRD. An exception could perhaps be monitoring after alloHCT, where these mutations potentially could be explored as markers for reappearing recipient hematopoiesis (186). In molecular MRD analysis, germline or preleukemic mutations should be suspected if the VAF remains relatively stable despite decreasing blast count (64).

## 5.4 INDIVIDUALIZED MRD MONITORING IN AML

The currently used methods for MRD analysis are associated with drawbacks. Approximately 20-40% of MFC-MRD negative AML patients relapse, suggesting that true low-risk cases cannot reliably be identified using this method (13, 110-112). As previously described, RT-qPCR is only applicable for the minority of AML patients with recurrent genetic aberrations. To increase the applicability of MRD analysis in AML, other methods are required. In paper II, we validated our patient-tailored targeted deep sequencing assay. Here we showed that this is an accurate and sensitive method for MRD analysis of leukemia-specific mutations. The inherent sequencing error rate of current NGS platforms calls for efforts to reduce the sequencing error background. Several methods to address this have been described including bioinformatics processing and the use of reference samples. In paper II, we applied a method to correct for sequencing errors by the use of reference samples, reaching a limit of detection of  $\text{VAF}^{\text{EC}}$  0.02%. (141). Others have pursued the use of unique molecular identifiers (UMIs) for barcoding of each DNA molecule before PCR amplification of the sequencing library (135, 137, 176, 187, 188). This is a process which enables identification and exclusion of reads with PCR or sequencing errors. Thol *et al.* demonstrated a detection limit of VAF 0.005% for two mutations in the genes *IDH1* and *IDH2* in a dilution series experiment using UMIs (135). In the cohort of 96 AML patients MRD positive before alloHCT, analyzed by custom NGS analysis, the VAF ranged between 0.016% and 4.91%, *i.e.* the lowest measurement was not that different from the LOD of  $\text{VAF}^{\text{EC}}$  0.02% which we have described. They reported that MRD positivity before alloHCT was highly predictive of outcome. A combination of sequencing error

reducing approaches is likely the way forward to reach levels of detection for targeted deep sequencing comparable to those for quantitative PCR. The cutoff for MRD positivity in the studies below exploring NGS based MRD analysis of patient-specific mutations in adult AML are hence generally higher than for qPCR-based assays.

The prognostic importance of clearance of patient-specific mutations has been shown for adult AML by several research groups. Hirch *et al.* reported that persistence of two or more mutations in more than 0.4% of cells in remission samples was associated with decreased overall survival (137). Jongen-Lavrencic *et al.* interestingly reported that the combined use of MFC-MRD and sequencing MRD in CR confer additive prognostic value for relapse rate and overall survival as compared to either method alone (177). In a study by Gaksch *et al.*, analysis of mutation clearance post-consolidation showed that persistence of mutations (MRD positivity defined as VAF >0.5%, *DNMT3A* mutations excluded) was significantly associated with shorter RFS, but not OS. MRD positivity was in multivariable analysis, together with age, leukocyte count and genetic risk shown to be predictive of relapse (176). Press *et al.* used a 42-gene NGS sequencing panel to analyze MRD within 30 days before alloHCT. The CIR post-transplant was significantly higher in patients with pre-transplant MRD positivity (VAF >0.5%). MRD positivity was also shown to be an independent predictor of relapse after adjustment for *TP53* mutations and conditioning regimen (179). In a study with similar setup (NGS panel for identification of recurrent mutations at diagnosis followed by custom amplicon sequencing of follow-up samples), Thol *et al.* reported detection of recurrent mutations in a cohort of adult AML before alloHCT (MRD positive samples ranging between VAF 0.016% - 4.91%) to be an independent predictor of CIR (135). In conclusion, these studies show the prognostic potential of targeted deep sequencing and promise a broader applicability of MRD analysis in AML.

## 5.5 NGS – BASED MRD ANALYSES IN AML WITH MUTATED *NPM1*

As described previously, insertions in *NPM1* are frequently recurrent in AML. Thirty percent of adult AML have a mutation in *NPM1*, for which analysis is included in clinical routine. Mutations in *NPM1* have been reported as reliable MRD markers, and are extremely suitable targets for deep sequencing due to mutation heterogeneity. There is a plethora of recurrent insertion mutations in exon 12 of *NPM1*, though some are more frequent. A major advantage of targeted deep sequencing MRD analysis of *NPM1* over

standard qPCR assays is the possibility to simultaneously analyze all recurrent insertion mutations. Consequently, NGS based MRD analysis of *NPM1* has been investigated in association with patient outcome.

Patkar *et al.* used NGS MRD to analyze *NPM1* during treatment (post-induction and post-consolidation) of AML and reported that MRD positivity (defined as  $<1 \log_{10}$  reduction between time points) was the most important independent prognostic factor predictive of OS. They showed a significant concordance between NGS MRD and qPCR for patients with *NPM1* type A mutation (136). In a study performed by Jongen-Lavrencic *et al.* an NGS targeted gene panel was used to monitor MRD in AML patients in CR for who at least 1 mutation were identified at diagnosis. The most frequently occurring mutation was in *NPM1* and they reported that persistent mutations in remission were associated with decreased RFS and OS (177). A Spanish group investigated the use of targeted deep sequencing MRD analysis in AML patients with *NPM1* insertions or SNVs in *FLT3*, *IDH1* and *IDH2* post-induction and post-consolidation. In this study, MRD  $>0.1\%$  post-induction was associated with significantly decreased OS, but significance was not reached for DFS. MRD levels  $>0.025\%$  post-consolidation was associated with both decreased OS and DFS. Survival analyses were also performed on *NPM1* and SNVs separately with similar results. In multivariable Cox analysis, increased age, *FLT3*-ITD, and MRD positivity were associated with higher risk of death. Only MRD positivity was associated with increased risk of relapse (189).

In paper III, we reported MRD positivity after alloHCT determined with deep sequencing of *NPM1* to be an independent predictor of relapse post-transplant. This result is in line with previous studies showing that MRD status post-transplant determined with MFC-MRD (86, 87) or RT-qPCR (25, 98) of *NPM1* is a strong predictor of relapse. Our finding is supported by Zhou *et al.* who analyzed *NPM1* using NGS MRD before and after alloHCT. That study showed that MRD positivity after alloHCT is associated with increased risk of relapse (190, 191).

## 5.6 ddPCR FOR ANALYSIS OF MRD

Another platform for high-sensitivity MRD analysis of somatic mutations is droplet digital PCR (ddPCR). This is a method that uses emulsion PCR for analysis of individual DNA molecules amplified in droplets. Using specific fluorescent probes for the wildtype and mutated target sequence, a digital (yes/no) signal is acquired from each droplet. This makes quantification possible without a need for calibration curves. Studies comparing MRD

results from ddPCR and RT-qPCR using either Ig/TCR rearrangements in ALL or *PML-RARA* transcripts in APL found concordant results for the two methods (192, 193). Regarding use of ddPCR MRD analysis for detection of patient-specific mutations in AML, Parkin *et al.* analyzed somatic mutations in CR and reported better 3-year RFS for patients achieving a reduction in mutation burden  $<0.01\%$  in CR than for those who did not (33% vs 81%) (194). Analysis of somatic mutations with ddPCR has also been investigated in circulating cell-free DNA after alloHCT in AML/MDS (median detection limit 0.04%) (186). Mutation persistence in serum one and three months after transplantation was associated with higher CIR, as was mutation persistence in matched BM samples. In this setting (post-alloHCT), also persistence of the preleukemic DTA mutations had prognostic effect on CIR. Mencia-Trinchant *et al.* explored a multiplex strategy for *NPM1* mutations for ddPCR MRD measurements, in an effort to broaden the applicability of the assay (195). A high sensitivity was reported. However, the number of *NPM1* mutations possible to multiplex in such an assay is limited and with higher background than for the type specific assays. MRD positivity before alloHCT as determined with ddPCR of *NPM1* (using multiple mutation specific probes) was shown by Bill *et al.* to be an independent negative prognostic marker in a cohort of 51 patients with adult AML with *NPM1* mutation (196).

## 5.7 MRD SURVEILLANCE AFTER END OF TREATMENT

RT-qPCR is only applicable for the fraction of AML patients with recurrent cytogenetic aberrations, whereas targeted deep sequencing using somatic mutations as MRD markers can be applied for the majority of patients. In paper II, we analyzed corresponding PB samples for patients who were determined MRD positive ( $<VAF^{EC} 5\%$ ) in BM and showed that mutations could be detected also in PB for all patients with  $VAF >0.1\%$  in BM. This suggested that deep sequencing also could be used to monitor PB, a notion that was extended in paper IV. In paper IV, we demonstrated the potential of patient-tailored targeted deep sequencing during follow-up. We could detect leukemia-specific mutations in PB before hematological relapse in almost all investigated patients. The first MRD positive sample preceded hematological relapse with a median of 90 days. This suggests that the methodology could be used for MRD surveillance after end of treatment for early detection of relapse and as a basis for studies on MRD guided preemptive treatment. Others have used RT-qPCR analysis of fusion transcripts or mutated *NPM1* for leukemia surveillance during follow-up and shown that molecular relapse heralds the hematological relapse (91, 103, 104, 168). Based on this, the ELN

has defined molecular relapse using RT-qPCR as one  $\log_{10}$  increase between two MRD positive samples in a patient who previously tested negative (64). When we applied the ELN definition described above to the nine relapsed patients included in paper IV, a one  $\log_{10}$  increase only occurred for one patient before hematological relapse. The window of detection is narrower for targeted deep sequencing than for RT-qPCR, specifically 3.25  $\log_{10}$  increases from the LOD of  $\text{VAF}^{\text{EC}}$  0.02% to the maximum theoretical  $\text{VAF}^{\text{EC}}$  of 50% for heterozygous mutations. A  $\text{VAF}^{\text{EC}}$  doubling between two MRD positive samples in a patient who previously tested negative occurred in 6/9 patients at a median of 80 days before hematological relapse and might be a more appropriate definition of molecular relapse in targeted deep sequencing MRD analysis. Relapse kinetics has been described using RT-qPCR for different subtypes of AML. For the few patients so far analyzed in paper IV, the MRD doubling time was similar to previous reports on fusion transcripts. In our study, two patients with *CBFB-MYH11* had a median doubling time of 28 days and two patients with *KMT2A*-rearrangements a median doubling time of 11 days. Ommen *et al.* reported median doubling times of 36 days for *CBFB-MYH11* and 12 days for *KMT2A*-rearrangements for RT-qPCR analyses of BM (103, 104).

In conclusion, targeted deep sequencing is a promising novel technique for MRD analysis in AML, enabling sensitive and personalized leukemia surveillance for patients currently lacking molecular markers for MRD.



## 6 CONCLUDING REMARKS & FUTURE PERSPECTIVES

As the landscapes of clonal heterogeneity and evolution of AML are unraveled, the suitability of different mutations as patient-specific MRD markers will become clearer. Already at this point it is clear that mutations in some genes are less suitable as MRD markers due to frequent loss during treatment (e.g. *FLT3*, *NRAS*, *KRAS*, *IDH1*, *IDH2*) or due to persistence in long-term remission (e.g. *DNMT3A*, *TET2*, *ASXL1*), whereas mutations in other genes are more suitable (e.g. *NPM1*). Exome-sequencing was performed on diagnostic and relapse samples in several of the included studies, with the objective to identify MRD-suitable patient-specific mutations in AML patients. These markers were chosen based on criteria that did not concern gene class or predicted pathological effect of the mutation. This data set can be further exploited in the future. Gene ontology analysis can be performed to investigate if gene mutations involved in certain pathways are more common at diagnosis and if mutations in some genes are more stable than others from diagnosis to relapse. The relative stability of predicted pathogenic mutations versus passenger mutations can also be explored. This can add information to the current literature on the MRD-suitability of different genes. Further, identified novel recurrent mutations can be tested in functional studies using *in vitro* or *in vivo* experimental setups.

The results from paper II suggested that targeted deep sequencing MRD analysis is more sensitive than MFC-MRD, but this needs to be confirmed in a larger patient material. An ongoing project within our research group therefore aims to evaluate if patient-tailored targeted deep sequencing is more sensitive and applicable than MFC for MRD assessment during treatment in childhood AML. Patient-tailored targeted deep sequencing will in this study be performed on samples from the three time points at which MFC-MRD analyses are performed in the NOPHO-DBH AML-2012 treatment protocol (day 22 after start of induction treatment, before start of the second induction course and before consolidation). The predictive value of the MRD results on outcome will be tested. If positive, targeted deep sequencing might qualify as a risk stratifying tool in a future version of the childhood AML trial protocol.

In paper III, we reported that targeted deep sequencing covers all recurrent insertions in exon 12 of the *NPM1* gene using a single assay. The RT-qPCR assay commonly used in clinical routine is specific for the *NPM1* type A



mutation. Due to the high degree of similarity between different *NPM1* insertions, the assay can detect presence of other insertion types, but it cannot be used for reliable MRD quantification. Targeted deep sequencing will therefore be highly suitable for molecular MRD analysis of patients with non-type A insertions in *NPM1*. Introduction of several different methods for patients with *NPM1* mutations calls for comparisons between methods, which is also ongoing in our group.

It has been reported that different subtypes of AML have very varying relapse kinetics, where the time from molecular relapse to hematological relapse ranged between a few weeks to several months. To be able to conduct studies on MRD guided preemptive treatment of early relapses using individualized molecular methods, the relapse kinetics of different mutation types need to be elucidated. In paper IV we describe how the relapse kinetics of patient-specific mutations vary between groups of patients with different cytogenetic aberrations. Before a new methodology can be used for monitoring, also patients who do not relapse need to be studied. Also, as ddPCR also has shown promise for assessment of mutation burden, use of both methods in parallel would be of interest. Both ddPCR and deep sequencing can be used for MRD analysis at the DNA level by determination of residual variant alleles, but it remains to be investigated how these methods compare. Likely they will be shown to be complementary tools. As the reagents for ddPCR are cheaper, it could serve as a cost-effective alternative for quantification of identified specific genetic lesions. Deep sequencing is more useful than ddPCR for quantification of mutations in hotspot regions in the genome, in cases where the mutated sequence frequently differ. In this setting one assay is sufficient using deep sequencing, whereas ddPCR would require multiple mutation specific probes, as previously described for exon 12 of the *NPM1* gene. Still, previously undescribed mutations would not be identified.

There is clear evidence that MRD is a strong and independent marker of prognosis in AML. In addition, there is retrospective data which suggests that MRD status surpasses the current principal predictors of outcome, *i.e.* mutational status. Studies on individualized molecular MRD analyses, performed by our and other research groups, have shown promising results. Such methods will enable sensitive MRD analysis for essentially all AML patients. Perhaps the now existing technologies for MRD analyses under optimized conditions are sufficient tools for determination of treatment response and surveillance in AML. When and how to test as well as how to act on the results however need to be clarified. To determine the full potential

of MRD directed therapy in AML, large randomized controlled trials for MRD based treatment strategies are necessary.

# ACKNOWLEDGEMENTS

Many people have in different ways contributed to the creation of this thesis.

First of all I would like to express my deepest gratitude to my main supervisor **Linda Fogelstrand**, for support, mentoring, inspiration and encouragement. For sharing your knowledge and passion for science. Always busy, but seldom too busy for a research discussion. Thank you! I look forward to continue working together.

Second, I would like to thank my co-supervisors:

**Lars Palmqvist** for valuable discussions and important advice on both clinical and experimental aspects of my research.

**Tore Samuelsson** for his essential bioinformatic expertise and ability to get things done fast. Retired? Maybe. But I know bioinformatics assistance is just an e-mail away!

I would also like to thank:

My present and former colleagues in Group Palmqvist/Fogelstrand:

**Giti Shah-Barkhordar** for great enthusiasm, support and excellent laboratory assistance.

**Christina “Tina” Nilsson** for being my go-to-person for laboratory related questions, for bringing optimism to the office and always offering a helping hand.

**Sara Ståhlman** for introducing me to the laboratory and the never too reliable FACS Aria.

**Susann Li** for great assistance in FACS-sorting and troubleshooting.

**Pegah Johansson** for laboratory assistance, encouragement and support.

**Julia Asp** for valuable scientific input and editing of manuscripts.

**Carina Wasslavik** for assistance with Sanger sequencing in the beginning of my studies.

My fellow PhD-students and PhD-students-to-be:

**Mathias Jerkfelt** for assistance with proof-reading of the thesis frame.

**Sofie Johansson Alm**, for bringing optimism to the lab as assistant (amanuens) and master student throughout my studies.

**Gustav Orrsjö**, for interesting discussions related to clinical practice, real estate purchases and parenting.

**Anastasia Soboli**, for assistance with FACS-sorting during my last hectic months of writing.

**Anders Östlund**, my intermittent office-neighbor, for interesting discussions and debriefing of mice experiments. Hope to see you back in the lab!

Our collaborators at Chalmers University of Technology, including **Anna Rehammar**, **Mariana Buongiorno Pereira & Erik Kristiansson** for fruitful collaboration and for taking me for a walk through the jungle of statistics. I would like to direct my deepest gratitude to Anna who has been an important and devoted collaborator in this work.

Our clinical collaborators including **Jonas Abrahamsson**, **Mats Brune**, **Hege Garelius**, **Mats Ehinger**, **Louise Pettersson**, **Vladimir Lazarevic & Stig Lenhoff**.

Our collaborators abroad, including **Henrik Hasle**, **Kristian Løvvik Juul-Dam & Anne-Sofie Skou** at the Aarhus University hospital, Denmark, and **Florian Kuchenbauer**, **Arefeh Rouhi**, **Edith Schneider & Nadine Sperb** at the University hospital of Ulm, Germany.

**Marcela Davila**, **Alvar Almstedt & Mathias Johansson** for bioinformatics assistance.

**Jennie Finnman**, **Stina Lassesson & Elham Rekabdar** at GeneCore SU (former Genomics Core Facility) for assistance and sharing of expertise in Next Generation Sequencing

**Anna Martner & Hanna Wiktorin Grauers** for collaboration and support in the endeavors of working with laboratory animals.

**Group Meena Kanduri**, including **Pradeep Kopparapu** and **Hamdy Mohammad Morsy** for interesting discussions on hematological malignancies.

**Henrik Svensson** for sharing his invaluable insights into the Basic Medicine PhD programme.

**Joakim Sandstedt** for valuable computer assistance.

**Susanne Teneberg & Eva Jennische** for guidance in higher education teaching and course development within the Basic Medicine PhD Programme.

**Karolina Sjöberg Jabbar & Susannah Castenbladh Leach** for great cooperation in the construction of an internet based teaching material.

The staff at the clinical laboratories at Sahlgrenska University Hospital for help with collecting and analyzing patient samples: **FACS-lab, benmärgslab, cytogenetik och genanalys.**

The funding sources for making this work possible: **Barncancerfonden, Kungliga och Hvitfeldtska stiftelsen, Lions Cancerfond Väst, Göteborgs Läkaresällskap, Sahlgrenska Universitetssjukhusets fonder, Stiftelsen Assar Gabrielssons Fond, and Wilhelm och Martina Lundgrens vetenskapsfond.**

My colleagues at the **Department of Clinical Pathology and Cytology**, Sahlgrenska University Hospital for being welcoming and flexible so that this thesis could be finished in time.

I would also like to express my sincere gratitude to the **University of Gothenburg** and the **Department of Laboratory Medicine** for the opportunity to pursue this work as an employee.

Finally, I would like to thank the people outside the academy and hospital that have supported me, mainly family and friends. There are some that I would like to especially mention.

Firstly, a huge thanks to my wonderful wife, **Christine Delsing Malmberg**, for your great support and extraordinary understanding of my tendency of working (“smygjobba”) a bit too much. You are, as well as our daughter **Ylva**, an infinite source of energy and joy. Love you to bits!



My dear parents, **Ulrica & Göran Malmberg**, without whom this thesis would never had been written (for more reasons than the obvious). Thank you for your constant support in everything I undertake! You are truly outstanding!



My dear sister, **Karin Wållgren**, who has also realized the appeal of cell biology. Thank you for support and encouragement! Friidaay!



My dear parents-in-law; **Désirée Delsing**, who cared for my daughter at times during my parental leave which enabled me to write, and **Per Delsing** for interesting scientific discussions, relaxing woodcutting and fine wine. Thank you!

My dear friend, **Kim Viggedal**, for “scientific discussion nights” and sharing his expertise of and practical skills in the science of alcoholic beverages.

Cheers mate!



## REFERENCES

1. Pesole G. What is a gene? An updated operational definition. *Gene* 2008;417:1-4.
2. Liu D, Keijzers G, Rasmussen LJ. DNA mismatch repair and its many roles in eukaryotic cells. *Mutation research* 2017;773:174-87.
3. Hanahan D, Weinberg RA. Hallmarks of cancer: The next generation. *Cell* 2011;144.
4. Juliusson G, Antunovic P, Derolf Å, Lehmann S, Möllgård L, Stockelberg D, et al. Age and acute myeloid leukemia: Real world data on decision to treat and outcomes from the swedish acute leukemia registry. *Blood* 2009;113:4179-87.
5. Deschler B, Lubbert M. Acute myeloid leukemia: Epidemiology and etiology. *Cancer* 2006;107:2099-107.
6. Abrahamsson J, Forestier E, Heldrup J, Jahnukainen K, Jonsson OG, Lausen B, et al. Response-guided induction therapy in pediatric acute myeloid leukemia with excellent remission rate. *Journal of clinical oncology : official journal of the American Society of Clinical Oncology* 2011;29:310-5.
7. Corces-Zimmerman MR, Hong WJ, Weissman IL, Medeiros BC, Majeti R. Preleukemic mutations in human acute myeloid leukemia affect epigenetic regulators and persist in remission. *Proceedings of the National Academy of Sciences of the United States of America* 2014;111:2548-53.
8. Jan M, Snyder TM, Corces-Zimmerman MR, Vyas P, Weissman IL, Quake SR, Majeti R. Clonal evolution of preleukemic hematopoietic stem cells precedes human acute myeloid leukemia. *Science translational medicine* 2012;4:149ra18.
9. Ugale A, Norddahl GL, Wahlestedt M, Sawen P, Jaako P, Pronk CJ, et al. Hematopoietic stem cells are intrinsically protected against mll-enl-mediated transformation. *Cell reports* 2014;9:1246-55.
10. Arber DA, Orazi A, Hasserjian R, Thiele J, Borowitz MJ, Le Beau MM, et al. The 2016 revision to the world health organization classification of myeloid neoplasms and acute leukemia. *Blood* 2016;127:2391-405.
11. Ley TJ, Miller C, Ding L, Raphael BJ, Mungall AJ, Robertson G, et al. Genomic and epigenomic landscapes of adult de novo acute myeloid leukemia. *New Engl J Med* 2013;368:2059-74.
12. Lawrence MS, Stojanov P, Polak P, Kryukov GV, Cibulskis K, Sivachenko A, et al. Mutational heterogeneity in cancer and the search for new cancer-associated genes. *Nature* 2013;499:214-8.

13. Grimwade D, Freeman SD. Defining minimal residual disease in acute myeloid leukemia: Which platforms are ready for "prime time"? *Blood* 2014;124:3345-55.
14. Creutzig U, Buchner T, Sauerland MC, Zimmermann M, Reinhardt D, Dohner H, Schlenk RF. Significance of age in acute myeloid leukemia patients younger than 30 years: A common analysis of the pediatric trials aml-bfm 93/98 and the adult trials amlcg 92/99 and amlsg hd93/98a. *Cancer* 2008;112:562-71.
15. Bolouri H, Farrar JE, Triche T, Jr., Ries RE, Lim EL, Alonzo TA, et al. The molecular landscape of pediatric acute myeloid leukemia reveals recurrent structural alterations and age-specific mutational interactions. *Nature medicine* 2018;24:103-12.
16. Gilliland DG, Griffin JD. The roles of *flt3* in hematopoiesis and leukemia. *Blood* 2002;100:1532-42.
17. Conway O'Brien E, Prideaux S. The epigenetic landscape of acute myeloid leukemia. 2014;2014:103175.
18. Kim T, Tyndel MS, Kim HJ, Ahn JS, Choi SH, Park HJ, et al. The clonal origins of leukemic progression of myelodysplasia. *Leukemia* 2017;31:1928-35.
19. Silva P, Neumann M, Schroeder MP, Vosberg S, Schlee C, Isaakidis K, et al. Acute myeloid leukemia in the elderly is characterized by a distinct genetic and epigenetic landscape. *Leukemia* 2017;31:1640-4.
20. Thol F, Bollin R, Gehlhaar M, Walter C, Dugas M, Suchanek KJ, et al. Mutations in the cohesin complex in acute myeloid leukemia: Clinical and prognostic implications. *Blood* 2014;123:914-20.
21. Thol F, Damm F, Wagner K, Gohring G, Schlegelberger B, Hoelzer D, et al. Prognostic impact of *idh2* mutations in cytogenetically normal acute myeloid leukemia. *Blood* 2010;116:614-6.
22. Yoshida K, Sanada M, Shiraishi Y, Nowak D, Nagata Y, Yamamoto R, et al. Frequent pathway mutations of splicing machinery in myelodysplasia. *Nature* 2011;478:64-9.
23. Lindstrom MS. *Npm1/b23*: A multifunctional chaperone in ribosome biogenesis and chromatin remodeling. *Biochemistry research international* 2011;2011:195209.
24. Thiede C, Koch S, Creutzig E, Steudel C, Illmer T, Schaich M, Ehninger G. Prevalence and prognostic impact of *npml* mutations in 1485 adult patients with acute myeloid leukemia (aml). *Blood* 2006;107:4011-20.
25. Shayegi N, Kramer M, Bornhauser M, Schaich M, Schetelig J, Platzbecker U, et al. The level of residual disease based on mutant *npml* is an independent prognostic factor for relapse and survival in aml. *Blood* 2013;122:83-92.
26. Daver N, Schlenk RF, Russell NH, Levis MJ. Targeting *flt3* mutations in aml: Review of current knowledge and evidence. *Leukemia* 2019;33:299-312.



27. Kikushige Y, Yoshimoto G, Miyamoto T, Iino T, Mori Y, Iwasaki H, et al. Human *flt3* is expressed at the hematopoietic stem cell and the granulocyte/macrophage progenitor stages to maintain cell survival. *Journal of immunology* (Baltimore, Md : 1950) 2008;180:7358-67.
28. Grafone T, Palmisano M, Nicci C, Storti S. An overview on the role of *flt3*-tyrosine kinase receptor in acute myeloid leukemia: Biology and treatment. *Oncology reviews* 2012;6:e8.
29. Meshinchi S, Alonzo TA, Stirewalt DL, Zwaan M, Zimmerman M, Reinhardt D, et al. Clinical implications of *flt3* mutations in pediatric aml. *Blood* 2006;108:3654-61.
30. Thiede C, Steudel C, Mohr B, Schaich M, Schakel U, Platzbecker U, et al. Analysis of *flt3*-activating mutations in 979 patients with acute myelogenous leukemia: Association with fab subtypes and identification of subgroups with poor prognosis. *Blood* 2002;99:4326-35.
31. Pratcorona M, Brunet S, Nomdedeu J, Ribera JM, Tormo M, Duarte R, et al. Favorable outcome of patients with acute myeloid leukemia harboring a low-allelic burden *flt3*-itd mutation and concomitant *npml* mutation: Relevance to post-remission therapy. *Blood* 2013;121:2734-8.
32. Sakaguchi M, Yamaguchi H, Najima Y, Usuki K, Ueki T, Oh I, et al. Prognostic impact of low allelic ratio *flt3*-itd and *npml* mutation in acute myeloid leukemia. *Blood advances* 2018;2:2744-54.
33. Baer MR, Stewart CC, Lawrence D, Arthur DC, Mrozek K, Strout MP, et al. Acute myeloid leukemia with 11q23 translocations: Myelomonocytic immunophenotype by multiparameter flow cytometry. *Leukemia* 1998;12:317-25.
34. Meyer C, Hofmann J, Burmeister T, Groger D, Park TS, Emerenciano M, et al. The *mll* recombinome of acute leukemias in 2013. *Leukemia* 2013;27:2165-76.
35. Winters AC, Bernt KM. *Mll*-rearranged leukemias-an update on science and clinical approaches. *Frontiers in pediatrics* 2017;5:4.
36. Balgobind BV, Raimondi SC, Harbott J, Zimmermann M, Alonzo TA, Auvrignon A, et al. Novel prognostic subgroups in childhood 11q23/*mll*-rearranged acute myeloid leukemia: Results of an international retrospective study. *Blood* 2009;114:2489-96.
37. Solh M, Yohe S, Weisdorf D, Ustun C. Core-binding factor acute myeloid leukemia: Heterogeneity, monitoring, and therapy. *Am J Hematol* 2014;89:1121-31.
38. Hatlen MA, Wang L, Nimer SD. *Aml1*-eto driven acute leukemia: Insights into pathogenesis and potential therapeutic approaches. *Frontiers of medicine* 2012;6:248-62.
39. Adya N, Stacy T, Speck NA, Liu PP. The leukemic protein core binding factor beta (*cbfbeta*)-smooth-muscle myosin heavy chain

- sequesters cbfalpha2 into cytoskeletal filaments and aggregates. *Molecular and cellular biology* 1998;18:7432-43.
40. Desai P, Mencia-Trinchant N, Savenkov O, Simon MS, Cheang G, Lee S, et al. Somatic mutations predict acute myeloid leukemia years before diagnosis. *bioRxiv* 2017:237941.
  41. Abelson S, Collord G, Ng SWK, Weissbrod O, Mendelson Cohen N, Niemeyer E, et al. Prediction of acute myeloid leukaemia risk in healthy individuals. *Nature* 2018.
  42. McKerrell T, Park N, Moreno T, Grove CS, Ponstingl H, Stephens J, et al. Leukemia-associated somatic mutations drive distinct patterns of age-related clonal hemopoiesis. *Cell reports* 2015;10:1239-45.
  43. Kronke J, Bullinger L, Teleanu V, Tschurtz F, Gaidzik VI, Kuhn MW, et al. Clonal evolution in relapsed npml1-mutated acute myeloid leukemia. *Blood* 2013;122:100-8.
  44. Brambati C, Galbiati S, Xue E, Toffalori C, Crucitti L, Greco R, et al. Droplet digital polymerase chain reaction for dnmt3a and idh1/2 mutations to improve early detection of acute myeloid leukemia relapse after allogeneic hematopoietic stem cell transplantation. *Haematologica* 2016;101:e157-61.
  45. Ploen GG, Nederby L, Guldberg P, Hansen M, Ebbesen LH, Jensen UB, et al. Persistence of dnmt3a mutations at long-term remission in adult patients with aml. *British journal of haematology* 2014;167:478-86.
  46. Debarri H, Lebon D, Roumier C, Cheok M, Marceau-Renaut A, Nibourel O, et al. Idh1/2 but not dnmt3a mutations are suitable targets for minimal residual disease monitoring in acute myeloid leukemia patients: A study by the acute leukemia french association. *Oncotarget* 2015;6:42345-53.
  47. Dohner H, Estey E, Grimwade D, Amadori S, Appelbaum FR, Buchner T, et al. Diagnosis and management of aml in adults: 2017 eln recommendations from an international expert panel. *Blood* 2017;129:424-47.
  48. Fernandez HF, Sun Z, Yao X, Litzow MR, Luger SM, Paietta EM, et al. Anthracycline dose intensification in acute myeloid leukemia. *The New England journal of medicine* 2009;361:1249-59.
  49. Burnett AK, Hills RK, Milligan D, Hunter AE, Goldstone AH, Prentice A, et al. Attempts to optimise induction and consolidation chemotherapy in patients with acute myeloid leukaemia: Results of the mrc aml15 trial. Vol.: *Am Soc Hematology*, 2009.
  50. Stone RM, O'Donnell MR, Sekeres MA. Acute myeloid leukemia. *Hematology / the Education Program of the American Society of Hematology American Society of Hematology Education Program* 2004:98-117.
  51. Wheatley K, Burnett AK, Goldstone AH, Gray RG, Hann IM, Harrison CJ, et al. A simple, robust, validated and highly predictive

- index for the determination of risk-directed therapy in acute myeloid leukaemia derived from the mrc aml 10 trial. *British journal of haematology* 1999;107:69-79.
52. Kern W, Voskova D, Schoch C, Hiddemann W, Schnittger S, Haferlach T. Determination of relapse risk based on assessment of minimal residual disease during complete remission by multiparameter flow cytometry in unselected patients with acute myeloid leukemia. *Blood* 2004;104:3078-85.
  53. San Miguel JF, Vidriales MB, Lopez-Berges C, Diaz-Mediavilla J, Gutierrez N, Canizo C, et al. Early immunophenotypical evaluation of minimal residual disease in acute myeloid leukemia identifies different patient risk groups and may contribute to postinduction treatment stratification. *Blood* 2001;98:1746-51.
  54. Hulegårdh E, Nilsson C, Lazarevic V, Garelius H, Antunovic P, Rangert Derolf Å, et al. Characterization and prognostic features of secondary acute myeloid leukemia in a population-based setting: A report from the swedish acute leukemia registry. *American journal of hematology* 2015;90:208-14.
  55. Kayser S, Dohner K, Krauter J, Kohne CH, Horst HA, Held G, et al. The impact of therapy-related acute myeloid leukemia (aml) on outcome in 2853 adult patients with newly diagnosed aml. *Blood* 2011;117:2137-45.
  56. Larson RA. Is secondary leukemia an independent poor prognostic factor in acute myeloid leukemia? *Best practice & research Clinical haematology* 2007;20:29-37.
  57. Schoch C, Kern W, Schnittger S, Buchner T, Hiddemann W, Haferlach T. The influence of age on prognosis of de novo acute myeloid leukemia differs according to cytogenetic subgroups. *Haematologica* 2004;89:1082-90.
  58. Appelbaum FR, Gundacker H, Head DR, Slovak ML, Willman CL, Godwin JE, et al. Age and acute myeloid leukemia. *Blood* 2006;107:3481-5.
  59. Creutzig U, van den Heuvel-Eibrink MM, Gibson B, Dworzak MN, Adachi S, de Bont E, et al. Diagnosis and management of acute myeloid leukemia in children and adolescents: Recommendations from an international expert panel. *Blood* 2012;120:3187-205.
  60. Tierens A, Bjorklund E, Siitonen S, Marquart HV, Wulff-Juergensen G, Pelliniemi TT, et al. Residual disease detected by flow cytometry is an independent predictor of survival in childhood acute myeloid leukaemia; results of the nopho-aml 2004 study. *British journal of haematology* 2016;174:600-9.
  61. Schnittger S, Kern W, Tschulik C, Weiss T, Dicker F, Falini B, et al. Minimal residual disease levels assessed by npml mutation-specific rq-pcr provide important prognostic information in aml. *Blood* 2009;114:2220-31.

62. Kalina T, Flores-Montero J, van der Velden VH, Martin-Ayuso M, Bottcher S, Ritgen M, et al. Euroflow standardization of flow cytometer instrument settings and immunophenotyping protocols. *Leukemia* 2012;26:1986-2010.
63. van Dongen JJ, Lhermitte L, Bottcher S, Almeida J, van der Velden VH, Flores-Montero J, et al. Euroflow antibody panels for standardized n-dimensional flow cytometric immunophenotyping of normal, reactive and malignant leukocytes. *Leukemia* 2012;26:1908-75.
64. Schuurhuis GJ, Heuser M, Freeman S, Bene MC, Buccisano F, Cloos J, et al. Minimal/measurable residual disease in aml: Consensus document from eln mrd working party. *Blood* 2018.
65. Gabert J, Beillard E, van der Velden VH, Bi W, Grimwade D, Pallisgaard N, et al. Standardization and quality control studies of 'real-time' quantitative reverse transcriptase polymerase chain reaction of fusion gene transcripts for residual disease detection in leukemia - a europe against cancer program. *Leukemia* 2003;17:2318-57.
66. Grimwade D, Jovanovic JV, Hills RK, Nugent EA, Patel Y, Flora R, et al. Prospective minimal residual disease monitoring to predict relapse of acute promyelocytic leukemia and to direct pre-emptive arsenic trioxide therapy. *Journal of clinical oncology : official journal of the American Society of Clinical Oncology* 2009;27:3650-8.
67. Baccarani M, Deininger MW, Rosti G, Hochhaus A, Soverini S, Apperley JF, et al. European leukemianet recommendations for the management of chronic myeloid leukemia: 2013. *Blood* 2013;122:872-84.
68. van Dongen JJ, van der Velden VH, Brüggemann M, Orfao A. Minimal residual disease diagnostics in acute lymphoblastic leukemia: Need for sensitive, fast, and standardized technologies. *Blood* 2015;125:3996-4009.
69. Conter V, Bartram CR, Valsecchi MG, Schrauder A, Panzer-Grumayer R, Moricke A, et al. Molecular response to treatment redefines all prognostic factors in children and adolescents with b-cell precursor acute lymphoblastic leukemia: Results in 3184 patients of the aieop-bfm all 2000 study. *Blood* 2010;115:3206-14.
70. Schrappe M, Valsecchi MG, Bartram CR, Schrauder A, Panzer-Grumayer R, Moricke A, et al. Late mrd response determines relapse risk overall and in subsets of childhood t-cell all: Results of the aieop-bfm-all 2000 study. *Blood* 2011;118:2077-84.
71. Brüggemann M, Raff T, Flohr T, Gokbuget N, Nakao M, Droese J, et al. Clinical significance of minimal residual disease quantification in adult patients with standard-risk acute lymphoblastic leukemia. *Blood* 2006;107:1116-23.

72. Bassan R, Spinelli O, Oldani E, Intermesoli T, Tosi M, Peruta B, et al. Improved risk classification for risk-specific therapy based on the molecular study of minimal residual disease (mrd) in adult acute lymphoblastic leukemia (all). *Blood* 2009;113:4153-62.
73. Gokbuget N, Kneba M, Raff T, Trautmann H, Bartram CR, Arnold R, et al. Adult patients with acute lymphoblastic leukemia and molecular failure display a poor prognosis and are candidates for stem cell transplantation and targeted therapies. *Blood* 2012;120:1868-76.
74. Vora A, Goulden N, Wade R, Mitchell C, Hancock J, Hough R, et al. Treatment reduction for children and young adults with low-risk acute lymphoblastic leukaemia defined by minimal residual disease (ukall 2003): A randomised controlled trial. *The Lancet Oncology* 2013;14:199-209.
75. Eckert C, Henze G, Seeger K, Hagedorn N, Mann G, Panzer-Grumayer R, et al. Use of allogeneic hematopoietic stem-cell transplantation based on minimal residual disease response improves outcomes for children with relapsed acute lymphoblastic leukemia in the intermediate-risk group. *Journal of clinical oncology : official journal of the American Society of Clinical Oncology* 2013;31:2736-42.
76. Toft N, Birgens H, Abrahamsson J, Griskevicius L, Hallbook H, Heyman M, et al. Results of nopho all2008 treatment for patients aged 1-45 years with acute lymphoblastic leukemia. *Leukemia* 2018;32:606-15.
77. Modvig S, Madsen HO, Siitonen SM, Rosthoj S, Tierens A, Juvonen V, et al. Minimal residual disease quantification by flow cytometry provides reliable risk stratification in t-cell acute lymphoblastic leukemia. *Leukemia* 2018.
78. Sanz MA, Grimwade D, Tallman MS, Lowenberg B, Fenaux P, Estey EH, et al. Management of acute promyelocytic leukemia: Recommendations from an expert panel on behalf of the european leukemianet. *Blood* 2009;113:1875-91.
79. Terwijn M, van Putten WL, Kelder A, van der Velden VH, Brooimans RA, Pabst T, et al. High prognostic impact of flow cytometric minimal residual disease detection in acute myeloid leukemia: Data from the hovan/sakk aml 42a study. *Journal of clinical oncology : official journal of the American Society of Clinical Oncology* 2013;31:3889-97.
80. Freeman SD, Virgo P, Couzens S, Grimwade D, Russell N, Hills RK, Burnett AK. Prognostic relevance of treatment response measured by flow cytometric residual disease detection in older patients with acute myeloid leukemia. *Journal of clinical oncology : official journal of the American Society of Clinical Oncology* 2013;31:4123-31.

81. Ossenkoppele GJ, Schuurhuis GJ. Mrd in aml: It is time to change the definition of remission. Best practice & research Clinical haematology 2014;27:265-71.
82. Inaba H, Coustan-Smith E, Cao X, Pounds SB, Shurtleff SA, Wang KY, et al. Comparative analysis of different approaches to measure treatment response in acute myeloid leukemia. Journal of clinical oncology : official journal of the American Society of Clinical Oncology 2012;30:3625-32.
83. Rubnitz JE, Inaba H, Dahl G, Ribeiro RC, Bowman WP, Taub J, et al. Minimal residual disease-directed therapy for childhood acute myeloid leukaemia: Results of the aml02 multicentre trial. The Lancet Oncology 2010;11:543-52.
84. van der Velden VH, van der Sluijs-Geling A, Gibson BE, te Marvelde JG, Hoogeveen PG, Hop WC, et al. Clinical significance of flowcytometric minimal residual disease detection in pediatric acute myeloid leukemia patients treated according to the dcog anl197/mrc aml12 protocol. Leukemia 2010;24:1599-606.
85. Walter RB, Gooley TA, Wood BL, Milano F, Fang M, Sorrow ML, et al. Impact of pretransplantation minimal residual disease, as detected by multiparametric flow cytometry, on outcome of myeloablative hematopoietic cell transplantation for acute myeloid leukemia. Journal of clinical oncology : official journal of the American Society of Clinical Oncology 2011;29:1190-7.
86. Bastos-Oreiro M, Perez-Corral A, Martinez-Laperche C, Bento L, Pascual C, Kwon M, et al. Prognostic impact of minimal residual disease analysis by flow cytometry in patients with acute myeloid leukemia before and after allogeneic hemopoietic stem cell transplantation. Eur J Haematol 2014;93:239-46.
87. Zhou Y, Othus M, Araki D, Wood BL, Radich JP, Halpern AB, et al. Pre- and post-transplant quantification of measurable ('minimal') residual disease via multiparameter flow cytometry in adult acute myeloid leukemia. Leukemia 2016;30:1456-64.
88. Weisser M, Haferlach C, Hiddemann W, Schnittger S. The quality of molecular response to chemotherapy is predictive for the outcome of aml1-eto-positive aml and is independent of pretreatment risk factors. Leukemia 2007;21:1177-82.
89. Corbacioglu A, Scholl C, Schlenk RF, Eiwen K, Du J, Bullinger L, et al. Prognostic impact of minimal residual disease in cbfb-myh11-positive acute myeloid leukemia. Journal of clinical oncology : official journal of the American Society of Clinical Oncology 2010;28:3724-9.
90. Scholl C, Schlenk RF, Eiwen K, Dohner H, Frohling S, Dohner K. The prognostic value of mll-af9 detection in patients with t(9;11)(p22;q23)-positive acute myeloid leukemia. Haematologica 2005;90:1626-34.



91. Ivey A, Hills RK, Simpson MA, Jovanovic JV, Gilkes A, Grech A, et al. Assessment of minimal residual disease in standard-risk aml. *The New England journal of medicine* 2016;374:422-33.
92. Rucker FG, Agrawal M, Corbacioglu A, Weber D, Kapp-Schworer S, Gaidzik VI, et al. Measurable residual disease monitoring in acute myeloid leukemia with t(8;21)(q22;q22.1): Results of the aml study group. *Blood* 2019.
93. Wang Y, Wu DP, Liu QF, Qin YZ, Wang JB, Xu LP, et al. In adults with t(8;21)aml, posttransplant runx1/runx1t1-based mrd monitoring, rather than c-kit mutations, allows further risk stratification. *Blood* 2014;124:1880-6.
94. Elmaagacli AH, Beelen DW, Kroll M, Trzinsky S, Stein C, Schaefer UW. Detection of cbfbeta/myh11 fusion transcripts in patients with inv(16) acute myeloid leukemia after allogeneic bone marrow or peripheral blood progenitor cell transplantation. *Bone marrow transplantation* 1998;21:159-66.
95. Dulery R, Nibourel O, Gauthier J, Elsermans V, Behal H, Coiteux V, et al. Impact of wilms' tumor 1 expression on outcome of patients undergoing allogeneic stem cell transplantation for aml. *Bone marrow transplantation* 2017.
96. Jacobsohn DA, Tse WT, Chaleff S, Rademaker A, Duerst R, Olszewski M, et al. High wt1 gene expression before haematopoietic stem cell transplant in children with acute myeloid leukaemia predicts poor event-free survival. *British journal of haematology* 2009;146:669-74.
97. Kayser S, Benner A, Thiede C, Martens U, Huber J, Stadtherr P, et al. Pretransplant npml mrd levels predict outcome after allogeneic hematopoietic stem cell transplantation in patients with acute myeloid leukemia. *Blood cancer journal* 2016;6:e449.
98. Bacher U, Badbaran A, Fehse B, Zabelina T, Zander AR, Kroger N. Quantitative monitoring of npml mutations provides a valid minimal residual disease parameter following allogeneic stem cell transplantation. *Experimental hematology* 2009;37:135-42.
99. Zhu HH, Zhang XH, Qin YZ, Liu DH, Jiang H, Chen H, et al. Mrd-directed risk stratification treatment may improve outcomes of t(8;21) aml in the first complete remission: Results from the aml05 multicenter trial. *Blood* 2013;121:4056-62.
100. Qin YZ, Xu LP, Chen H, Jiang Q, Wang Y, Jiang H, et al. Allogeneic stem cell transplant may improve the outcome of adult patients with inv(16) acute myeloid leukemia in first complete remission with poor molecular responses to chemotherapy. *Leukemia & lymphoma* 2015;56:3116-23.
101. Balsat M, Renneville A, Thomas X, de Botton S, Caillot D, Marceau A, et al. Postinduction minimal residual disease predicts outcome and benefit from allogeneic stem cell transplantation in acute myeloid

- leukemia with *npml* mutation: A study by the acute leukemia french association group. *Journal of clinical oncology : official journal of the American Society of Clinical Oncology* 2017;35:185-93.
102. Buccisano F, Maurillo L, Spagnoli A, Del Principe MI, Fraboni D, Panetta P, et al. Cytogenetic and molecular diagnostic characterization combined to postconsolidation minimal residual disease assessment by flow cytometry improves risk stratification in adult acute myeloid leukemia. *Blood* 2010;116:2295-303.
  103. Ommen HB, Schnittger S, Jovanovic JV, Ommen IB, Hasle H, Ostergaard M, et al. Strikingly different molecular relapse kinetics in *npmlc*, *pml-rara*, *runx1-runx1t1*, and *cbfb-myh11* acute myeloid leukemias. *Blood* 2010;115:198-205.
  104. Ommen HB, Hokland P, Haferlach T, Abildgaard L, Alpermann T, Haferlach C, et al. Relapse kinetics in acute myeloid leukaemias with *mll* translocations or partial tandem duplications within the *mll* gene. *British journal of haematology* 2014;165:618-28.
  105. Doubek M, Palasek I, Pospisil Z, Borsky M, Klabusay M, Brychtova Y, et al. Detection and treatment of molecular relapse in acute myeloid leukemia with *runx1 (aml1)*, *cbfb*, or *mll* gene translocations: Frequent quantitative monitoring of molecular markers in different compartments and correlation with *wt1* gene expression. *Experimental hematology* 2009;37:659-72.
  106. Sockel K, Wermke M, Radke J, Kiani A, Schaich M, Bornhauser M, et al. Minimal residual disease-directed preemptive treatment with azacitidine in patients with *npml*-mutant acute myeloid leukemia and molecular relapse. *Haematologica* 2011;96:1568-70.
  107. Platzbecker U, Wermke M, Radke J, Oelschlaegel U, Seltsmann F, Kiani A, et al. Azacitidine for treatment of imminent relapse in mds or aml patients after allogeneic hsct: Results of the relaza trial. *Leukemia* 2012;26:381-9.
  108. Platzbecker U, Middeke JM, Sockel K, Herbst R, Wolf D, Baldus CD, et al. Measurable residual disease-guided treatment with azacitidine to prevent haematological relapse in patients with myelodysplastic syndrome and acute myeloid leukaemia (relaza2): An open-label, multicentre, phase 2 trial. *The Lancet Oncology* 2018;19:1668-79.
  109. Pozzi S, Geroldi S, Tedone E, Luchetti S, Grasso R, Colombo N, et al. Leukaemia relapse after allogeneic transplants for acute myeloid leukaemia: Predictive role of *wt1* expression. *British journal of haematology* 2013;160:503-9.
  110. Venditti A, Buccisano F, Del Poeta G, Maurillo L, Tamburini A, Cox C, et al. Level of minimal residual disease after consolidation therapy predicts outcome in acute myeloid leukemia. *Blood* 2000;96:3948-52.



111. San Miguel JF, Martinez A, Macedo A, Vidriales MB, Lopez-Berges C, Gonzalez M, et al. Immunophenotyping investigation of minimal residual disease is a useful approach for predicting relapse in acute myeloid leukemia patients. *Blood* 1997;90:2465-70.
112. Maurillo L, Buccisano F, Del Principe MI, Del Poeta G, Spagnoli A, Panetta P, et al. Toward optimization of postremission therapy for residual disease-positive patients with acute myeloid leukemia. *Journal of clinical oncology : official journal of the American Society of Clinical Oncology* 2008;26:4944-51.
113. Voskova D, Schoch C, Schnittger S, Hiddemann W, Haferlach T, Kern W. Stability of leukemia-associated aberrant immunophenotypes in patients with acute myeloid leukemia between diagnosis and relapse: Comparison with cytomorphicologic, cytogenetic, and molecular genetic findings. *Cytometry Part B, Clinical cytometry* 2004;62:25-38.
114. Baer MR, Stewart CC, Dodge RK, Leget G, Sule N, Mrozek K, et al. High frequency of immunophenotype changes in acute myeloid leukemia at relapse: Implications for residual disease detection (cancer and leukemia group b study 8361). *Blood* 2001;97:3574-80.
115. Langebrake C, Brinkmann I, Teigler-Schlegel A, Creutzig U, Griesinger F, Puhlmann U, Reinhardt D. Immunophenotypic differences between diagnosis and relapse in childhood aml: Implications for mrd monitoring. *Cytometry Part B, Clinical cytometry* 2005;63:1-9.
116. Welch JS, Ley TJ, Link DC, Miller CA, Larson DE, Koboldt DC, et al. The origin and evolution of mutations in acute myeloid leukemia. *Cell* 2012;150:264-78.
117. Ojames PN, Kontro M, Edgren H, Ellonen P, Heckman C, Porkka K, et al. Case studies investigating genetic heterogeneity between anatomically distinct bone marrow compartments in acute myeloid leukemia. *Leukemia & lymphoma* 2018;59:3002-5.
118. Ding L, Ley TJ, Larson DE, Miller CA, Koboldt DC, Welch JS, et al. Clonal evolution in relapsed acute myeloid leukaemia revealed by whole-genome sequencing. *Nature* 2012;481:506-10.
119. Suzuki T, Kiyoi H, Ozeki K, Tomita A, Yamaji S, Suzuki R, et al. Clinical characteristics and prognostic implications of npml mutations in acute myeloid leukemia. *Blood* 2005;106:2854-61.
120. Chou WC, Tang JL, Lin LI, Yao M, Tsay W, Chen CY, et al. Nucleophosmin mutations in de novo acute myeloid leukemia: The age-dependent incidences and the stability during disease evolution. *Cancer research* 2006;66:3310-6.
121. Li S, Garrett-Bakelman FE, Chung SS, Sanders MA, Hricik T, Rapaport F, et al. Distinct evolution and dynamics of epigenetic and genetic heterogeneity in acute myeloid leukemia. *Nature medicine* 2016;22:792-9.

122. Xie M, Lu C, Wang J, McLellan MD, Johnson KJ, Wendl MC, et al. Age-related mutations associated with clonal hematopoietic expansion and malignancies. *Nature medicine* 2014;20:1472-8.
123. Jaiswal S, Fontanillas P, Flannick J, Manning A, Grauman PV, Mar BG, et al. Age-related clonal hematopoiesis associated with adverse outcomes. *The New England journal of medicine* 2014;371:2488-98.
124. Steensma DP, Bejar R, Jaiswal S, Lindsley RC, Sekeres MA, Hasserjian RP, Ebert BL. Clonal hematopoiesis of indeterminate potential and its distinction from myelodysplastic syndromes. *Blood* 2015;126:9-16.
125. Verma D, Kantarjian H, Faderl S, O'Brien S, Pierce S, Vu K, et al. Late relapses in acute myeloid leukemia: Analysis of characteristics and outcome. *Leukemia & lymphoma* 2010;51:778-82.
126. Bejanyan N, Weisdorf DJ, Logan BR, Wang HL, Devine SM, de Lima M, et al. Survival of patients with acute myeloid leukemia relapsing after allogeneic hematopoietic cell transplantation: A center for international blood and marrow transplant research study. *Biology of blood and marrow transplantation : journal of the American Society for Blood and Marrow Transplantation* 2015;21:454-9.
127. Weltermann A, Fonatsch C, Haas OA, Greinix HT, Kahls P, Mitterbauer G, et al. Impact of cytogenetics on the prognosis of adults with de novo aml in first relapse. *Leukemia* 2004;18:293-302.
128. Devillier R, Crocchiolo R, Etienne A, Prebet T, Charbonnier A, Fürst S, et al. Outcome of relapse after allogeneic stem cell transplant in patients with acute myeloid leukemia. *Leukemia & lymphoma* 2013;54:1228-34.
129. Karlsson L, Forestier E, Hasle H, Jahnukainen K, Jonsson OG, Lausen B, et al. Outcome after intensive reinduction therapy and allogeneic stem cell transplant in paediatric relapsed acute myeloid leukaemia. *British journal of haematology* 2017;178:592-602.
130. Lane S, Saal R, Mollee P, Jones M, Grigg A, Taylor K, et al. A  $\geq 1$  log rise in rq-pcr transcript levels defines molecular relapse in core binding factor acute myeloid leukemia and predicts subsequent morphologic relapse. *Leukemia & lymphoma* 2008;49:517-23.
131. Ommen HB. Monitoring minimal residual disease in acute myeloid leukaemia: A review of the current evolving strategies. *Therapeutic advances in hematology* 2016;7:3-16.
132. Salipante SJ, Fromm JR, Shendure J, Wood BL, Wu D. Detection of minimal residual disease in npml1-mutated acute myeloid leukemia by next-generation sequencing. *Modern pathology : an official journal of the United States and Canadian Academy of Pathology, Inc* 2014.
133. Thol F, Kolking B, Damm F, Reinhardt K, Klusmann JH, Reinhardt D, et al. Next-generation sequencing for minimal residual disease

- monitoring in acute myeloid leukemia patients with *flt3-itd* or *npml* mutations. *Genes, chromosomes & cancer* 2012;51:689-95.
134. Kohlmann A, Nadarajah N, Alpermann T, Grossmann V, Schindela S, Dicker F, et al. Monitoring of residual disease by next-generation deep-sequencing of *runx1* mutations can identify acute myeloid leukemia patients with resistant disease. *Leukemia* 2014;28:129-37.
  135. Thol F, Gabdoulline R, Liebich A, Klement P, Schiller J, Kandziora C, et al. Measurable residual disease (mrd) monitoring by ngs before allogeneic hematopoietic cell transplantation in aml. *Blood* 2018:blood-2018-02-829911.
  136. Patkar N, Kodgule R, Kakirde C, Raval G, Bhanshe P, Joshi S, et al. Clinical impact of measurable residual disease monitoring by ultradeep next generation sequencing in *npml* mutated acute myeloid leukemia. *Oncotarget* 2018;9:36613-24.
  137. Hirsch P, Tang R, Abermil N, Flandrin P, Moatti H, Favale F, et al. Precision and prognostic value of clone-specific minimal residual disease in acute myeloid leukemia. *Haematologica* 2017;102:1227-37.
  138. Blombery P, Jones K, Doig K, Ryland G, McBean M, Thompson E, et al. Sensitive *npml* mutation quantitation in acute myeloid leukemia using ultradeep next-generation sequencing in the diagnostic laboratory. *Archives of pathology & laboratory medicine* 2018.
  139. Klco JM, Miller CA, Griffith M, Petti A, Spencer DH, Ketkar-Kulkarni S, et al. Association between mutation clearance after induction therapy and outcomes in acute myeloid leukemia. *Jama* 2015;314:811-22.
  140. Malmberg EB, Ståhlman S, Rehammar A, Samuelsson T, Alm SJ, Kristiansson E, et al. Patient-tailored analysis of minimal residual disease in acute myeloid leukemia using next-generation sequencing. *European journal of haematology* 2017;98:26-37.
  141. Malmberg ED, Rehammar A, Pereira MB, Abrahamsson J, Samuelsson T, Ståhlman S, et al. Accurate and sensitive analysis of minimal residual disease in acute myeloid leukemia using deep sequencing of single nucleotide variations. *The Journal of Molecular Diagnostics* 2018.
  142. Li H, Durbin R. Fast and accurate short read alignment with burrows-wheeler transform. *Bioinformatics* 2009;25:1754-60.
  143. Cibulskis K, Lawrence MS, Carter SL, Sivachenko A, Jaffe D, Sougnez C, et al. Sensitive detection of somatic point mutations in impure and heterogeneous cancer samples. *Nature biotechnology* 2013;31:213-9.
  144. Saunders CT, Wong WS, Swamy S, Becq J, Murray LJ, Cheetham RK. Strelka: Accurate somatic small-variant calling from sequenced tumor-normal sample pairs. *Bioinformatics* 2012;28:1811-7.

145. Koboldt DC, Zhang Q, Larson DE, Shen D, McLellan MD, Lin L, et al. VarScan 2: Somatic mutation and copy number alteration discovery in cancer by exome sequencing. *Genome research* 2012;22:568-76.
146. Zhang J, Kobert K, Flouri T, Stamatakis A. Pear: A fast and accurate illumina paired-end read merger. *Bioinformatics* 2014;30:614-20.
147. Schirmer M, Ijaz UZ, D'Amore R, Hall N, Sloan WT, Quince C. Insight into biases and sequencing errors for amplicon sequencing with the illumina miseq platform. *Nucleic acids research* 2015;43:e37.
148. Nakamura K, Oshima T, Morimoto T, Ikeda S, Yoshikawa H, Shiwa Y, et al. Sequence-specific error profile of illumina sequencers. *Nucleic acids research* 2011:gkr344.
149. Tang X, Alatrash G, Ning J, Jakher H, Stafford P, Zope M, et al. Increasing chimerism after allogeneic stem cell transplantation is associated with longer survival time. *Biology of blood and marrow transplantation : journal of the American Society for Blood and Marrow Transplantation* 2014;20:1139-44.
150. Bader P, Kreyenberg H, Hoelle W, Dueckers G, Kremens B, Dilloo D, et al. Increasing mixed chimerism defines a high-risk group of childhood acute myelogenous leukemia patients after allogeneic stem cell transplantation where pre-emptive immunotherapy may be effective. *Bone marrow transplantation* 2004;33:815-21.
151. Falini B, Mecucci C, Tiacci E, Alcalay M, Rosati R, Pasqualucci L, et al. Cytoplasmic nucleophosmin in acute myelogenous leukemia with a normal karyotype. *The New England journal of medicine* 2005;352:254-66.
152. Kristensen T, Moller MB, Friis L, Bergmann OJ, Preiss B. Npm1 mutation is a stable marker for minimal residual disease monitoring in acute myeloid leukaemia patients with increased sensitivity compared to wt1 expression. *Eur J Haematol* 2011;87:400-8.
153. Jain P, Kantarjian H, Patel K, Faderl S, Garcia-Manero G, Benjamini O, et al. Mutated npml in patients with acute myeloid leukemia in remission and relapse. *Leukemia & lymphoma* 2014;55:1337-44.
154. Kern W, Haferlach C, Haferlach T, Schnittger S. Monitoring of minimal residual disease in acute myeloid leukemia. *Cancer* 2008;112:4-16.
155. Lie SO, Abrahamsson J, Clausen N, Forestier E, Hasle H, Hovi L, et al. Long-term results in children with aml: Nopho-aml study group-report of three consecutive trials. *Leukemia* 2005;19:2090-100.
156. Zwaan CM, Kolb EA, Reinhardt D, Abrahamsson J, Adachi S, Aplenc R, et al. Collaborative efforts driving progress in pediatric acute myeloid leukemia. *Journal of clinical oncology : official journal of the American Society of Clinical Oncology* 2015;33:2949-62.

157. Tan Y, Du K, Luo Y, Shi J, Cao L, Zheng Y, et al. Superiority of preemptive donor lymphocyte infusion based on minimal residual disease in acute leukemia patients after allogeneic hematopoietic stem cell transplantation. *Transfusion* 2014;54:1493-500.
158. Mo XD, Zhang XH, Xu LP, Wang Y, Yan CH, Chen H, et al. Comparison of outcomes after donor lymphocyte infusion with or without prior chemotherapy for minimal residual disease in acute leukemia/myelodysplastic syndrome after allogeneic hematopoietic stem cell transplantation. *Annals of hematology* 2017;96:829-38.
159. Di Grazia C, Pozzi S, Geroldi S, Grasso R, Miglino M, Colombo N, et al. Wilms tumor 1 expression and pre-emptive immunotherapy in patients with acute myeloid leukemia undergoing an allogeneic hemopoietic stem cell transplantation. *Biology of blood and marrow transplantation : journal of the American Society for Blood and Marrow Transplantation* 2016;22:1242-6.
160. Hourigan CS, Gale RP, Gormley NJ, Ossenkoppele GJ, Walter RB. Measurable residual disease testing in acute myeloid leukaemia. *Leukemia* 2017;31:1482-90.
161. Yin JA, O'Brien MA, Hills RK, Daly SB, Wheatley K, Burnett AK. Minimal residual disease monitoring by quantitative rt-pcr in core binding factor aml allows risk stratification and predicts relapse: Results of the united kingdom mrc aml-15 trial. *Blood* 2012;120:2826-35.
162. Pigazzi M, Manara E, Buldini B, Beqiri V, Bisio V, Tregnago C, et al. Minimal residual disease monitored after induction therapy by rq-pcr can contribute to tailor treatment of patients with t(8;21) runx1-runx1t1 rearrangement. *Haematologica* 2015;100:e99-101.
163. Jourdan E, Boissel N, Chevret S, Delabesse E, Renneville A, Cornillet P, et al. Prospective evaluation of gene mutations and minimal residual disease in patients with core binding factor acute myeloid leukemia. *Blood* 2013;121:2213-23.
164. Perea G, Lasa A, Aventin A, Domingo A, Villamor N, Queipo de Llano MP, et al. Prognostic value of minimal residual disease (mrd) in acute myeloid leukemia (aml) with favorable cytogenetics [t(8;21) and inv(16)]. *Leukemia* 2006;20:87-94.
165. Maurillo L, Buccisano F, Spagnoli A, Del Poeta G, Panetta P, Neri B, et al. Monitoring of minimal residual disease in adult acute myeloid leukemia using peripheral blood as an alternative source to bone marrow. *Haematologica* 2007;92:605-11.
166. Zeijlemaker W, Kelder A, Oussoren-Brockhoff YJ, Scholten WJ, Snel AN, Veldhuizen D, et al. Peripheral blood minimal residual disease may replace bone marrow minimal residual disease as an immunophenotypic biomarker for impending relapse in acute myeloid leukemia. *Leukemia* 2016;30:708-15.

167. Kronke J, Schlenk RF, Jensen KO, Tschurtz F, Corbacioglu A, Gaidzik VI, et al. Monitoring of minimal residual disease in npml1-mutated acute myeloid leukemia: A study from the german-austrian acute myeloid leukemia study group. *Journal of clinical oncology : official journal of the American Society of Clinical Oncology* 2011;29:2709-16.
168. Willekens C, Blanchet O, Renneville A, Cornillet-Lefebvre P, Pautas C, Guieze R, et al. Prospective long-term minimal residual disease monitoring using rq-pcr in runx1-runx1t1-positive acute myeloid leukemia: Results of the french cbf-2006 trial. *Haematologica* 2016;101:328-35.
169. Martens AC, Schultz FW, Hagenbeek A. Nonhomogeneous distribution of leukemia in the bone marrow during minimal residual disease. *Blood* 1987;70:1073-8.
170. Miyamoto T, Nagafuji K, Akashi K, Harada M, Kyo T, Akashi T, et al. Persistence of multipotent progenitors expressing aml1/eto transcripts in long-term remission patients with t(8;21) acute myelogenous leukemia. *Blood* 1996;87:4789-96.
171. Tobal K, Liu Yin JA. Rt-pcr method with increased sensitivity shows persistence of pml-rara fusion transcripts in patients in long-term remission of apl. *Leukemia* 1998;12:1349-54.
172. Uemura S, Tamura A, Saito A, Hasegawa D, Nino N, Yokoi T, et al. Reemergence of translocation t(11;19)(q23;p13.1) in the absence of clinically overt leukemia. *International journal of hematology* 2017;106:847-51.
173. Karlsson L, Nyvold CG, Palmqvist L, Tierens A, Hasle H, Lausen B, et al. Quantification of fusion transcripts reveals slower treatment kinetics as compared with multiparameter flow cytometry during induction treatment of acute myeloid leukemia in children. *Vol.: Am Soc Hematology*, 2018.
174. Papaemmanuil E, Gerstung M, Bullinger L, Gaidzik VI, Paschka P, Roberts ND, et al. Genomic classification and prognosis in acute myeloid leukemia. *The New England journal of medicine* 2016;374:2209-21.
175. Farrar JE, Schuback HL, Ries RE, Wai D, Hampton OA, Trevino LR, et al. Genomic profiling of pediatric acute myeloid leukemia reveals a changing mutational landscape from disease diagnosis to relapse. *Cancer research* 2016;76:2197-205.
176. Gaksch L, Kashofer K, Heitzer E, Quehenberger F, Daga S, Hofer S, et al. Residual disease detection using targeted parallel sequencing predicts relapse in cytogenetically normal acute myeloid leukemia. *Am J Hematol* 2018;93:23-30.
177. Jongen-Lavrencic M, Grob T, Hanekamp D, Kavelaars FG, Al Hinai A, Zeilemaker A, et al. Molecular minimal residual disease in acute



- myeloid leukemia. *The New England journal of medicine* 2018;378:1189-99.
178. Getta BM, Devlin SM, Levine RL, Arcila ME, Mohanty AS, Zehir A, et al. Multicolor flow cytometry and multigene next-generation sequencing are complementary and highly predictive for relapse in acute myeloid leukemia after allogeneic transplantation. *Biology of blood and marrow transplantation : journal of the American Society for Blood and Marrow Transplantation* 2017;23:1064-71.
  179. Press RD, Eickelberg G, Froman A, Yang F, Stentz A, Flatley EM, et al. Next-generation sequencing-defined minimal residual disease before stem cell transplantation predicts acute myeloid leukemia relapse. *Am J Hematol* 2019.
  180. Bhatnagar B, Eisfeld AK, Nicolet D, Mrozek K, Blachly JS, Orwick S, et al. Persistence of dnmt3a r882 mutations during remission does not adversely affect outcomes of patients with acute myeloid leukaemia. *British journal of haematology* 2016;175:226-36.
  181. Gaidzik VI, Weber D, Paschka P, Kaumanns A, Krieger S, Corbacioglu A, et al. Dnmt3a mutant transcript levels persist in remission and do not predict outcome in patients with acute myeloid leukemia. *Leukemia* 2018;32:30-7.
  182. Jeziskova I, Musilova M, Culen M, Foltankova V, Dvorakova D, Mayer J, Racil Z. Distribution of mutations in dnmt3a gene and the suitability of mutations in r882 codon for mrd monitoring in patients with aml. *International journal of hematology* 2015;102:553-7.
  183. Rothenberg-Thurley M, Amler S, Goerlich D, Kohnke T, Konstandin NP, Schneider S, et al. Persistence of pre-leukemic clones during first remission and risk of relapse in acute myeloid leukemia. *Leukemia* 2018;32:1598-608.
  184. Wong TN, Miller CA, Klco JM, Petti A, Demeter R, Helton NM, et al. Rapid expansion of pre-existing non-leukemic hematopoietic clones frequently follows induction therapy for de novo aml. *Blood* 2015.
  185. Stein EM, DiNardo CD, Pollyea DA, Fathi AT, Roboz GJ, Altman JK, et al. Enasidenib in mutant idh2 relapsed or refractory acute myeloid leukemia. *Blood* 2017;130:722-31.
  186. Nakamura S, Yokoyama K, Shimizu E, Yusa N, Kondoh K, Ogawa M, et al. Prognostic impact of circulating tumor DNA status post-allogeneic hematopoietic stem cell transplantation in aml and mds. *Blood* 2019;133:2682-95.
  187. Waalkes A, Penewit K, Wood BL, Wu D, Salipante SJ. Ultrasensitive detection of acute myeloid leukemia minimal residual disease using single molecule molecular inversion probes. *Haematologica* 2017;102:1549-57.
  188. Kinde I, Wu J, Papadopoulos N, Kinzler KW, Vogelstein B. Detection and quantification of rare mutations with massively

- parallel sequencing. *Proceedings of the National Academy of Sciences of the United States of America* 2011;108:9530-5.
189. Onecha E, Linares M, Rapado I, Ruiz-Heredia Y, Martinez-Sanchez P, Cedena T, et al. Novel deep targeted sequencing method for minimal residual disease monitoring in acute myeloid leukemia. *Haematologica* 2018.
190. Zhou Y, Othus M, Walter RB, Estey EH, Wu D, Wood BL. Deep npml sequencing following allogeneic hematopoietic cell transplantation improves risk assessment in adults with npml-mutated aml. *Biology of blood and marrow transplantation : journal of the American Society for Blood and Marrow Transplantation* 2018;24:1615-20.
191. Delsing Malmberg E, Alm SJ, Nicklasson M, Lazarevic V, Ståhlman S, Samuelsson T, et al. Minimal residual disease assessed with deep sequencing of npml mutations predicts relapse after allogeneic stem cell transplant in aml. *Leukemia & lymphoma* 2018;Accepted for publication.
192. Della Starza I, Nunes V, Cavalli M, De Novi LA, Ilari C, Apicella V, et al. Comparative analysis between rq-pcr and digital-droplet-pcr of immunoglobulin/t-cell receptor gene rearrangements to monitor minimal residual disease in acute lymphoblastic leukaemia. *British journal of haematology* 2016;174:541-9.
193. Brunetti C, Anelli L, Zagaria A, Minervini A, Minervini CF, Casieri P, et al. Droplet digital pcr is a reliable tool for monitoring minimal residual disease in acute promyelocytic leukemia. *The Journal of molecular diagnostics : JMD* 2017;19:437-44.
194. Parkin B, Londono-Joshi A, Kang Q, Tewari M, Rhim AD, Malek SN. Ultrasensitive mutation detection identifies rare residual cells causing acute myelogenous leukemia relapse. *The Journal of clinical investigation* 2017;127:3484-95.
195. Mencia-Trinchant N, Hu Y, Alas MA, Ali F, Wouters BJ, Lee S, et al. Minimal residual disease monitoring of acute myeloid leukemia by massively multiplex digital pcr in patients with npml mutations. *The Journal of molecular diagnostics : JMD* 2017;19:537-48.
196. Bill M, Grimm J, Jentzsch M, Kloss L, Goldmann K, Schulz J, et al. Digital droplet pcr-based absolute quantification of pre-transplant npml mutation burden predicts relapse in acute myeloid leukemia patients. *Annals of hematology* 2018;97:1757-65.